

CD4041UB Types

CMOS Quad True/Complement Buffer

High Voltage Types (20-Volt Rating)

■ CD4041UB types are quad true/complement buffers consisting of n- and p-channel units having low channel resistance and high current (sourcing and sinking) capability. The CD4041UB is intended for use as a buffer, line driver, or CMOS-to-TTL driver. It can be used as an ultra-low power resistor-network driver for A/D and D/A conversion, as a transmission-line driver, and in other applications where high noise immunity and low power dissipation are primary design requirements.

The CD4041UB types are supplied in 14-lead hermetic dual-in-line ceramic packages (F3A suffix), 14-lead dual-in-line plastic packages (E suffix), 14-lead small-outline packages (M, MT, M96, and NSR suffixes), and 14-lead thin shrink small-outline packages (PW and PWR suffixes).

MAXIMUM RATINGS, Absolute-Maximum Values:

DC SUPPLY-VOLTAGE RANGE, (V_{DD})		
Voltages referenced to V_{SS} Terminal)		-0.5V to +20V
INPUT VOLTAGE RANGE, ALL INPUTS		-0.5V to $V_{DD} + 0.5V$
DC INPUT CURRENT, ANY ONE INPUT		$\pm 10mA$
POWER DISSIPATION PER PACKAGE (P_D):		
For $T_A = -55^\circ C$ to $+100^\circ C$		500mW
For $T_A = +100^\circ C$ to $+125^\circ C$		Derate Linearity at 12mW/ $^\circ C$ to 200mW
DEVICE DISSIPATION PER OUTPUT TRANSISTOR		
FOR $T_A =$ FULL PACKAGE-TEMPERATURE RANGE (All Package Types)		100mW
OPERATING-TEMPERATURE RANGE (T_A)		$-55^\circ C$ to $+125^\circ C$
STORAGE TEMPERATURE RANGE (T_{stg})		$-65^\circ C$ to $+150^\circ C$
LEAD TEMPERATURE (DURING SOLDERING):		
At distance $1/16 \pm 1/32$ inch ($1.59 \pm 0.79mm$) from case for 10s max		$+265^\circ C$

RECOMMENDED OPERATING CONDITIONS

For maximum reliability, nominal operating conditions should be selected so that operation is always within the following range:

CHARACTERISTIC	LIMITS		UNITS
	Min.	Max.	
Supply-Voltage Range (For $T_A =$ Full Package-Temperature Range)	3	18	V

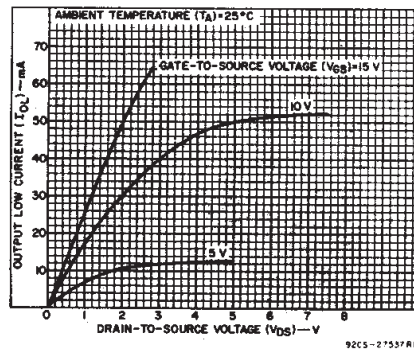

Fig. 2 – Typical output low (sink) current characteristics.

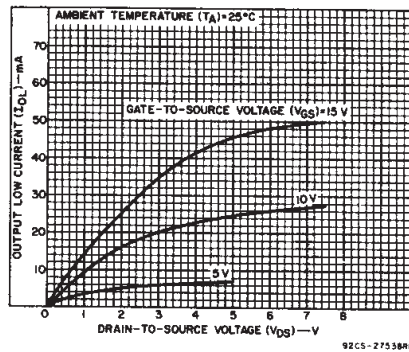

Fig. 3 – Minimum low (sink) current characteristics.

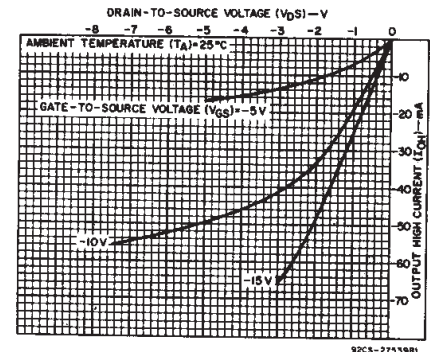

Fig. 4 – Typical output high (source) current characteristics.

Features:

- Balanced sink and source current; approximately 4 times standard "B" drive
- Equalized delay to true and complement outputs
- 100% tested for quiescent current at 20 V
- Maximum input current of 1 μA at 18 V over full package temperature range; 100 nA at 18 V and 25 $^\circ C$
- 5-V, 10-V, and 15-V parametric ratings
- Meets all requirements of JEDEC Tentative Standard No. 13B, "Standard Specifications for Description of 'B' Series CMOS Devices"

Applications:

- High current source/sink driver
- CMOS-to-DTL/TTL Converter Buffer
- Display driver
- MOS clock driver
- Resistor network driver (Ladder or weighted R)
- Buffer
- Transmission line driver

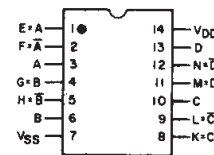
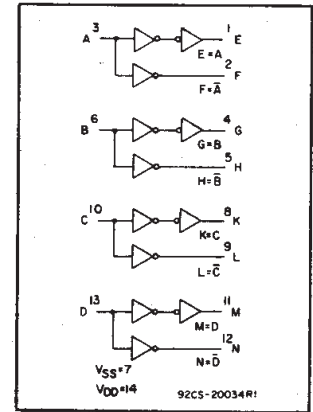

92CS-20755R1

TOP VIEW TERMINAL ASSIGNMENT

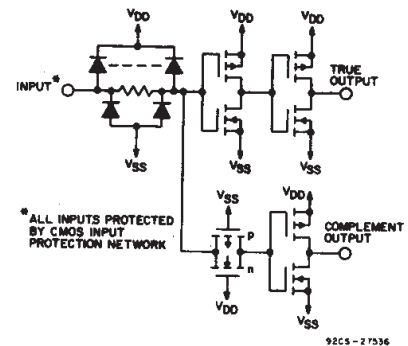

Fig. 1 – Schematic diagram 1 of 4 buffers.

3
COMMERCIAL CMOS
HIGH VOLTAGE ICs

CD4041UB Types

STATIC ELECTRICAL CHARACTERISTICS

CHARACTERISTIC	CONDITIONS			LIMITS AT INDICATED TEMPERATURES (°C)							UNITS
	V _O (V)	V _{IN} (V)	V _{DD} (V)	-55	-40	+85	+125	+25			
								Min.	Typ.	Max.	
Quiescent Device Current I _{DD} Max.	—	0.5	5	1	1	30	30	—	0.02	1	μA
	—	0.10	10	2	2	60	60	—	0.02	2	
	—	0.15	15	4	4	120	120	—	0.02	4	
	—	0.20	20	20	20	600	600	—	0.04	20	
Output Low (Sink) Current, I _{OL} Min.	0.4	0.5	5	2.1	1.8	1.3	1.2	1.6	3.2	—	mA
	0.5	0.10	10	6.25	5.6	4	3.5	5	10	—	
	1.5	0.15	15	24	23	15.5	13	19	38	—	
	4.6	0.5	5	-2.1	-1.8	-1.3	-1.2	-1.6	-3.2	—	
Output High (Source) Current, I _{OH} Min.	2.5	0.5	5	-8.4	-6.7	-5.3	-4.6	-6.4	-12.8	—	mA
	9.5	0.10	10	-6.25	-5.6	-4	-3.5	-5	-10	—	
	13.5	0.15	15	-24	-23	-15.5	-13	-19	-38	—	
Output Voltage: Low-Level, V _{OL} Max.	—	0.5	5	0.05				—	0	0.05	V
	—	0.10	10	0.05				—	0	0.05	
	—	0.15	15	0.05				—	0	0.05	
Output Voltage: High-Level, V _{OH} Min.	—	0.5	5	4.95				4.95	5	—	V
	—	0.10	10	9.95				9.95	10	—	
	—	0.15	15	14.95				14.95	15	—	
Input Low Voltage, V _{IL} Max.	0.5, 4.5	—	5	1				—	—	1	V
	1.9	—	10	2				—	—	2	
	1.5, 13.5	—	15	2.5				—	—	2.5	
Input High Voltage, V _{IH} Min.	0.5, 4.5	—	5	4				4	—	—	V
	1.9	—	10	8				8	—	—	
	1.5, 13.5	—	15	12.5				12.5	—	—	
Input Current, I _{IN} Max.	—	0.18	18	±0.1	±0.1	±1	±1	—	±10 ⁻⁵	±0.1	μA

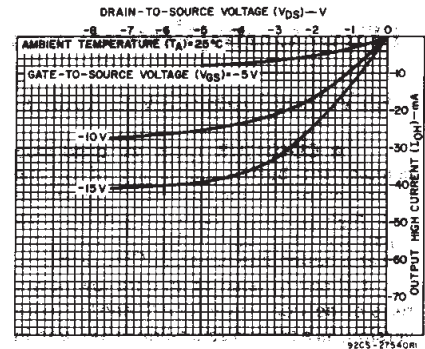

Fig. 5 - Minimum output high (source) current characteristics.

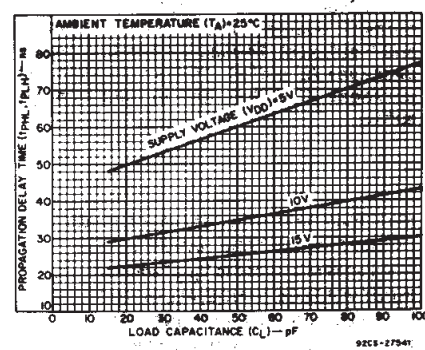

Fig. 6 - Typical propagation delay time vs. load capacitance.

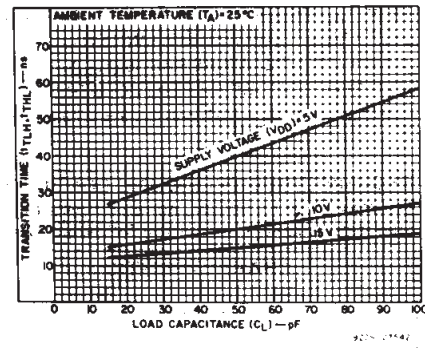

Fig. 7 - Typical transition time vs. load capacitance.

DYNAMIC ELECTRICAL CHARACTERISTICS at T_A = 25°C, Input t_r, t_f = 20 ns, C_L = 50 pF, R_L = 200 kΩ

CHARACTERISTIC		CONDITIONS		LIMITS		UNITS
		V _{DD} Volts		Typ.	Max.	
Propagation Delay Time:	t _{PHL}	5	60	120	ns	
	t _{PLH}	10	35	70		
	t _{PLH}	15	25	50		
Transition Time	t _{THL}	5	40	80	ns	
	t _{TLH}	10	20	40		
	t _{TLH}	15	15	30		
Input Capacitance	C _{IN}	Any Input	15	22.5	pF	

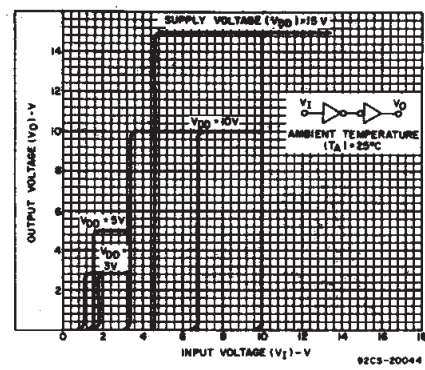

Fig. 8 - Minimum and maximum transfer characteristics - true output.

CD4041UB Types

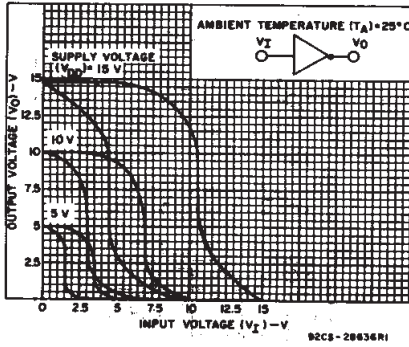

Fig. 9 - Minimum and maximum transfer characteristics - complement output.

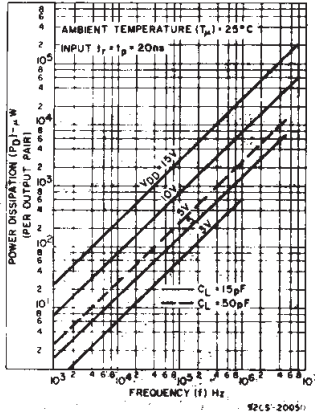

Fig. 11 - Typical power dissipation vs frequency per output pair.

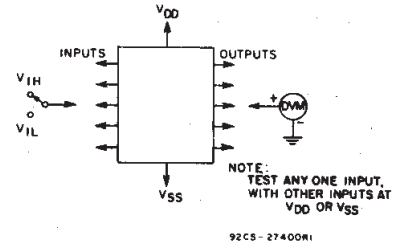

Fig. 13 - Input voltage test circuit.

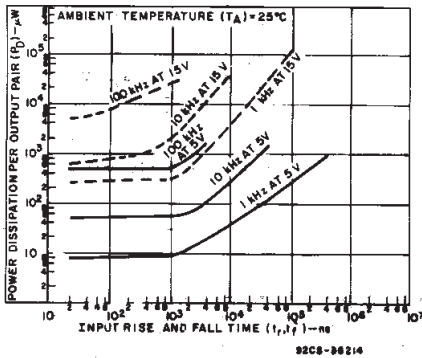

Fig. 10 - Typical power dissipation vs. input rise & fall time per output pair.

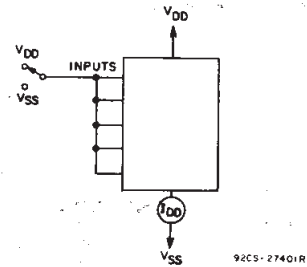

Fig. 12 - Quiescent device current test circuit.

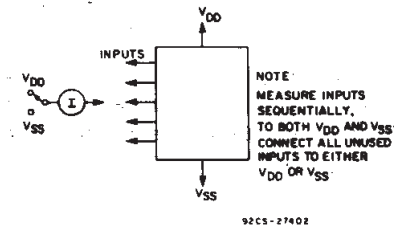
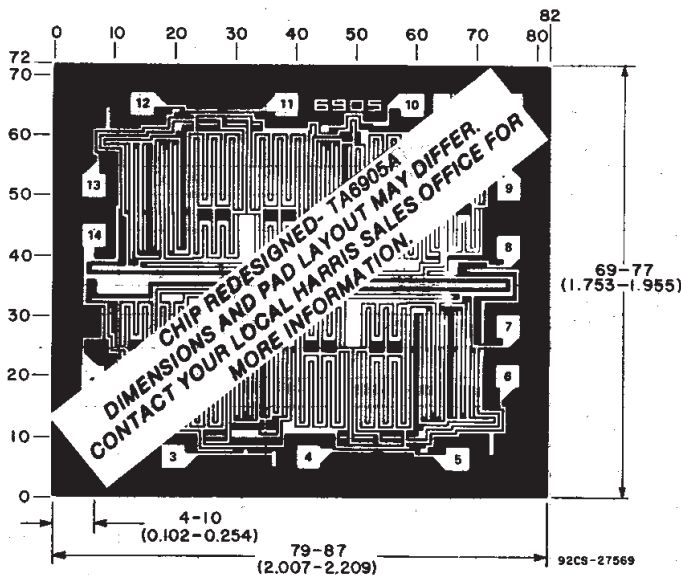

Fig. 14 - Input-leakage-current test circuit.

Dimensions and pad layout for the CD4041UBH



Dimensions in parentheses are in millimeters and are derived from the basic inch dimensions as indicated. Grid graduations are in mils (10^{-3} inch).

3
COMMERCIAL CMOS
HIGH VOLTAGE ICs

PACKAGING INFORMATION

Orderable part number	Status (1)	Material type (2)	Package Pins	Package qty Carrier	RoHS (3)	Lead finish/ Ball material (4)	MSL rating/ Peak reflow (5)	Op temp (°C)	Part marking (6)
CD4041UBE	Active	Production	PDIP (N) 14	25 TUBE	Yes	NIPDAU	N/A for Pkg Type	-55 to 125	CD4041UBE
CD4041UBE.A	Active	Production	PDIP (N) 14	25 TUBE	Yes	NIPDAU	N/A for Pkg Type	-55 to 125	CD4041UBE
CD4041UBF	Active	Production	CDIP (J) 14	25 TUBE	No	SNPB	N/A for Pkg Type	-55 to 125	CD4041UBF
CD4041UBF.A	Active	Production	CDIP (J) 14	25 TUBE	No	SNPB	N/A for Pkg Type	-55 to 125	CD4041UBF
CD4041UBF3A	Active	Production	CDIP (J) 14	25 TUBE	No	SNPB	N/A for Pkg Type	-55 to 125	CD4041UBF3A
CD4041UBF3A.A	Active	Production	CDIP (J) 14	25 TUBE	No	SNPB	N/A for Pkg Type	-55 to 125	CD4041UBF3A
CD4041UBM	Obsolete	Production	SOIC (D) 14	-	-	Call TI	Call TI	-55 to 125	CD4041UBM
CD4041UBM96	Active	Production	SOIC (D) 14	2500 LARGE T&R	Yes	NIPDAU	Level-1-260C-UNLIM	-55 to 125	CD4041UBM
CD4041UBM96.A	Active	Production	SOIC (D) 14	2500 LARGE T&R	Yes	NIPDAU	Level-1-260C-UNLIM	-55 to 125	CD4041UBM
CD4041UBMT	Obsolete	Production	SOIC (D) 14	-	-	Call TI	Call TI	-55 to 125	CD4041UBM
CD4041UBPW	Obsolete	Production	TSSOP (PW) 14	-	-	Call TI	Call TI	-55 to 125	CM041UB
CD4041UBPWR	Active	Production	TSSOP (PW) 14	2000 LARGE T&R	Yes	NIPDAU	Level-1-260C-UNLIM	-55 to 125	CM041UB
CD4041UBPWR.A	Active	Production	TSSOP (PW) 14	2000 LARGE T&R	Yes	NIPDAU	Level-1-260C-UNLIM	-55 to 125	CM041UB

⁽¹⁾ **Status:** For more details on status, see our [product life cycle](#).

⁽²⁾ **Material type:** When designated, preproduction parts are prototypes/experimental devices, and are not yet approved or released for full production. Testing and final process, including without limitation quality assurance, reliability performance testing, and/or process qualification, may not yet be complete, and this item is subject to further changes or possible discontinuation. If available for ordering, purchases will be subject to an additional waiver at checkout, and are intended for early internal evaluation purposes only. These items are sold without warranties of any kind.

⁽³⁾ **RoHS values:** Yes, No, RoHS Exempt. See the [TI RoHS Statement](#) for additional information and value definition.

⁽⁴⁾ **Lead finish/Ball material:** Parts may have multiple material finish options. Finish options are separated by a vertical ruled line. Lead finish/Ball material values may wrap to two lines if the finish value exceeds the maximum column width.

⁽⁵⁾ **MSL rating/Peak reflow:** The moisture sensitivity level ratings and peak solder (reflow) temperatures. In the event that a part has multiple moisture sensitivity ratings, only the lowest level per JEDEC standards is shown. Refer to the shipping label for the actual reflow temperature that will be used to mount the part to the printed circuit board.

⁽⁶⁾ **Part marking:** There may be an additional marking, which relates to the logo, the lot trace code information, or the environmental category of the part.

Multiple part markings will be inside parentheses. Only one part marking contained in parentheses and separated by a "~" will appear on a part. If a line is indented then it is a continuation of the previous line and the two combined represent the entire part marking for that device.

Important Information and Disclaimer: The information provided on this page represents TI's knowledge and belief as of the date that it is provided. TI bases its knowledge and belief on information provided by third parties, and makes no representation or warranty as to the accuracy of such information. Efforts are underway to better integrate information from third parties. TI has taken and continues to take reasonable steps to provide representative and accurate information but may not have conducted destructive testing or chemical analysis on incoming materials and chemicals. TI and TI suppliers consider certain information to be proprietary, and thus CAS numbers and other limited information may not be available for release.

In no event shall TI's liability arising out of such information exceed the total purchase price of the TI part(s) at issue in this document sold by TI to Customer on an annual basis.

OTHER QUALIFIED VERSIONS OF CD4041UB, CD4041UB-MIL :

- Catalog : [CD4041UB](#)
- Military : [CD4041UB-MIL](#)

NOTE: Qualified Version Definitions:

- Catalog - TI's standard catalog product
- Military - QML certified for Military and Defense Applications

TAPE AND REEL INFORMATION

QUADRANT ASSIGNMENTS FOR PIN 1 ORIENTATION IN TAPE

*All dimensions are nominal

Device	Package Type	Package Drawing	Pins	SPQ	Reel Diameter (mm)	Reel Width W1 (mm)	A0 (mm)	B0 (mm)	K0 (mm)	P1 (mm)	W (mm)	Pin1 Quadrant
CD4041UBM96	SOIC	D	14	2500	330.0	16.4	6.5	9.0	2.1	8.0	16.0	Q1
CD4041UBPWR	TSSOP	PW	14	2000	330.0	12.4	6.9	5.6	1.6	8.0	12.0	Q1

TAPE AND REEL BOX DIMENSIONS

*All dimensions are nominal

Device	Package Type	Package Drawing	Pins	SPQ	Length (mm)	Width (mm)	Height (mm)
CD4041UBM96	SOIC	D	14	2500	353.0	353.0	32.0
CD4041UBPWR	TSSOP	PW	14	2000	353.0	353.0	32.0

TUBE

*All dimensions are nominal

Device	Package Name	Package Type	Pins	SPQ	L (mm)	W (mm)	T (μm)	B (mm)
CD4041UBE	N	PDIP	14	25	506	13.97	11230	4.32
CD4041UBE	N	PDIP	14	25	506	13.97	11230	4.32
CD4041UBE.A	N	PDIP	14	25	506	13.97	11230	4.32
CD4041UBE.A	N	PDIP	14	25	506	13.97	11230	4.32



D0014A

PACKAGE OUTLINE

SOIC - 1.75 mm max height

SMALL OUTLINE INTEGRATED CIRCUIT



4220718/A 09/2016

NOTES:

1. All linear dimensions are in millimeters. Dimensions in parenthesis are for reference only. Dimensioning and tolerancing per ASME Y14.5M.
2. This drawing is subject to change without notice.
3. This dimension does not include mold flash, protrusions, or gate burrs. Mold flash, protrusions, or gate burrs shall not exceed 0.15 mm, per side.
4. This dimension does not include interlead flash. Interlead flash shall not exceed 0.43 mm, per side.
5. Reference JEDEC registration MS-012, variation AB.

EXAMPLE BOARD LAYOUT

D0014A

SOIC - 1.75 mm max height

SMALL OUTLINE INTEGRATED CIRCUIT



LAND PATTERN EXAMPLE
SCALE:8X



SOLDER MASK DETAILS

4220718/A 09/2016

NOTES: (continued)

- 6. Publication IPC-7351 may have alternate designs.
- 7. Solder mask tolerances between and around signal pads can vary based on board fabrication site.

EXAMPLE STENCIL DESIGN

D0014A

SOIC - 1.75 mm max height

SMALL OUTLINE INTEGRATED CIRCUIT



SOLDER PASTE EXAMPLE
BASED ON 0.125 mm THICK STENCIL
SCALE:8X

4220718/A 09/2016

NOTES: (continued)

8. Laser cutting apertures with trapezoidal walls and rounded corners may offer better paste release. IPC-7525 may have alternate design recommendations.
9. Board assembly site may have different recommendations for stencil design.

J 14

GENERIC PACKAGE VIEW
CDIP - 5.08 mm max height
CERAMIC DUAL IN LINE PACKAGE



Images above are just a representation of the package family, actual package may vary.
Refer to the product data sheet for package details.

4040083-5/G

J0014A



PACKAGE OUTLINE

CDIP - 5.08 mm max height

CERAMIC DUAL IN LINE PACKAGE



4214771/A 05/2017

NOTES:

1. All controlling linear dimensions are in inches. Dimensions in brackets are in millimeters. Any dimension in brackets or parenthesis are for reference only. Dimensioning and tolerancing per ASME Y14.5M.
2. This drawing is subject to change without notice.
3. This package is hermetically sealed with a ceramic lid using glass frit.
4. Index point is provided on cap for terminal identification only and on press ceramic glass frit seal only.
5. Falls within MIL-STD-1835 and GDIP1-T14.

EXAMPLE BOARD LAYOUT

J0014A

CDIP - 5.08 mm max height

CERAMIC DUAL IN LINE PACKAGE



LAND PATTERN EXAMPLE
NON-SOLDER MASK DEFINED
SCALE: 5X



4214771/A 05/2017

N (R-PDIP-T**)

PLASTIC DUAL-IN-LINE PACKAGE

16 PINS SHOWN



- NOTES:
- A. All linear dimensions are in inches (millimeters).
 - B. This drawing is subject to change without notice.
 - Falls within JEDEC MS-001, except 18 and 20 pin minimum body length (Dim A).
 - The 20 pin end lead shoulder width is a vendor option, either half or full width.

PW0014A



PACKAGE OUTLINE
TSSOP - 1.2 mm max height

SMALL OUTLINE PACKAGE



4220202/B 12/2023

NOTES:

1. All linear dimensions are in millimeters. Any dimensions in parenthesis are for reference only. Dimensioning and tolerancing per ASME Y14.5M.
2. This drawing is subject to change without notice.
3. This dimension does not include mold flash, protrusions, or gate burrs. Mold flash, protrusions, or gate burrs shall not exceed 0.15 mm per side.
4. This dimension does not include interlead flash. Interlead flash shall not exceed 0.25 mm per side.
5. Reference JEDEC registration MO-153.

EXAMPLE BOARD LAYOUT

PW0014A

TSSOP - 1.2 mm max height

SMALL OUTLINE PACKAGE



LAND PATTERN EXAMPLE
EXPOSED METAL SHOWN
SCALE: 10X



4220202/B 12/2023

NOTES: (continued)

- 6. Publication IPC-7351 may have alternate designs.
- 7. Solder mask tolerances between and around signal pads can vary based on board fabrication site.

EXAMPLE STENCIL DESIGN

PW0014A

TSSOP - 1.2 mm max height

SMALL OUTLINE PACKAGE

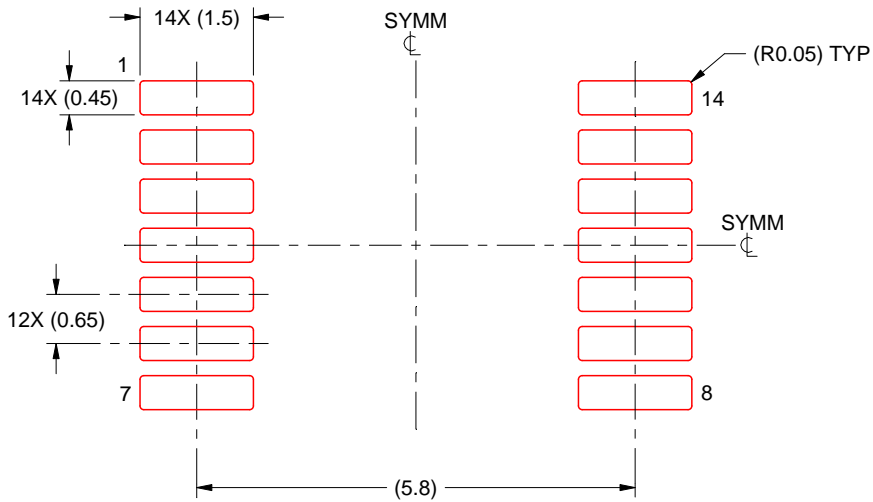

SOLDER PASTE EXAMPLE
BASED ON 0.125 mm THICK STENCIL
SCALE: 10X

4220202/B 12/2023

NOTES: (continued)

8. Laser cutting apertures with trapezoidal walls and rounded corners may offer better paste release. IPC-7525 may have alternate design recommendations.
9. Board assembly site may have different recommendations for stencil design.

IMPORTANT NOTICE AND DISCLAIMER

TI PROVIDES TECHNICAL AND RELIABILITY DATA (INCLUDING DATASHEETS), DESIGN RESOURCES (INCLUDING REFERENCE DESIGNS), APPLICATION OR OTHER DESIGN ADVICE, WEB TOOLS, SAFETY INFORMATION, AND OTHER RESOURCES "AS IS" AND WITH ALL FAULTS, AND DISCLAIMS ALL WARRANTIES, EXPRESS AND IMPLIED, INCLUDING WITHOUT LIMITATION ANY IMPLIED WARRANTIES OF MERCHANTABILITY, FITNESS FOR A PARTICULAR PURPOSE OR NON-INFRINGEMENT OF THIRD PARTY INTELLECTUAL PROPERTY RIGHTS.

These resources are intended for skilled developers designing with TI products. You are solely responsible for (1) selecting the appropriate TI products for your application, (2) designing, validating and testing your application, and (3) ensuring your application meets applicable standards, and any other safety, security, regulatory or other requirements.

These resources are subject to change without notice. TI grants you permission to use these resources only for development of an application that uses the TI products described in the resource. Other reproduction and display of these resources is prohibited. No license is granted to any other TI intellectual property right or to any third party intellectual property right. TI disclaims responsibility for, and you fully indemnify TI and its representatives against any claims, damages, costs, losses, and liabilities arising out of your use of these resources.

TI's products are provided subject to [TI's Terms of Sale](#), [TI's General Quality Guidelines](#), or other applicable terms available either on ti.com or provided in conjunction with such TI products. TI's provision of these resources does not expand or otherwise alter TI's applicable warranties or warranty disclaimers for TI products. Unless TI explicitly designates a product as custom or customer-specified, TI products are standard, catalog, general purpose devices.

TI objects to and rejects any additional or different terms you may propose.

Copyright © 2026, Texas Instruments Incorporated

Last updated 10/2025