

200-MHz GENERAL-PURPOSE CLOCK BUFFER, PCI-X COMPLIANT

Check for Samples: [CDCV304-EP](#)

FEATURES

- General-Purpose and PCI-X 1:4 Clock Buffer
- Operating Frequency
 - 0 MHz to 200 MHz General-Purpose
- Low Output Skew: <100 ps
- Distributes One Clock Input to One Bank of Four Outputs
- Output Enable Control that Drives Outputs Low when OE is Low
- Operates from Single 3.3-V Supply or 2.5-V Supply
- PCI-X Compliant
- 8-Pin TSSOP Package

SUPPORTS DEFENSE, AEROSPACE, AND MEDICAL APPLICATIONS

- Controlled Baseline
- One Assembly/Test Site
- One Fabrication Site
- Available in –40°C/105°C Temperature Range⁽¹⁾
- Extended Product Life Cycle
- Extended Product-Change Notification
- Product Traceability

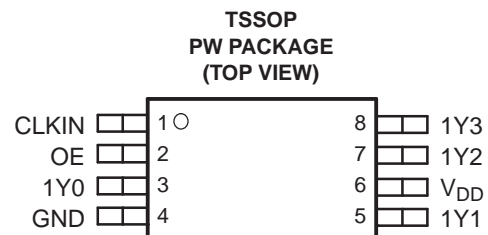

(1) Custom temperature ranges available

DESCRIPTION

The CDCV304 is a high-performance, low-skew, general-purpose PCI-X compliant clock buffer. It distributes one input clock signal (CLKIN) to the output clocks (1Y[0:3]). It is specifically designed for use with PCI-X applications. The CDCV304 operates at 3.3 V and 2.5 V and is therefore compliant to the 3.3-V PCI-X specifications.

The CDCV304 is characterized for operation from –40°C to 105°C.

FUNCTIONAL BLOCK DIAGRAM

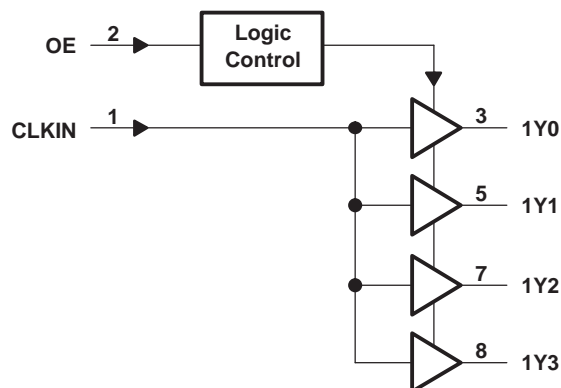
Table 1. FUNCTION TABLE

INPUTS		OUTPUTS
CLKIN	OE	1Y[0:3]
L	L	L
H	L	L
L	H	L
H	H	H



Please be aware that an important notice concerning availability, standard warranty, and use in critical applications of Texas Instruments semiconductor products and disclaimers thereto appears at the end of this data sheet.



This integrated circuit can be damaged by ESD. Texas Instruments recommends that all integrated circuits be handled with appropriate precautions. Failure to observe proper handling and installation procedures can cause damage.

ESD damage can range from subtle performance degradation to complete device failure. Precision integrated circuits may be more susceptible to damage because very small parametric changes could cause the device not to meet its published specifications.

Table 2. ORDERING INFORMATION⁽¹⁾

T _A	PACKAGE	ORDERABLE PART NUMBER	TOP-SIDE MARKING	VID NUMBER
–40°C to 105°C	TSSOP - PW	CDCV304TPWREP	C304T	V62/12618-01XE

(1) For the most current package and ordering information, see the Package Option Addendum at the end of this document, or see the TI Web site at www.ti.com.

TERMINAL FUNCTIONS

TERMINAL		I/O	DESCRIPTION
NAME	NO.		
1Y[0:3]	3, 5, 7, 8	O	Buffered output clocks
CLKIN	1	I	Input reference frequency
GND	4	Power	Ground
OE	2	I	Output enable control
V _{DD}	6	Power	Supply

ABSOLUTE MAXIMUM RATINGS

over operating free-air temperature range (unless otherwise noted) ⁽¹⁾

	UNIT
Supply voltage range, V _{DD}	–0.5 V to 4.3 V
Input voltage range, V _I ⁽²⁾ ⁽³⁾	–0.5 V to V _{DD} + 0.5 V
Output voltage range, V _O ⁽²⁾ ⁽³⁾	–0.5 V to V _{DD} + 0.5 V
Input clamp current, I _{IK} (V _I < 0 or V _I > V _{DD})	±50 mA
Output clamp current, I _{OK} (V _O < 0 or V _O > V _{DD})	±50 mA
Continuous total output current, I _O (V _O = 0 to V _{DD})	±50 mA
Storage temperature range T _{stg}	–65°C to 150°C

- (1) Stresses beyond those listed under “absolute maximum ratings” may cause permanent damage to the device. These are stress ratings only, and functional operation of the device at these or any other conditions beyond those indicated under “recommended operating conditions” is not implied. Exposure to absolute-maximum-rated conditions for extended periods may affect device reliability.
- (2) The input and output negative voltage ratings may be exceeded if the input and output clamp-current ratings are observed.
- (3) This value is limited to 4.6 V maximum.

THERMAL INFORMATION

THERMAL METRIC ⁽¹⁾		CDCV304		UNITS
		PW		
		8 PINS		
θ_{JA}	Junction-to-ambient thermal resistance ⁽²⁾	175.8		°C/W
θ_{JCTop}	Junction-to-case (top) thermal resistance ⁽³⁾	61.8		
θ_{JB}	Junction-to-board thermal resistance ⁽⁴⁾	104.3		
ψ_{JT}	Junction-to-top characterization parameter ⁽⁵⁾	7.7		
ψ_{JB}	Junction-to-board characterization parameter ⁽⁶⁾	102.6		

- (1) For more information about traditional and new thermal metrics, see the *IC Package Thermal Metrics* application report, [SPRA953](#).
- (2) The junction-to-ambient thermal resistance under natural convection is obtained in a simulation on a JEDEC-standard, high-K board, as specified in JESD51-7, in an environment described in JESD51-2a.
- (3) The junction-to-case (top) thermal resistance is obtained by simulating a cold plate test on the package top. No specific JEDEC-standard test exists, but a close description can be found in the ANSI SEMI standard G30-88.
- (4) The junction-to-board thermal resistance is obtained by simulating in an environment with a ring cold plate fixture to control the PCB temperature, as described in JESD51-8.
- (5) The junction-to-top characterization parameter, ψ_{JT} , estimates the junction temperature of a device in a real system and is extracted from the simulation data for obtaining θ_{JA} , using a procedure described in JESD51-2a (sections 6 and 7).
- (6) The junction-to-board characterization parameter, ψ_{JB} , estimates the junction temperature of a device in a real system and is extracted from the simulation data for obtaining θ_{JA} , using a procedure described in JESD51-2a (sections 6 and 7).

RECOMMENDED OPERATING CONDITIONS

		MIN	NOM	MAX	UNIT
Supply voltage, V_{DD}		2.3		3.6	V
Low-level input voltage, V_{IL}				$0.3 \times V_{DD}$	V
High-level input voltage, V_{IH}		$0.7 \times V_{DD}$			V
Input voltage, V_I		0		V_{DD}	V
High-level output current, I_{OH}	$V_{DD} = 2.5\text{ V}$			-12	mA
	$V_{DD} = 3.3\text{ V}$			-24	
Low-level output current, I_{OL}	$V_{DD} = 2.5\text{ V}$			12	mA
	$V_{DD} = 3.3\text{ V}$			24	
Operating free-air temperature, T_A		-40		105	°C

TIMING REQUIREMENTS

over operating free-air temperature range (unless otherwise noted)

PARAMETER		TEST CONDITIONS	MIN	TYP	MAX	UNIT
f_{clk}	Clock frequency		0		200	MHz

ELECTRICAL CHARACTERISTICS

over recommended operating free-air temperature range (unless otherwise noted)

PARAMETER		TEST CONDITIONS		MIN	TYP ⁽¹⁾	MAX	UNIT
V_{IK}	Input voltage	$V_{DD} = 3\text{ V}$,	$I_I = -18\text{ mA}$			-1.2	V
V_{OH}	High-level output voltage	$V_{DD} = \text{min to max}$,	$I_{OH} = -1\text{ mA}$	$V_{DD} - 0.3$			V
		$V_{DD} = 2.3\text{ V}$,	$I_{OH} = -8\text{ mA}$	1.78			
		$V_{DD} = 3\text{ V}$,	$I_{OH} = -24\text{ mA}$	1.90			
		$V_{DD} = 3\text{ V}$,	$I_{OH} = -12\text{ mA}$	2.30			
V_{OL}	Low-level output voltage	$V_{DD} = 2.3\text{ V}$,	$I_{OL} = 8\text{ mA}$			0.51	V
		$V_{DD} = \text{min to max}$,	$I_{OL} = 1\text{ mA}$			0.20	
		$V_{DD} = 3\text{ V}$,	$I_{OL} = 24\text{ mA}$			0.84	
		$V_{DD} = 3\text{ V}$,	$I_{OL} = 12\text{ mA}$			0.60	
I_{OH}	High-level output current	$V_{DD} = 3\text{ V}$,	$V_O = 1\text{ V}$	-45			mA
		$V_{DD} = 3.3\text{ V}$,	$V_O = 1.65\text{ V}$			-55	
I_{OL}	Low-level output current	$V_{DD} = 3\text{ V}$,	$V_O = 2\text{ V}$	54			mA
		$V_{DD} = 3.3\text{ V}$,	$V_O = 1.65\text{ V}$			70	
I_I	Input current	$V_I = V_O \text{ or } V_{DD}$				± 5	μA
I_{DD}	Dynamic current, see	$f = 67\text{ MHz}$,	$V_{DD} = 2.7\text{ V}$			28	mA
		$f = 67\text{ MHz}$,	$V_{DD} = 3.6\text{ V}$			37	
C_I	Input capacitance	$V_{DD} = 3.3\text{ V}$,	$V_I = 0\text{ V or } V_{DD}$		3		pF
C_O	Output capacitance	$V_{DD} = 3.3\text{ V}$,	$V_I = 0\text{ V or } V_{DD}$		3.2		pF

(1) All typical values are with respect to nominal V_{DD} and $T_A = 25^\circ\text{C}$.

SWITCHING CHARACTERISTICS

 $V_{DD} = 2.5\text{ V} \pm 10\%$, $C_L = 10\text{ pF}$ (unless otherwise noted)

PARAMETER		TEST CONDITIONS	MIN	TYP ⁽¹⁾	MAX	UNIT
t_{PLH}	Low-to-high propagation delay	See Figure 1 and Figure 2	2	2.9	4.5	ns
t_{PHL}	High-to-low propagation delay		2	3	4.5	
$t_{sk(o)}$	Output skew ⁽²⁾	See Figure 3		50	150	ps
t_r	Output rise slew rate ⁽³⁾		1	2.2	4	V/ns
t_f	Output fall slew rate ⁽³⁾		1	2.2	4	V/ns

(1) All typical values are with respect to nominal V_{DD} .

(2) The $t_{sk(o)}$ specification is only valid for equal loading of all outputs and $T_A = -40^\circ\text{C}$ to 85°C .

(3) This symbol is according to PCI-X terminology.

SWITCHING CHARACTERISTICS

 $V_{DD} = 3.3\text{ V} \pm 10\%$, $C_L = 10\text{ pF}$ (unless otherwise noted)

PARAMETER		TEST CONDITIONS	MIN	TYP ⁽¹⁾	MAX	UNIT
t_{PLH}	Low-to-high propagation delay	See Figure 1 and Figure 2	1.8	2.4	3.8	ns
t_{PHL}	High-to-low propagation delay		1.8	2.5	3.8	
$t_{sk(o)}$	Output skew ⁽²⁾			50	100	ps
t_{jitter}	Additive phase jitter from input to output 1Y0	12 kHz to 5 MHz, $f_{out} = 30.72\text{ MHz}$		63		fs rms
		12 kHz to 20 MHz, $f_{out} = 125\text{ MHz}$		56		
$t_{sk(p)}$	Pulse skew	$V_{IH} = V_{DD}$, $V_{IL} = 0\text{ V}$		180		ps
$t_{sk(pr)}$	Process skew			0.2		ns
$t_{sk(pp)}$	Part-to-part skew			0.25		ns
t_{high}	Clock high time, see Figure 4	66 MHz	6			ns
		140 MHz	2.2			
t_{low}	Clock low time, see Figure 4	66 MHz	6			ns
		140 MHz	3			
t_r	Output rise slew rate ⁽³⁾		1	2.7	4	V/ns
t_f	Output fall slew rate ⁽³⁾		1	2.7	4	V/ns

(1) All typical values are with respect to nominal V_{DD} .

(2) The $t_{sk(o)}$ specification is only valid for equal loading of all outputs and $T_A = -40^\circ\text{C}$ to 85°C .

(3) This symbol is according to PCI-X terminology.

PARAMETER MEASUREMENT INFORMATION

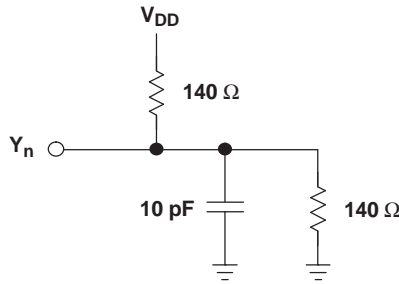

Figure 1. Test Load Circuit

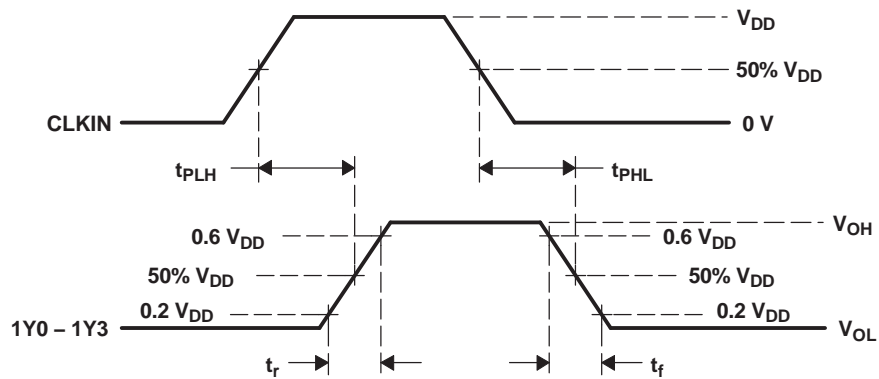

Figure 2. Voltage Waveforms Propagation Delay (t_{pd}) Measurements

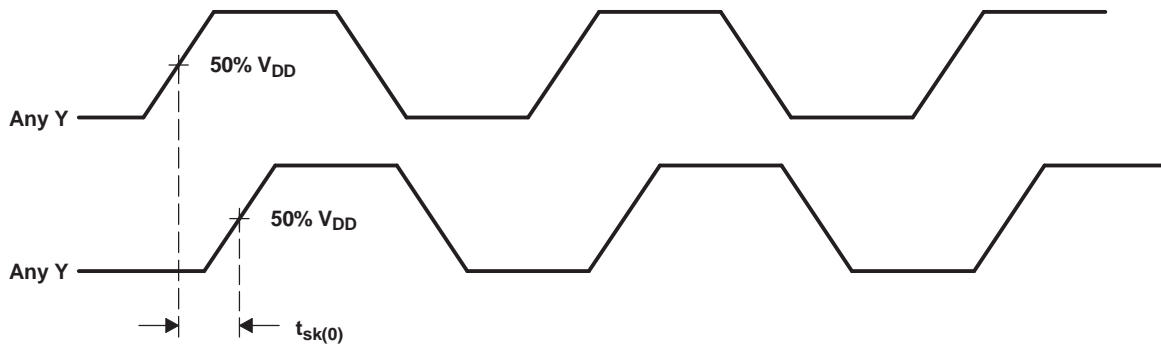
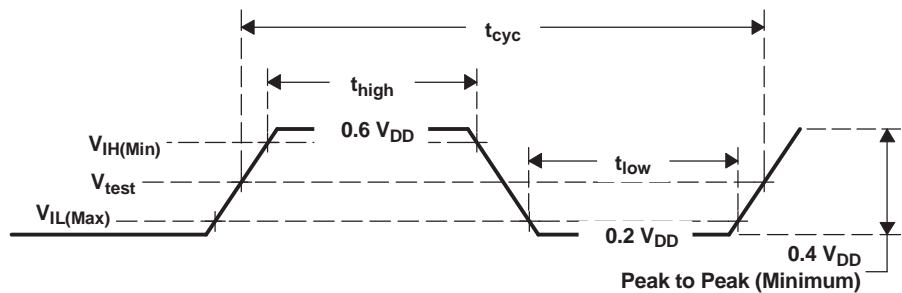

Figure 3. Output Skew

PARAMETER	VALUE	UNIT
$V_{IH}(\text{Min})$	$0.5 V_{DD}$	V
$V_{IL}(\text{Max})$	$0.35 V_{DD}$	V
V_{test}	$0.4 V_{DD}$	V



A. All parameters in Figure 4 are according to PCI-X 1.0 specifications.

Figure 4. Clock Waveform

HIGH-LEVEL OUTPUT VOLTAGE
vs
HIGH-LEVEL OUTPUT CURRENT

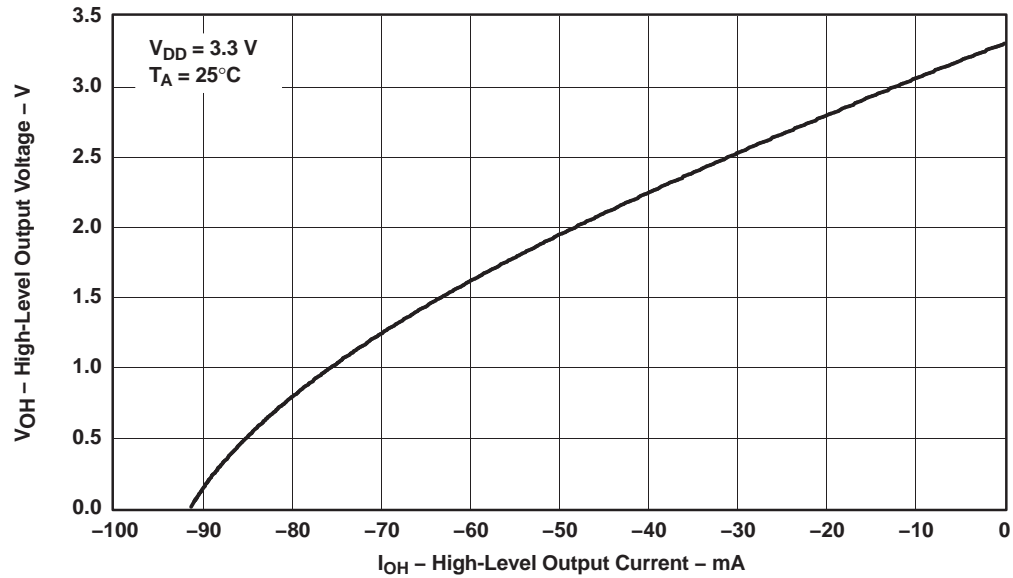

Figure 5.

LOW-LEVEL OUTPUT VOLTAGE
vs
LOW-LEVEL OUTPUT CURRENT

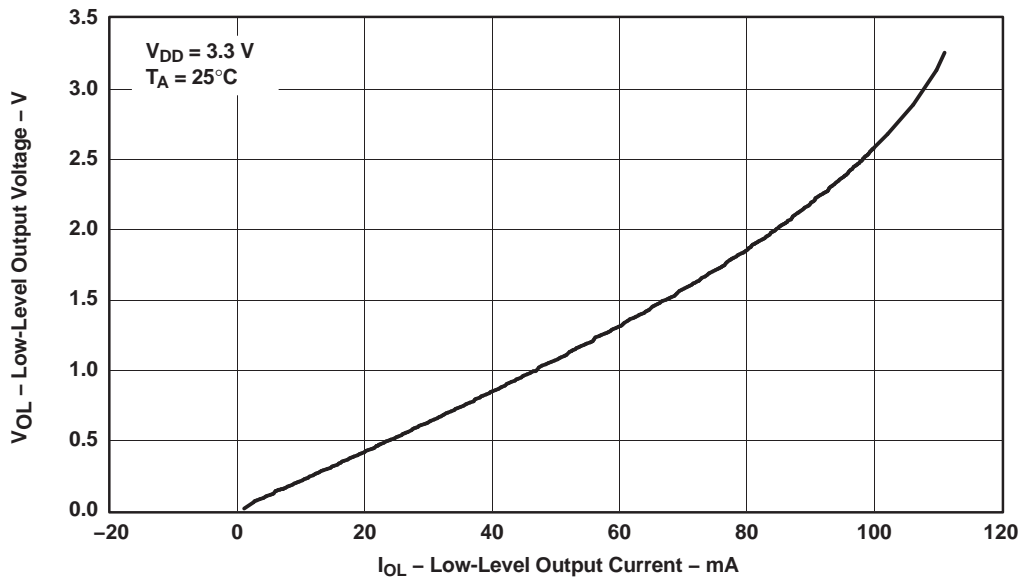

Figure 6.

PACKAGING INFORMATION

Orderable part number	Status (1)	Material type (2)	Package Pins	Package qty Carrier	RoHS (3)	Lead finish/ Ball material (4)	MSL rating/ Peak reflow (5)	Op temp (°C)	Part marking (6)
CDCV304TPWREP	Active	Production	TSSOP (PW) 8	2000 LARGE T&R	Yes	NIPDAU	Level-1-260C-UNLIM	-40 to 105	C304T
CDCV304TPWREP.A	Active	Production	TSSOP (PW) 8	2000 LARGE T&R	Yes	NIPDAU	Level-1-260C-UNLIM	-40 to 105	C304T
V62/12618-01XE	Active	Production	TSSOP (PW) 8	2000 LARGE T&R	Yes	NIPDAU	Level-1-260C-UNLIM	-40 to 105	C304T

(1) **Status:** For more details on status, see our [product life cycle](#).

(2) **Material type:** When designated, preproduction parts are prototypes/experimental devices, and are not yet approved or released for full production. Testing and final process, including without limitation quality assurance, reliability performance testing, and/or process qualification, may not yet be complete, and this item is subject to further changes or possible discontinuation. If available for ordering, purchases will be subject to an additional waiver at checkout, and are intended for early internal evaluation purposes only. These items are sold without warranties of any kind.

(3) **RoHS values:** Yes, No, RoHS Exempt. See the [TI RoHS Statement](#) for additional information and value definition.

(4) **Lead finish/Ball material:** Parts may have multiple material finish options. Finish options are separated by a vertical ruled line. Lead finish/Ball material values may wrap to two lines if the finish value exceeds the maximum column width.

(5) **MSL rating/Peak reflow:** The moisture sensitivity level ratings and peak solder (reflow) temperatures. In the event that a part has multiple moisture sensitivity ratings, only the lowest level per JEDEC standards is shown. Refer to the shipping label for the actual reflow temperature that will be used to mount the part to the printed circuit board.

(6) **Part marking:** There may be an additional marking, which relates to the logo, the lot trace code information, or the environmental category of the part.

Multiple part markings will be inside parentheses. Only one part marking contained in parentheses and separated by a "-" will appear on a part. If a line is indented then it is a continuation of the previous line and the two combined represent the entire part marking for that device.

Important Information and Disclaimer: The information provided on this page represents TI's knowledge and belief as of the date that it is provided. TI bases its knowledge and belief on information provided by third parties, and makes no representation or warranty as to the accuracy of such information. Efforts are underway to better integrate information from third parties. TI has taken and continues to take reasonable steps to provide representative and accurate information but may not have conducted destructive testing or chemical analysis on incoming materials and chemicals. TI and TI suppliers consider certain information to be proprietary, and thus CAS numbers and other limited information may not be available for release.

In no event shall TI's liability arising out of such information exceed the total purchase price of the TI part(s) at issue in this document sold by TI to Customer on an annual basis.

OTHER QUALIFIED VERSIONS OF CDCV304-EP :

- Catalog : [CDCV304](#)

NOTE: Qualified Version Definitions:

- Catalog - TI's standard catalog product

TAPE AND REEL INFORMATION

QUADRANT ASSIGNMENTS FOR PIN 1 ORIENTATION IN TAPE

*All dimensions are nominal

Device	Package Type	Package Drawing	Pins	SPQ	Reel Diameter (mm)	Reel Width W1 (mm)	A0 (mm)	B0 (mm)	K0 (mm)	P1 (mm)	W (mm)	Pin1 Quadrant
CDCV304TPWREP	TSSOP	PW	8	2000	330.0	12.4	7.0	3.6	1.6	8.0	12.0	Q1

TAPE AND REEL BOX DIMENSIONS

*All dimensions are nominal

Device	Package Type	Package Drawing	Pins	SPQ	Length (mm)	Width (mm)	Height (mm)
CDCV304TPWREP	TSSOP	PW	8	2000	353.0	353.0	32.0

PW0008A



PACKAGE OUTLINE

TSSOP - 1.2 mm max height

SMALL OUTLINE PACKAGE



4221848/A 02/2015

NOTES:

- All linear dimensions are in millimeters. Any dimensions in parenthesis are for reference only. Dimensioning and tolerancing per ASME Y14.5M.
- This drawing is subject to change without notice.
- This dimension does not include mold flash, protrusions, or gate burrs. Mold flash, protrusions, or gate burrs shall not exceed 0.15 mm per side.
- This dimension does not include interlead flash. Interlead flash shall not exceed 0.25 mm per side.
- Reference JEDEC registration MO-153, variation AA.

EXAMPLE BOARD LAYOUT

PW0008A

TSSOP - 1.2 mm max height

SMALL OUTLINE PACKAGE



LAND PATTERN EXAMPLE
SCALE:10X



SOLDER MASK DETAILS
NOT TO SCALE

4221848/A 02/2015

NOTES: (continued)

- 6. Publication IPC-7351 may have alternate designs.
- 7. Solder mask tolerances between and around signal pads can vary based on board fabrication site.

EXAMPLE STENCIL DESIGN

PW0008A

TSSOP - 1.2 mm max height

SMALL OUTLINE PACKAGE



SOLDER PASTE EXAMPLE
BASED ON 0.125 mm THICK STENCIL
SCALE:10X

4221848/A 02/2015

NOTES: (continued)

8. Laser cutting apertures with trapezoidal walls and rounded corners may offer better paste release. IPC-7525 may have alternate design recommendations.
9. Board assembly site may have different recommendations for stencil design.

IMPORTANT NOTICE AND DISCLAIMER

TI PROVIDES TECHNICAL AND RELIABILITY DATA (INCLUDING DATASHEETS), DESIGN RESOURCES (INCLUDING REFERENCE DESIGNS), APPLICATION OR OTHER DESIGN ADVICE, WEB TOOLS, SAFETY INFORMATION, AND OTHER RESOURCES "AS IS" AND WITH ALL FAULTS, AND DISCLAIMS ALL WARRANTIES, EXPRESS AND IMPLIED, INCLUDING WITHOUT LIMITATION ANY IMPLIED WARRANTIES OF MERCHANTABILITY, FITNESS FOR A PARTICULAR PURPOSE OR NON-INFRINGEMENT OF THIRD PARTY INTELLECTUAL PROPERTY RIGHTS.

These resources are intended for skilled developers designing with TI products. You are solely responsible for (1) selecting the appropriate TI products for your application, (2) designing, validating and testing your application, and (3) ensuring your application meets applicable standards, and any other safety, security, regulatory or other requirements.

These resources are subject to change without notice. TI grants you permission to use these resources only for development of an application that uses the TI products described in the resource. Other reproduction and display of these resources is prohibited. No license is granted to any other TI intellectual property right or to any third party intellectual property right. TI disclaims responsibility for, and you fully indemnify TI and its representatives against any claims, damages, costs, losses, and liabilities arising out of your use of these resources.

TI's products are provided subject to [TI's Terms of Sale](#), [TI's General Quality Guidelines](#), or other applicable terms available either on ti.com or provided in conjunction with such TI products. TI's provision of these resources does not expand or otherwise alter TI's applicable warranties or warranty disclaimers for TI products. Unless TI explicitly designates a product as custom or customer-specified, TI products are standard, catalog, general purpose devices.

TI objects to and rejects any additional or different terms you may propose.

Copyright © 2025, Texas Instruments Incorporated

Last updated 10/2025