

# CSD25211W1015, P-Channel NexFET™ Power MOSFET

## 1 Features

- Ultra-low on resistance
- Ultra-low  $Q_g$  and  $Q_{gd}$
- Small footprint 1.0 mm × 1.5 mm
- Low profile 0.62 mm height
- Pb Free
- Gate-source voltage clamp
- Gate ESD protection – 3 kV
- RoHS compliant
- Halogen free

## 2 Applications

- Battery Management
- Load Switch
- Battery Protection

## 3 Description

The device is designed to deliver the lowest on resistance and gate charge in the smallest outline possible with excellent thermal characteristics in an ultra-low profile.

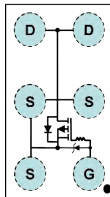
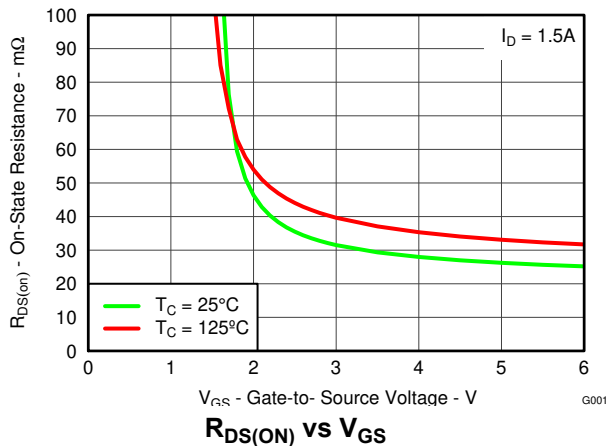


Figure 3-1. Top View



## Product Summary

$T_A = 25^\circ\text{C}$ unless otherwise stated		TYPICAL VALUE	UNIT
$V_{DS}$	Drain-to-Source Voltage	-20	V
$Q_g$	Gate Charge Total (-4.5V)	3.4	nC
$Q_{gd}$	Gate Charge Gate to Drain	0.2	nC
$R_{DS(on)}$	Drain-to-Source On Resistance	$V_{GS} = -2.5\text{ V}$	36 mΩ
		$V_{GS} = -4.5\text{ V}$	27 mΩ
$V_{GS(th)}$	Voltage Threshold	-0.8	V

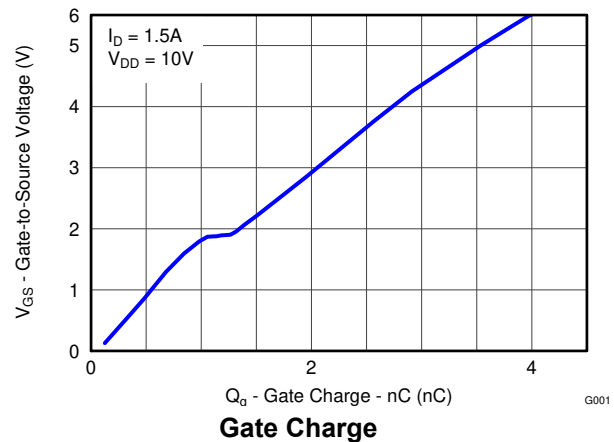
## Ordering Information

Device	Package	Media	Qty	Ship
CSD25211W1015	1 × 1.5 Wafer Level Package	7-inch reel	3000	Tape and Reel

## Absolute Maximum Ratings

$T_A = 25^\circ\text{C}$ unless otherwise stated		VALUE	UNIT
$V_{DS}$	Drain-to-Source Voltage	-20	V
$V_{GS}$	Gate-to-Source Voltage	-6	V
$I_D$	Continuous Drain Current, $T_A = 25^\circ\text{C}^{(1)}$	-3.2	A
$I_{DM}$	Pulsed Drain Current, $T_A = 25^\circ\text{C}^{(2)}$	-9.5	A
$I_G$	Continuous Gate Current, $T_A = 25^\circ\text{C}$	-0.5	A
	Pulsed Gate Current	-7	A
$P_D$	Power Dissipation <sup>(1)</sup>	1	W
$T_{STG}$	Storage Temperature Range	-55 to 150	$^\circ\text{C}$
$T_J$	Operating Junction Temperature Range		

- (1) Typical  $R_{\theta JA} = 119^\circ\text{C/W}$  on 1 inch<sup>2</sup> of 2 oz. Cu on 0.06-inch thick FR4 PCB.
- (2) Pulse width  $\leq 10\ \mu\text{s}$ , duty cycle  $\leq 2\%$



## Table of Contents

<b>1 Features</b> .....	<b>1</b>	8.2 Land Pattern Recommendation.....	<b>9</b>
<b>2 Applications</b> .....	<b>1</b>	<b>9 Electrostatic Discharge Caution</b> .....	<b>9</b>
<b>3 Description</b> .....	<b>1</b>	<b>10 Device and Documentation Support</b> .....	<b>10</b>
<b>4 Revision History</b> .....	<b>2</b>	10.1 Third-Party Products Disclaimer.....	<b>10</b>
<b>5 Electrical Characteristics</b> .....	<b>3</b>	10.2 Receiving Notification of Documentation Updates..	<b>10</b>
<b>6 Thermal Characteristics</b> .....	<b>4</b>	10.3 Support Resources.....	<b>10</b>
<b>7 Typical MOSFET Characteristics</b> .....	<b>5</b>	10.4 Trademarks.....	<b>10</b>
<b>8 Mechanical Data</b> .....	<b>8</b>	10.5 Electrostatic Discharge Caution.....	<b>10</b>
8.1 CSD25211W1015 Package Dimensions.....	<b>8</b>	10.6 Glossary.....	<b>10</b>

## 4 Revision History

NOTE: Page numbers for previous revisions may differ from page numbers in the current version.

### Changes from Revision A (January 2014) to Revision B (September 2022)

**Page**

- In the Absolute Maximum Ratings table Continuous Drain Current was changed to Continuous Gate Current.....**1**
- In the Absolute Maximum Ratings table Pulsed Drain Current was changed to Pulsed Gate Current.....**1**

## 5 Electrical Characteristics

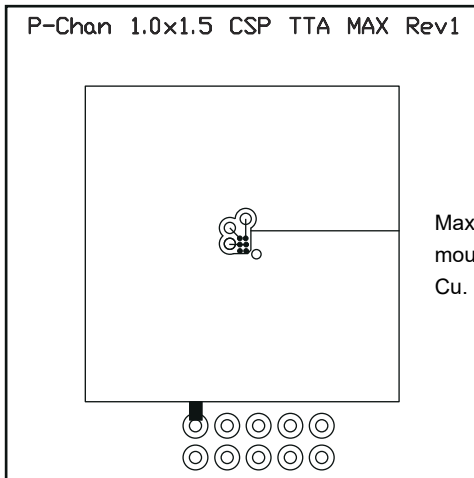
( $T_A = 25^\circ\text{C}$  unless otherwise stated)

PARAMETER		TEST CONDITIONS	MIN	TYP	MAX	UNIT
<b>Static Characteristics</b>						
$BV_{DSS}$	Drain-to-Source Voltage	$V_{GS} = 0\text{ V}, I_D = -250\ \mu\text{A}$	-20			V
$BV_{GSS}$	Gate-to-Source Voltage	$V_{DS} = 0\text{ V}, I_G = -250\ \mu\text{A}$	-6.1		-7.2	V
$I_{DSS}$	Drain-to-Source Leakage Current	$V_{GS} = 0\text{ V}, V_{DS} = -16\text{ V}$			-1	$\mu\text{A}$
$I_{GSS}$	Gate-to-Source Leakage Current	$V_{DS} = 0\text{ V}, V_{GS} = -6\text{ V}$			-100	nA
$V_{GS(th)}$	Gate-to-Source Threshold Voltage	$V_{DS} = V_{GS}, I_D = -250\ \mu\text{A}$	-0.5	-0.8	-1.1	V
$R_{DS(on)}$	Drain-to-Source On Resistance	$V_{GS} = -2.5\text{ V}, I_D = -1.5\text{ A}$		36	44	$\text{m}\Omega$
		$V_{GS} = -4.5\text{ V}, I_D = -1.5\text{ A}$		27	33	$\text{m}\Omega$
$g_{fs}$	Transconductance	$V_{DS} = -10\text{ V}, I_D = -1.5\text{ A}$		12		S
<b>Dynamic Characteristics</b>						
$C_{ISS}$	Input Capacitance	$V_{GS} = 0\text{ V}, V_{DS} = -10\text{ V}, f = 1\text{ MHz}$		475	570	pF
$C_{OSS}$	Output Capacitance			234	281	pF
$C_{RSS}$	Reverse Transfer Capacitance			10.5	13.1	pF
$Q_g$	Gate Charge Total (-4.5 V)	$V_{DS} = -10\text{ V}, I_D = -1.5\text{ A}$		3.4	4.1	nC
$Q_{gd}$	Gate Charge Gate to Drain			0.2		nC
$Q_{gs}$	Gate Charge Gate to Source			1.1		nC
$Q_{g(th)}$	Gate Charge at $V_{th}$			0.6		nC
$Q_{OSS}$	Output Charge	$V_{DS} = -10\text{ V}, V_{GS} = 0\text{ V}$		3.8		nC
$t_{d(on)}$	Turn On Delay Time	$V_{DS} = -10\text{ V}, V_{GS} = -4.5\text{ V}, I_D = -1.5\text{ A}$ $R_G = 4\ \Omega$		13.6		ns
$t_r$	Rise Time			8.8		ns
$t_{d(off)}$	Turn Off Delay Time			36.9		ns
$t_f$	Fall Time			14.2		ns
<b>Diode Characteristics</b>						
$V_{SD}$	Diode Forward Voltage	$I_S = -1.5\text{ A}, V_{GS} = 0\text{ V}$		-0.8	-1	V
$Q_{rr}$	Reverse Recovery Charge	$V_{dd} = -10\text{ V}, I_F = -1.5\text{ A}, di/dt = 200\text{ A}/\mu\text{s}$		6.9		nC
$t_{rr}$	Reverse Recovery Time			11.6		ns

## 6 Thermal Characteristics

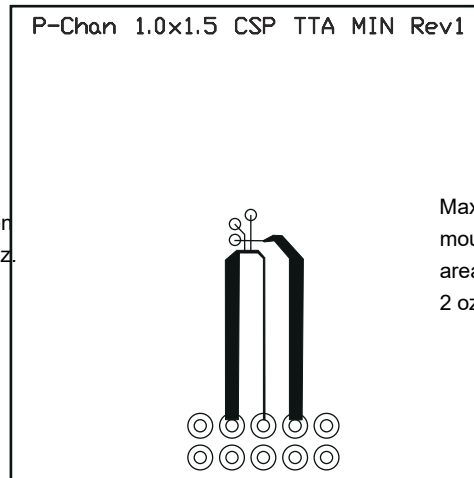
( $T_A = 25^\circ\text{C}$  unless otherwise stated)

PARAMETER		MIN	TYP	MAX	UNIT
$R_{\theta JA}$	Thermal Resistance Junction to Ambient (Minimum Cu area)			230	$^\circ\text{C/W}$
	Thermal Resistance Junction to Ambient (1 in <sup>2</sup> Cu area)			149	$^\circ\text{C/W}$



Max  $R_{\theta JA} = 149^\circ\text{C/W}$  when mounted on 1 inch<sup>2</sup> of 2 oz. Cu.

M0155-01

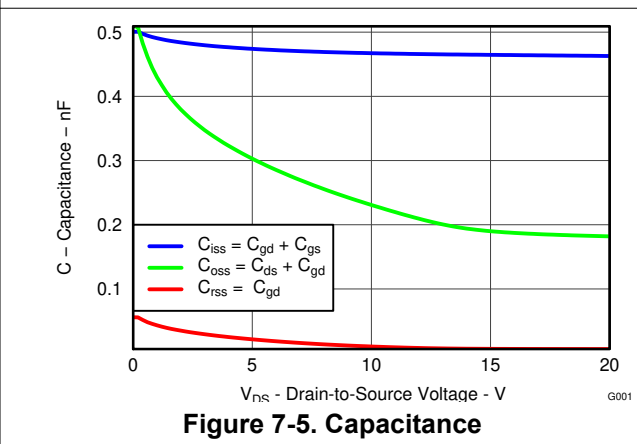
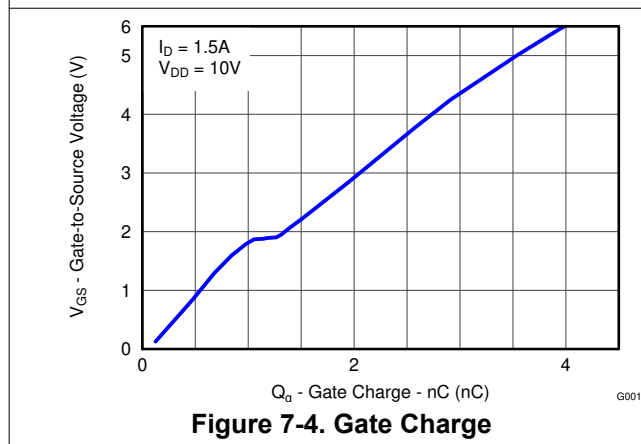
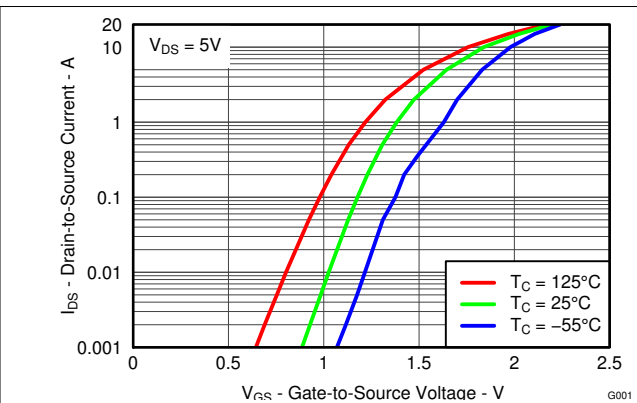
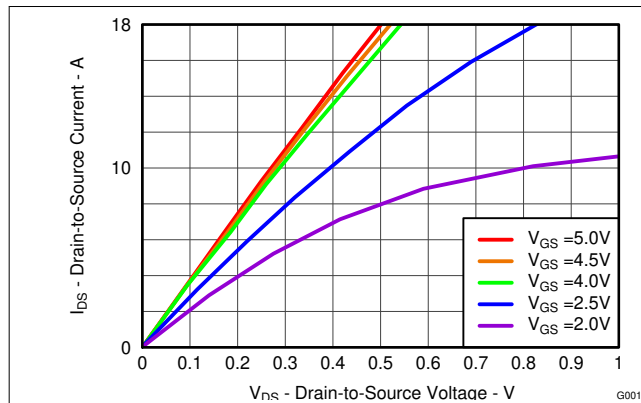
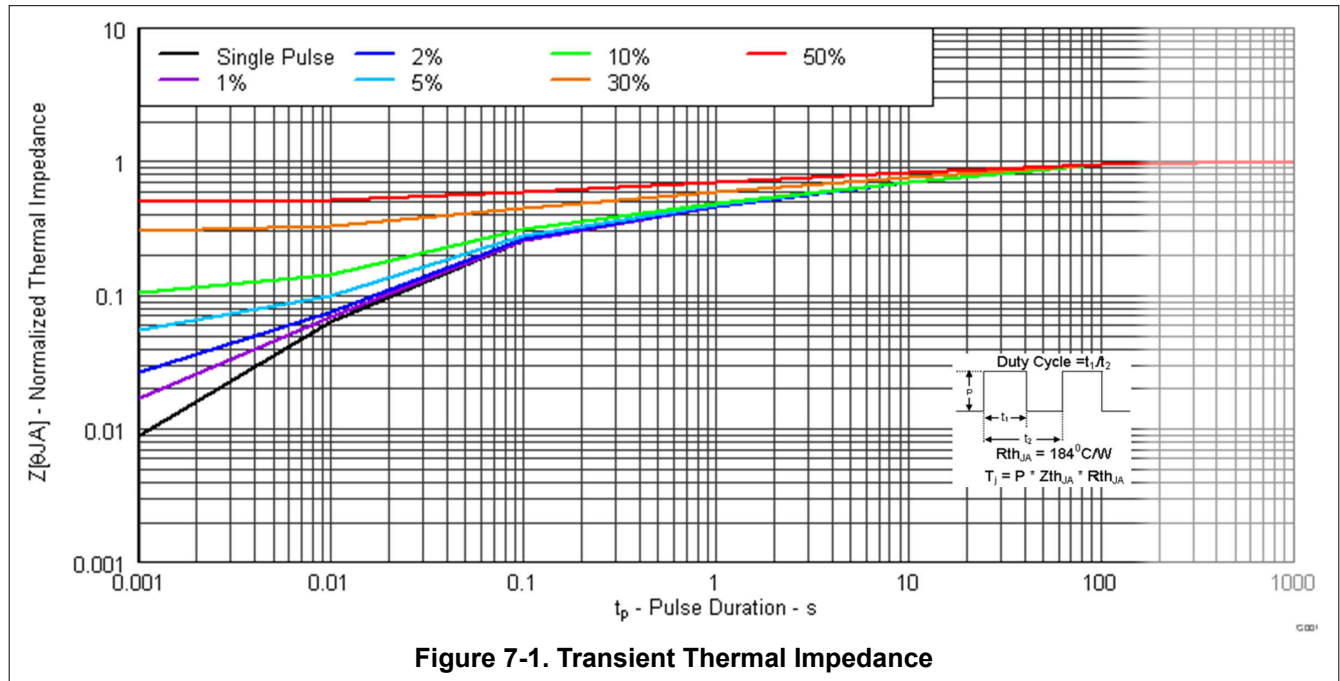


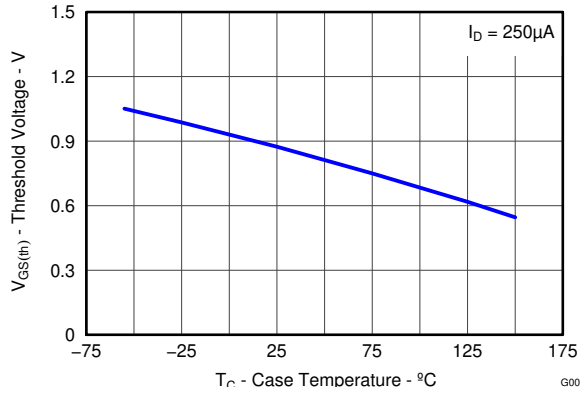
Max  $R_{\theta JA} = 230^\circ\text{C/W}$  when mounted on minimum pad area of 2 oz. Cu.

M0156-01

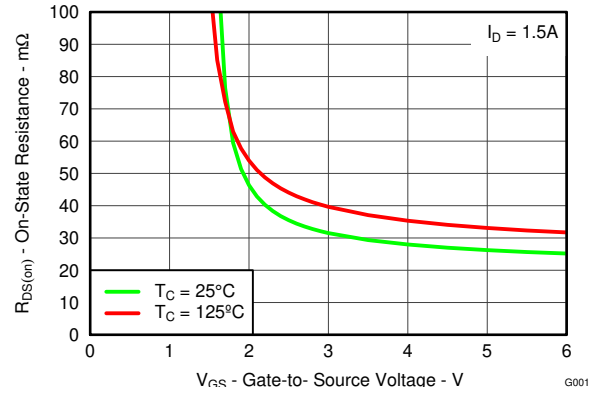
## 7 Typical MOSFET Characteristics

( $T_A = 25^\circ\text{C}$  unless otherwise stated)

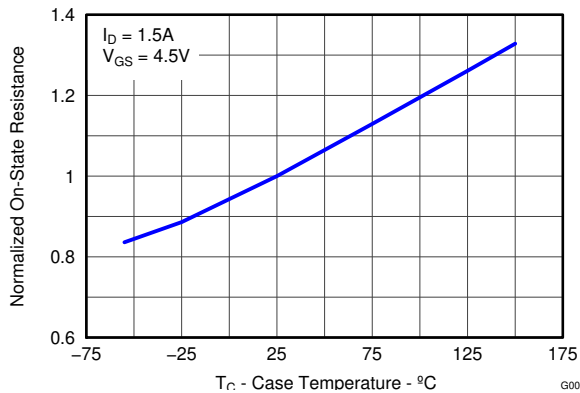




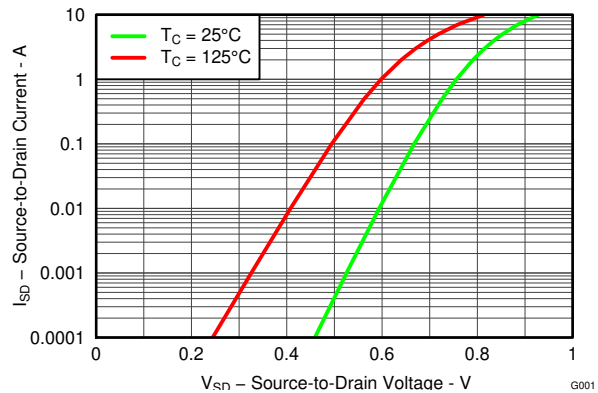
**Figure 7-6. Threshold Voltage vs Temperature**



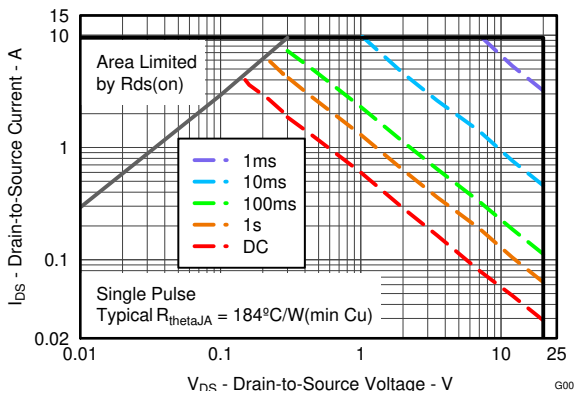
**Figure 7-7. On Resistance vs Gate Voltage**



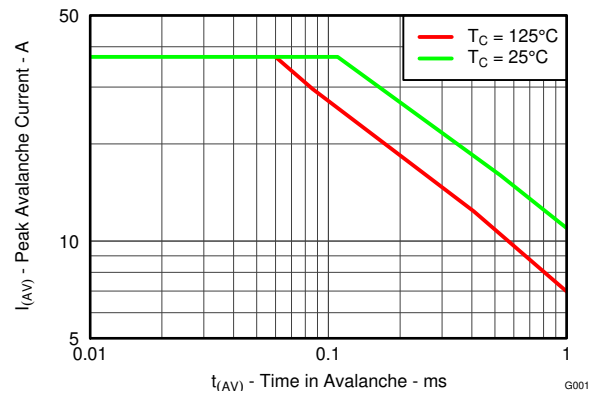
**Figure 7-8. Normalized On Resistance vs Temperature**



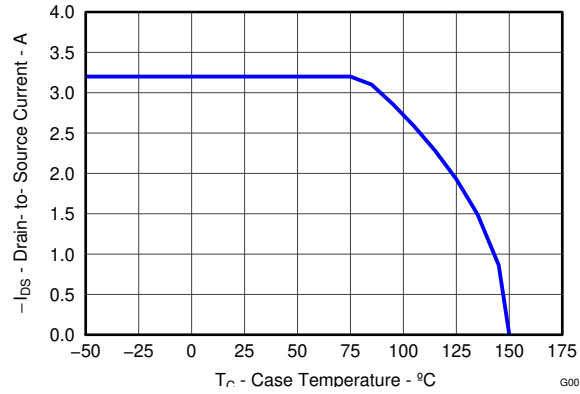
**Figure 7-9. Typical Diode Forward Voltage**



**Figure 7-10. Maximum Safe Operating Area**



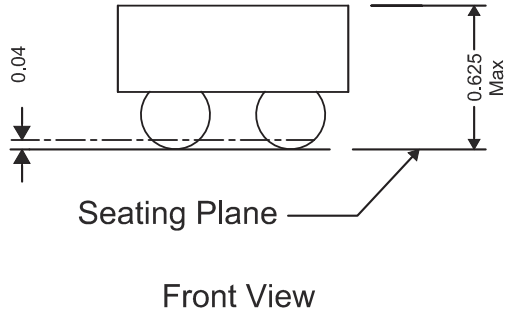
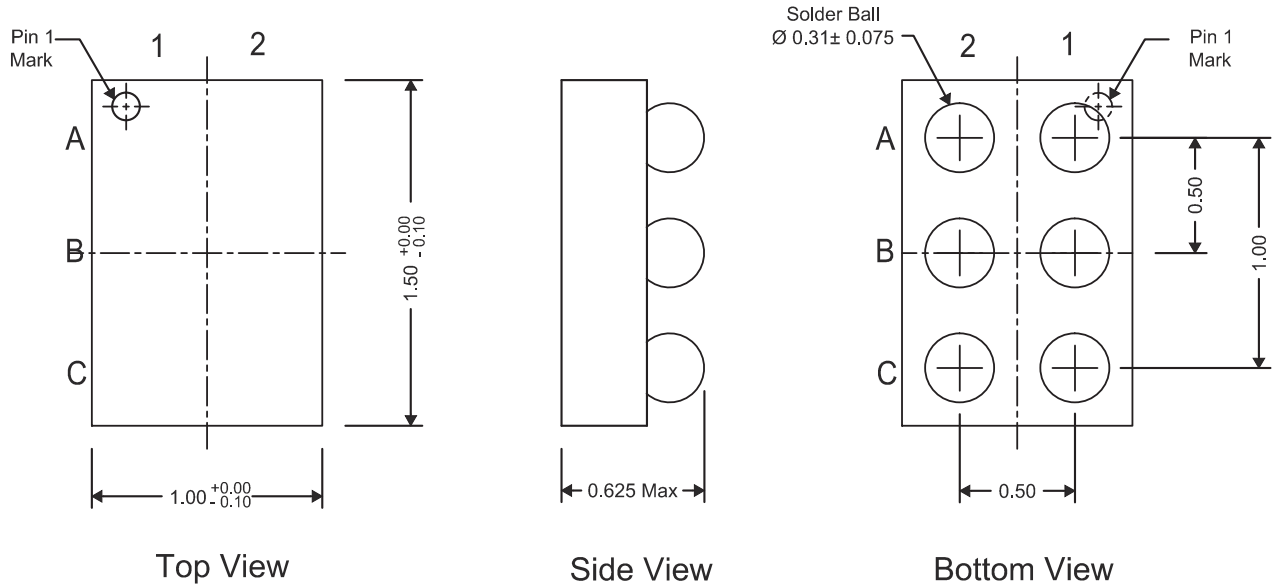
**Figure 7-11. Single Pulse Unclamped Inductive Switching**



**Figure 7-12. Maximum Drain Current vs Temperature**

## 8 Mechanical Data

### 8.1 CSD25211W1015 Package Dimensions



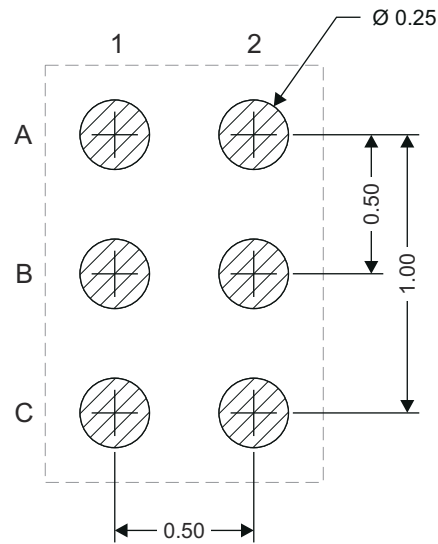
All dimensions are in mm (unless otherwise specified)

#### Pinout

POSITION	DESIGNATION
C1, C2	Drain
A1	Gate
A2, B1, B2	Source



## 8.2 Land Pattern Recommendation



M0158-01

All dimensions are in mm (unless otherwise specified)

## 9 Electrostatic Discharge Caution



This integrated circuit can be damaged by ESD. Texas Instruments recommends that all integrated circuits be handled with appropriate precautions. Failure to observe proper handling and installation procedures can cause damage.

ESD damage can range from subtle performance degradation to complete device failure. Precision integrated circuits may be more susceptible to damage because very small parametric changes could cause the device not to meet its published specifications.

## 10 Device and Documentation Support

### 10.1 Third-Party Products Disclaimer

TI'S PUBLICATION OF INFORMATION REGARDING THIRD-PARTY PRODUCTS OR SERVICES DOES NOT CONSTITUTE AN ENDORSEMENT REGARDING THE SUITABILITY OF SUCH PRODUCTS OR SERVICES OR A WARRANTY, REPRESENTATION OR ENDORSEMENT OF SUCH PRODUCTS OR SERVICES, EITHER ALONE OR IN COMBINATION WITH ANY TI PRODUCT OR SERVICE.

### 10.2 Receiving Notification of Documentation Updates

To receive notification of documentation updates, navigate to the device product folder on [ti.com](http://ti.com). Click on *Subscribe to updates* to register and receive a weekly digest of any product information that has changed. For change details, review the revision history included in any revised document.

### 10.3 Support Resources

[TI E2E™ support forums](#) are an engineer's go-to source for fast, verified answers and design help — straight from the experts. Search existing answers or ask your own question to get the quick design help you need.

Linked content is provided "AS IS" by the respective contributors. They do not constitute TI specifications and do not necessarily reflect TI's views; see TI's [Terms of Use](#).

### 10.4 Trademarks

NexFET™ is a trademark of TI.

TI E2E™ is a trademark of Texas Instruments.

All trademarks are the property of their respective owners.

### 10.5 Electrostatic Discharge Caution



This integrated circuit can be damaged by ESD. Texas Instruments recommends that all integrated circuits be handled with appropriate precautions. Failure to observe proper handling and installation procedures can cause damage.

ESD damage can range from subtle performance degradation to complete device failure. Precision integrated circuits may be more susceptible to damage because very small parametric changes could cause the device not to meet its published specifications.

### 10.6 Glossary

[TI Glossary](#) This glossary lists and explains terms, acronyms, and definitions.

**PACKAGING INFORMATION**

Orderable part number	Status (1)	Material type (2)	Package   Pins	Package qty   Carrier	RoHS (3)	Lead finish/ Ball material (4)	MSL rating/ Peak reflow (5)	Op temp (°C)	Part marking (6)
<a href="#">CSD25211W1015</a>	Active	Production	DSBGA (YZC)   6	3000   LARGE T&R	Yes	SNAGCU	Level-1-260C-UNLIM	-55 to 150	25211
CSD25211W1015.B	Active	Production	DSBGA (YZC)   6	3000   LARGE T&R	Yes	SNAGCU	Level-1-260C-UNLIM	-55 to 150	25211

(1) **Status:** For more details on status, see our [product life cycle](#).

(2) **Material type:** When designated, preproduction parts are prototypes/experimental devices, and are not yet approved or released for full production. Testing and final process, including without limitation quality assurance, reliability performance testing, and/or process qualification, may not yet be complete, and this item is subject to further changes or possible discontinuation. If available for ordering, purchases will be subject to an additional waiver at checkout, and are intended for early internal evaluation purposes only. These items are sold without warranties of any kind.

(3) **RoHS values:** Yes, No, RoHS Exempt. See the [TI RoHS Statement](#) for additional information and value definition.

(4) **Lead finish/Ball material:** Parts may have multiple material finish options. Finish options are separated by a vertical ruled line. Lead finish/Ball material values may wrap to two lines if the finish value exceeds the maximum column width.

(5) **MSL rating/Peak reflow:** The moisture sensitivity level ratings and peak solder (reflow) temperatures. In the event that a part has multiple moisture sensitivity ratings, only the lowest level per JEDEC standards is shown. Refer to the shipping label for the actual reflow temperature that will be used to mount the part to the printed circuit board.

(6) **Part marking:** There may be an additional marking, which relates to the logo, the lot trace code information, or the environmental category of the part.

Multiple part markings will be inside parentheses. Only one part marking contained in parentheses and separated by a "~" will appear on a part. If a line is indented then it is a continuation of the previous line and the two combined represent the entire part marking for that device.

**Important Information and Disclaimer:**The information provided on this page represents TI's knowledge and belief as of the date that it is provided. TI bases its knowledge and belief on information provided by third parties, and makes no representation or warranty as to the accuracy of such information. Efforts are underway to better integrate information from third parties. TI has taken and continues to take reasonable steps to provide representative and accurate information but may not have conducted destructive testing or chemical analysis on incoming materials and chemicals. TI and TI suppliers consider certain information to be proprietary, and thus CAS numbers and other limited information may not be available for release.

In no event shall TI's liability arising out of such information exceed the total purchase price of the TI part(s) at issue in this document sold by TI to Customer on an annual basis.

**TAPE AND REEL INFORMATION**

**QUADRANT ASSIGNMENTS FOR PIN 1 ORIENTATION IN TAPE**


\*All dimensions are nominal

Device	Package Type	Package Drawing	Pins	SPQ	Reel Diameter (mm)	Reel Width W1 (mm)	A0 (mm)	B0 (mm)	K0 (mm)	P1 (mm)	W (mm)	Pin1 Quadrant
CSD25211W1015	DSBGA	YZC	6	3000	180.0	8.4	1.09	1.56	0.65	2.0	8.0	Q1

**TAPE AND REEL BOX DIMENSIONS**


\*All dimensions are nominal

Device	Package Type	Package Drawing	Pins	SPQ	Length (mm)	Width (mm)	Height (mm)
CSD25211W1015	DSBGA	YZC	6	3000	182.0	182.0	20.0

## IMPORTANT NOTICE AND DISCLAIMER

TI PROVIDES TECHNICAL AND RELIABILITY DATA (INCLUDING DATASHEETS), DESIGN RESOURCES (INCLUDING REFERENCE DESIGNS), APPLICATION OR OTHER DESIGN ADVICE, WEB TOOLS, SAFETY INFORMATION, AND OTHER RESOURCES "AS IS" AND WITH ALL FAULTS, AND DISCLAIMS ALL WARRANTIES, EXPRESS AND IMPLIED, INCLUDING WITHOUT LIMITATION ANY IMPLIED WARRANTIES OF MERCHANTABILITY, FITNESS FOR A PARTICULAR PURPOSE OR NON-INFRINGEMENT OF THIRD PARTY INTELLECTUAL PROPERTY RIGHTS.

These resources are intended for skilled developers designing with TI products. You are solely responsible for (1) selecting the appropriate TI products for your application, (2) designing, validating and testing your application, and (3) ensuring your application meets applicable standards, and any other safety, security, regulatory or other requirements.

These resources are subject to change without notice. TI grants you permission to use these resources only for development of an application that uses the TI products described in the resource. Other reproduction and display of these resources is prohibited. No license is granted to any other TI intellectual property right or to any third party intellectual property right. TI disclaims responsibility for, and you fully indemnify TI and its representatives against any claims, damages, costs, losses, and liabilities arising out of your use of these resources.

TI's products are provided subject to [TI's Terms of Sale](#), [TI's General Quality Guidelines](#), or other applicable terms available either on [ti.com](#) or provided in conjunction with such TI products. TI's provision of these resources does not expand or otherwise alter TI's applicable warranties or warranty disclaimers for TI products. Unless TI explicitly designates a product as custom or customer-specified, TI products are standard, catalog, general purpose devices.

TI objects to and rejects any additional or different terms you may propose.

Copyright © 2025, Texas Instruments Incorporated

Last updated 10/2025