

INA821 35- μV Offset, 7-nV/ $\sqrt{\text{Hz}}$ Noise, Low-Power, Precision Instrumentation Amplifier

1 Features

- Low offset voltage: 10 μV (typ), 35 μV (max)
- Gain drift: 5 ppm/ $^{\circ}\text{C}$ ($G = 1$), 35 ppm/ $^{\circ}\text{C}$ ($G > 1$) (max)
- Noise: 7 nV/ $\sqrt{\text{Hz}}$
- Bandwidth: 4.7 MHz ($G = 1$), 290 kHz ($G = 100$)
- Stable with 1-nF capacitive loads
- Inputs protected up to $\pm 40\text{ V}$
- Common-mode rejection: 112 dB, $G = 10$ (min)
- Power supply rejection: 110 dB, $G = 1$ (min)
- Supply current: 650 μA (max)
- Supply range:
 - Single-supply: 4.5 V to 36 V
 - Dual-supply: $\pm 2.25\text{ V}$ to $\pm 18\text{ V}$
- Specified temperature range: -40°C to $+125^{\circ}\text{C}$
- Packages: 8-pin SOIC, VSSOP, and WSON

2 Applications

- [Analog input module](#)
- [Flow transmitter](#)
- [Battery test](#)
- [LCD test](#)
- [Electrocardiogram \(ECG\)](#)
- [Surgical equipment](#)
- [Process analytics \(pH, gas, concentration, force and humidity\)](#)

INA821 Simplified Internal Schematic

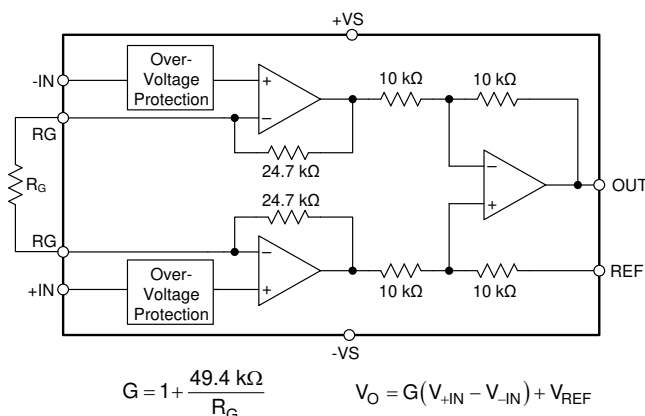

3 Description

The INA821 is a high-precision instrumentation amplifier that offers low power consumption and operates over a wide single-supply or dual-supply range. A single external resistor sets any gain from 1 to 10,000. The device has high precision as a result of super-beta input transistors, which provide low input offset voltage, offset voltage drift, input bias current, and input voltage and current noise. Additional circuitry protects the inputs against overvoltage up to $\pm 40\text{ V}$.

The INA821 is optimized to provide a high common-mode rejection ratio. At $G = 1$, the common-mode rejection ratio exceeds 92 dB across the full input common-mode range. The device is designed for low-voltage operation from a 4.5-V single supply, and dual supplies up to $\pm 18\text{ V}$.

The INA821 is available in 8-pin SOIC, VSSOP, and WSON packages, and is specified over the -40°C to $+125^{\circ}\text{C}$ temperature range.

Device Information⁽¹⁾

PART NUMBER	PACKAGE	BODY SIZE (NOM)
INA821	SOIC (8)	4.90 mm x 3.91 mm
	VSSOP (8)	3.00 mm x 3.00 mm
	WSON (8)	3.00 mm x 3.00 mm

(1) For all available packages, see the package option addendum at the end of the data sheet.

Typical Distribution of Input Stage Offset Voltage Drift

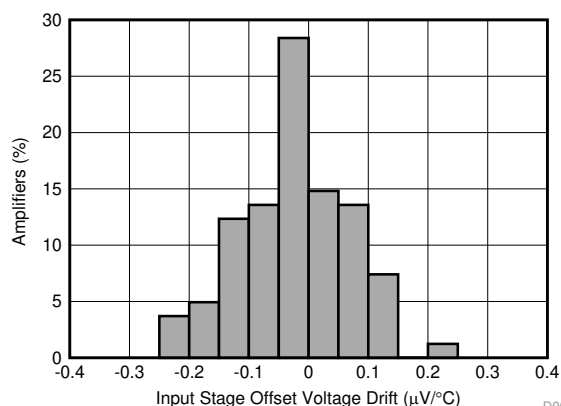

D002



Table of Contents

1 Features	1	8.4 Device Functional Modes.....	26
2 Applications	1	9 Application and Implementation	26
3 Description	1	9.1 Application Information.....	26
4 Revision History	2	9.2 Typical Application	29
5 Device Comparison Table	3	9.3 Other Application Examples.....	31
6 Pin Configuration and Functions	4	10 Power Supply Recommendations	32
7 Specifications	5	11 Layout	32
7.1 Absolute Maximum Ratings	5	11.1 Layout Guidelines	32
7.2 ESD Ratings	5	11.2 Layout Example	33
7.3 Recommended Operating Conditions.....	5	12 Device and Documentation Support	34
7.4 Thermal Information	5	12.1 Device Support	34
7.5 Electrical Characteristics.....	6	12.2 Documentation Support	34
7.6 Typical Characteristics: Table of Graphs.....	8	12.3 Receiving Notification of Documentation Updates	34
7.7 Typical Characteristics	10	12.4 Support Resources	34
8 Detailed Description	19	12.5 Trademarks	34
8.1 Overview	19	12.6 Electrostatic Discharge Caution.....	34
8.2 Functional Block Diagram	19	12.7 Glossary	34
8.3 Feature Description.....	20	13 Mechanical, Packaging, and Orderable Information	34

4 Revision History

NOTE: Page numbers for previous revisions may differ from page numbers in the current version.

Changes from Revision C (July 2019) to Revision D	Page
• Added DRG (WSON) package and associated content to data sheet	1
Changes from Revision B (May 2019) to Revision C	Page
• Changed DGK (VSSOP) package from advanced information (preview) to production data (active)	1
• Changed Figure 9, <i>Typical Distribution of Input Offset Current</i> , to show correct image	11
• Changed Figure 27, <i>Typical Distribution of Gain Error, G = 1</i> , to show improved data	14
Changes from Revision A (December 2018) to Revision B	Page
• Added 8-pin DGK (VSSOP) advanced information package and associated content to data sheet	1
• Changed <i>Applications</i> bullets	1
Changes from Original (August 2018) to Revision A	Page
• First release of production-data data sheet	1

5 Device Comparison Table

DEVICE	DESCRIPTION	GAIN EQUATION	RG PINS AT PIN
INA821	35- μ V Offset, 0.4 μ V/ $^{\circ}$ C V_{OS} Drift, 7-nV/ $\sqrt{\text{Hz}}$ Noise, High-Bandwidth, Precision Instrumentation Amplifier	$G = 1 + 49.4 \text{ k}\Omega / \text{RG}$	2, 3
INA819	35- μ V Offset, 0.4 μ V/ $^{\circ}$ C V_{OS} Drift, 8-nV/ $\sqrt{\text{Hz}}$ Noise, Low-Power, Precision Instrumentation Amplifier	$G = 1 + 50 \text{ k}\Omega / \text{RG}$	2, 3
INA818	35- μ V Offset, 0.4 μ V/ $^{\circ}$ C V_{OS} Drift, 8-nV/ $\sqrt{\text{Hz}}$ Noise, Low-Power, Precision Instrumentation Amplifier	$G = 1 + 50 \text{ k}\Omega / \text{RG}$	1, 8
INA828	50- μ V Offset, 0.5 μ V/ $^{\circ}$ C V_{OS} Drift, 7-nV/ $\sqrt{\text{Hz}}$ Noise, Low-Power, Precision Instrumentation Amplifier	$G = 1 + 50 \text{ k}\Omega / \text{RG}$	1, 8
INA333	25- μ V V_{OS} , 0.1 μ V/ $^{\circ}$ C V_{OS} Drift, 1.8-V to 5-V, RRO, 50- μ A I_Q , Chopper-Stabilized INA	$G = 1 + 100 \text{ k}\Omega / \text{RG}$	1, 8
PGA280	20-mV to \pm 10-V Programmable Gain IA With 3-V or 5-V Differential Output; Analog Supply up to \pm 18 V	Digital programmable	N/A
INA159	$G = 0.2 \text{ V}$ Differential Amplifier for \pm 10-V to 3-V and 5-V Conversion	$G = 0.2 \text{ V/V}$	N/A
PGA112	Precision Programmable Gain Op Amp With SPI	Digital programmable	N/A

6 Pin Configuration and Functions

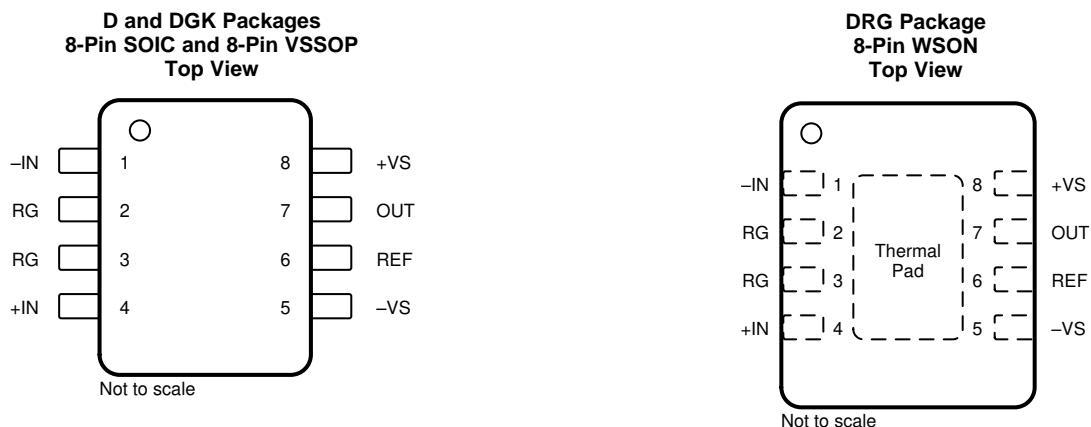

Pin Functions

PIN		I/O	DESCRIPTION
NAME	NO.		
-IN	1	I	Negative (inverting) input
+IN	4	O	Positive (noninverting) input
OUT	7	—	Output
RG	2, 3	I	Gain setting pin. Place a gain resistor between pin 2 and pin 3.
REF	6	—	Reference input. This pin must be driven by a low impedance source.
-VS	5	—	Negative supply
+VS	8	—	Positive supply
Thermal pad	—	—	Thermal pad internally connected to -VS. Connect externally to -VS or leave floating.

7 Specifications

7.1 Absolute Maximum Ratings

over operating free-air temperature range (unless otherwise noted)⁽¹⁾

		MIN	MAX	UNIT
Supply voltage		-20	20	V
Signal input pins	Voltage	-40	40	V
	REF pin	-20	20	
Signal output pins		$(-V_S) - 0.5$	$(+V_S) + 0.5$	V
Output short-circuit ⁽²⁾		Continuous		
Operating Temperature, T_A		-50	150	°C
Junction Temperature, T_J			175	
Storage Temperature, T_{stg}		-65	150	

(1) Stresses beyond those listed under *Absolute Maximum Ratings* may cause permanent damage to the device. These are stress ratings only, which do not imply functional operation of the device at these or any other conditions beyond those indicated under *Recommended Operating Conditions*. Exposure to absolute-maximum-rated conditions for extended periods may affect device reliability.

(2) Short-circuit to $V_S / 2$.

7.2 ESD Ratings

			VALUE	UNIT
$V_{(ESD)}$	Electrostatic discharge	Human-body model (HBM), per ANSI/ESDA/JEDEC JS-001 ⁽¹⁾	±1500	V
		Charged-device model (CDM), per JEDEC specification JESD22-C101 ⁽²⁾	±750	

(1) JEDEC document JEP155 states that 500-V HBM allows safe manufacturing with a standard ESD control process.

(2) JEDEC document JEP157 states that 250-V CDM allows safe manufacturing with a standard ESD control process.

7.3 Recommended Operating Conditions

over operating free-air temperature range (unless otherwise noted)

		MIN	MAX	UNIT
Supply voltage, V_S	Single-supply	4.5	36	V
	Dual-supply	±2.25	±18	
Specified temperature, T_A		-40	125	°C

7.4 Thermal Information

THERMAL METRIC ⁽¹⁾		INA821			UNIT
		D (SOIC)	DGK (VSSOP)	DRG (WSON)	
		8 PINS	8 PINS	8 PINS	
$R_{\theta JA}$	Junction-to-ambient thermal resistance	119.6	215.4	55.6	°C/W
$R_{\theta JC(top)}$	Junction-to-case (top) thermal resistance	66.3	66.3	57.9	°C/W
$R_{\theta JB}$	Junction-to-board thermal resistance	61.9	97.8	28.6	°C/W
Ψ_{JT}	Junction-to-top characterization parameter	20.5	10.5	1.8	°C/W
Ψ_{JB}	Junction-to-board characterization parameter	61.4	96.1	28.6	°C/W
$R_{\theta JC(bot)}$	Junction-to-case (bottom) thermal resistance	N/A	N/A	12.1	°C/W

(1) For more information about traditional and new thermal metrics, see the [Semiconductor and IC Package Thermal Metrics](#) application report.

7.5 Electrical Characteristics

 at $T_A = 25^\circ\text{C}$, $V_S = \pm 15\text{ V}$, $R_L = 10\text{ k}\Omega$, $V_{\text{REF}} = 0\text{ V}$, and $G = 1$ (unless otherwise noted)

PARAMETER		TEST CONDITIONS	MIN	TYP	MAX	UNIT	
INPUT							
V_{OSI}	Input stage offset voltage ⁽¹⁾⁽²⁾	INA821ID, INA821DRG		10	35	μV	
		INA821IDGK		10	40		
		$T_A = -40^\circ\text{C}$ to $+125^\circ\text{C}$ ⁽³⁾	INA821ID, INA821DRG			75	μV
			INA821IDGK			80	
vs temperature, $T_A = -40^\circ\text{C}$ to $+125^\circ\text{C}$				0.1	0.4	$\mu\text{V}/^\circ\text{C}$	
V_{OSO}	Output stage offset voltage ⁽¹⁾⁽²⁾	INA821ID, INA821DGGK		50	350	μV	
		INA821DRG		50	400		
		$T_A = -40^\circ\text{C}$ to $+125^\circ\text{C}$ ⁽³⁾				850	$\mu\text{V}/^\circ\text{C}$
vs temperature, $T_A = -40^\circ\text{C}$ to $+125^\circ\text{C}$					5		
PSRR	Power-supply rejection ratio	$G = 1$, RTI	110	120		dB	
		$G = 10$, RTI	114	130			
		$G = 100$, RTI	130	135			
		$G = 1000$, RTI	136	140			
Z_{id}	Differential impedance			100 1		$\text{G}\Omega$ pF	
Z_{ic}	Common-mode impedance			100 7		$\text{G}\Omega$ pF	
	RFI filter, -3-dB frequency			45		MHz	
V_{CM}	Operating input range ⁽⁴⁾	$V_S = \pm 2.25\text{ V}$ to $\pm 18\text{ V}$, $T_A = -40^\circ\text{C}$ to $+125^\circ\text{C}$	$(V-) + 2$	$(V+) - 2$		V	
	Input overvoltage range	$T_A = -40^\circ\text{C}$ to $+125^\circ\text{C}$ ⁽³⁾	See Figure 51 to Figure 54		± 40		
CMRR	Common-mode rejection ratio	At DC to 60 Hz, RTI, $V_{\text{CM}} = (V-) + 2\text{ V}$ to $(V+) - 2\text{ V}$, $G = 1$	92	105		dB	
		At DC to 60 Hz, RTI, $V_{\text{CM}} = (V-) + 2\text{ V}$ to $(V+) - 2\text{ V}$, $G = 10$	112	125			
		At DC to 60 Hz, RTI, $V_{\text{CM}} = (V-) + 2\text{ V}$ to $(V+) - 2\text{ V}$, $G = 100$	132	145			
		At DC to 60 Hz, RTI, $V_{\text{CM}} = (V-) + 2\text{ V}$ to $(V+) - 2\text{ V}$, $G = 1000$	140	150			
BIAS CURRENT							
I_{B}	Input bias current	$V_{\text{CM}} = V_S / 2$		0.15	0.5	nA	
		$T_A = -40^\circ\text{C}$ to $+125^\circ\text{C}$			2		
I_{OS}	Input offset current	$V_{\text{CM}} = V_S / 2$		0.15	0.5	nA	
		$T_A = -40^\circ\text{C}$ to $+125^\circ\text{C}$			2		
NOISE VOLTAGE							
e_{NI}	Input stage voltage noise ⁽⁵⁾	$f = 1\text{ kHz}$, $G = 100$, $R_S = 0\ \Omega$		7		$\text{nV}/\sqrt{\text{Hz}}$	
		$f_{\text{B}} = 0.1\text{ Hz}$ to 10 Hz , $G = 100$, $R_S = 0\ \Omega$			0.14	μV_{PP}	
e_{NO}	Output stage voltage noise ⁽⁵⁾	$f = 1\text{ kHz}$, $R_S = 0\ \Omega$		65		$\text{nV}/\sqrt{\text{Hz}}$	
		$f_{\text{B}} = 0.1\text{ Hz}$ to 10 Hz , $R_S = 0\ \Omega$			2.5	μV_{PP}	
I_{n}	Noise current	$f = 1\text{ kHz}$		130		$\text{fA}/\sqrt{\text{Hz}}$	
		$f_{\text{B}} = 0.1\text{ Hz}$ to 10 Hz , $G = 100$			4.7	pA_{PP}	
GAIN							
G	Gain equation		$1 + (49.4\text{ k}\Omega / R_G)$			V/V	
	Range of gain		1		10000	V/V	

 (1) Total offset, referred-to-input (RTI): $V_{\text{OS}} = (V_{\text{OSI}}) + (V_{\text{OSO}} / G)$.

 (2) Offset drifts are uncorrelated. Input-referred offset drift is calculated using: $\Delta V_{\text{OS(RTI)}} = \sqrt{[\Delta V_{\text{OSI}}]^2 + (\Delta V_{\text{OSO}} / G)^2}$.

(3) Specified by characterization.

 (4) Input voltage range of the Instrumentation Amplifier input stage. The input range depends on the common-mode voltage, differential voltage, gain, and reference voltage. See *Typical Characteristic* curves [Figure 51](#) through [Figure 54](#) for more information.

 (5) Total RTI voltage noise is equal to: $e_{\text{N(RTI)}} = \sqrt{[e_{\text{NI}}]^2 + (e_{\text{NO}} / G)^2}$.

Electrical Characteristics (continued)

at $T_A = 25^\circ\text{C}$, $V_S = \pm 15\text{ V}$, $R_L = 10\text{ k}\Omega$, $V_{REF} = 0\text{ V}$, and $G = 1$ (unless otherwise noted)

PARAMETER		TEST CONDITIONS	MIN	TYP	MAX	UNIT
GE	Gain error	$G = 1, V_O = \pm 10\text{ V}$		$\pm 0.005\%$	$\pm 0.025\%$	
		$G = 10, V_O = \pm 10\text{ V}$		$\pm 0.025\%$	$\pm 0.15\%$	
		$G = 100, V_O = \pm 10\text{ V}$		$\pm 0.025\%$	$\pm 0.15\%$	
		$G = 1000, V_O = \pm 10\text{ V}$		$\pm 0.05\%$		
	Gain vs temperature ⁽⁶⁾	$G = 1, T_A = -40^\circ\text{C to } +125^\circ\text{C}$			± 5	ppm/ $^\circ\text{C}$
		$G > 1, T_A = -40^\circ\text{C to } +125^\circ\text{C}$			± 35	
	Gain nonlinearity	$G = 1\text{ to } 10, V_O = -10\text{ V to } 10\text{ V}, R_L = 10\text{ k}\Omega$		1	10	ppm
		$G = 100, V_O = -10\text{ V to } 10\text{ V}, R_L = 10\text{ k}\Omega$			15	
		$G = 1000, V_O = -10\text{ V to } 10\text{ V}, R_L = 10\text{ k}\Omega$		10		
		$G = 1\text{ to } 100, V_O = -10\text{ V to } 10\text{ V}, R_L = 2\text{ k}\Omega$		30		
OUTPUT						
	Voltage swing		$(V-) + 0.15$		$(V+) - 0.15$	V
	Load capacitance stability			1000		pF
Z_O	Closed-loop output impedance	$f = 10\text{ kHz}$		1.3		Ω
I_{SC}	Short-circuit current	Continuous to $V_S / 2$		± 20		mA
FREQUENCY RESPONSE						
BW	Bandwidth, -3 dB	$G = 1$		4.7		MHz
		$G = 10$		970		kHz
		$G = 100$		290		
		$G = 1000$		30		
SR	Slew rate	$G = 1, V_O = \pm 10\text{ V}$		2.0		V/ μs
t_S	Settling time	0.01%, $G = 1\text{ to } 100, V_{STEP} = 10\text{ V}$		6		μs
		0.01%, $G = 1000, V_{STEP} = 10\text{ V}$		40		
		0.001%, $G = 1\text{ to } 100, V_{STEP} = 10\text{ V}$		10		
		0.001%, $G = 1000, V_{STEP} = 10\text{ V}$		50		
REFERENCE INPUT						
R_{IN}	Input impedance			10		k Ω
	Voltage range		$(V-)$		$(V+)$	V
	Gain to output			1		V/V
	Reference gain error			0.01%		
POWER SUPPLY						
V_S	Power-supply voltage	Single-supply	4.5		36	V
		Dual-supply	± 2.25		± 18	
I_Q	Quiescent current	$V_{IN} = 0\text{ V}$		600	650	μA
		vs temperature, $T_A = -40^\circ\text{C to } +125^\circ\text{C}$				

(6) The values specified for $G > 1$ do not include the effects of the external gain-setting resistor, R_G .

7.6 Typical Characteristics: Table of Graphs

at $T_A = 25^\circ\text{C}$, $V_S = \pm 15\text{ V}$, $R_L = 10\text{ k}\Omega$, $V_{\text{REF}} = 0\text{ V}$, and $G = 1$ (unless otherwise noted)

Table 1. Table of Graphs

DESCRIPTION	FIGURE
Typical Distribution of Input Stage Offset Voltage	Figure 1
Typical Distribution of Input Stage Offset Voltage Drift	Figure 2
Typical Distribution of Output Stage Offset Voltage	Figure 3
Typical Distribution of Output Stage Offset Voltage Drift	Figure 4
Input Stage Offset Voltage vs Temperature	Figure 5
Output Stage Offset Voltage vs Temperature	Figure 6
Typical Distribution of Input Bias Current, $T_A = 25^\circ\text{C}$	Figure 7
Typical Distribution of Input Bias Current, $T_A = 90^\circ\text{C}$	Figure 8
Typical Distribution of Input Offset Current	Figure 9
Input Bias Current vs Temperature	Figure 10
Input Offset Current vs Temperature	Figure 11
Typical CMRR Distribution, $G = 1$	Figure 12
Typical CMRR Distribution, $G = 10$	Figure 13
CMRR vs Temperature, $G = 1$	Figure 14
CMRR vs Temperature, $G = 10$	Figure 15
Input Current vs Input Overvoltage	Figure 16
CMRR vs Frequency (RTI)	Figure 17
CMRR vs Frequency (RTI, 1-k Ω source imbalance)	Figure 18
Positive PSRR vs Frequency (RTI)	Figure 19
Negative PSRR vs Frequency (RTI)	Figure 20
Gain vs Frequency	Figure 21
Voltage Noise Spectral Density vs Frequency (RTI)	Figure 22
Current Noise Spectral Density vs Frequency (RTI)	Figure 23
0.1-Hz to 10-Hz RTI Voltage Noise, $G = 1$	Figure 24
0.1-Hz to 10-Hz RTI Voltage Noise, $G = 1000$	Figure 25
0.1-Hz to 10-Hz RTI Current Noise	Figure 26
Typical Distribution of Gain Error, $G = 1$	Figure 27
Typical Distribution of Gain Error, $G = 10$	Figure 28
Input Bias Current vs Common-Mode Voltage	Figure 29
Gain Error vs Temperature, $G = 1$	Figure 30
Gain Error vs Temperature, $G = 10$	Figure 31
Supply Current vs Temperature	Figure 32
Gain Nonlinearity, $G = 1$	Figure 33
Gain Nonlinearity, $G = 10$	Figure 34
Offset Voltage vs Negative Common-Mode Voltage	Figure 35
Offset Voltage vs Positive Common-Mode Voltage	Figure 36
Positive Output Voltage Swing vs Output Current	Figure 37
Negative Output Voltage Swing vs Output Current	Figure 38
Short-Circuit Current vs Temperature	Figure 39
Large-Signal Frequency Response	Figure 40
THD+N vs Frequency	Figure 41
Overshoot vs Capacitive Loads	Figure 42
Small-Signal Response, $G = 1$	Figure 43
Small-Signal Response, $G = 10$	Figure 44
Small-Signal Response, $G = 100$	Figure 45

Typical Characteristics: Table of Graphs (continued)
Table 1. Table of Graphs (continued)

DESCRIPTION	FIGURE
Small-Signal Response, $G = 1000$	Figure 46
Large-Signal Step Response	Figure 47
Closed-Loop Output Impedance	Figure 48
Differential-Mode EMI Rejection Ratio	Figure 49
Common-Mode EMI Rejection Ratio	Figure 50
Input Common-Mode Voltage vs Output Voltage, $G = 1$, $V_S = 5\text{ V}$	Figure 51
Input Common-Mode Voltage vs Output Voltage, $G = 100$, $V_S = 5\text{ V}$	Figure 52
Input Common-Mode Voltage vs Output Voltage, $V_S = \pm 5\text{ V}$	Figure 53
Input Common-Mode Voltage vs Output Voltage, $V_S = \pm 15\text{ V}$	Figure 54

7.7 Typical Characteristics

at $T_A = 25^\circ\text{C}$, $V_S = \pm 15\text{ V}$, $R_L = 10\text{ k}\Omega$, $V_{REF} = 0\text{ V}$, and $G = 1$ (unless otherwise noted)

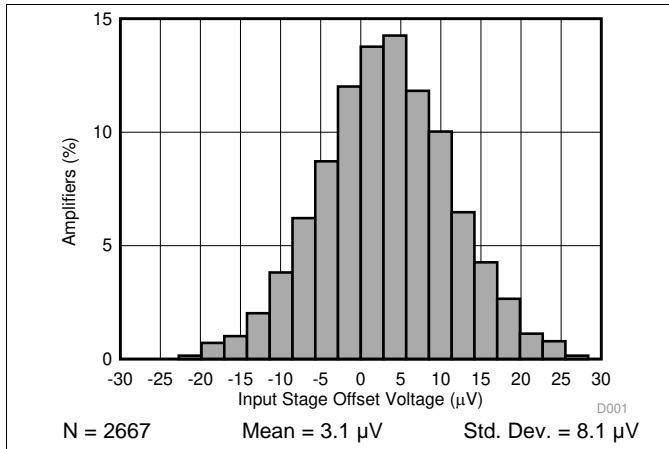

Figure 1. Typical Distribution of Input Stage Offset Voltage

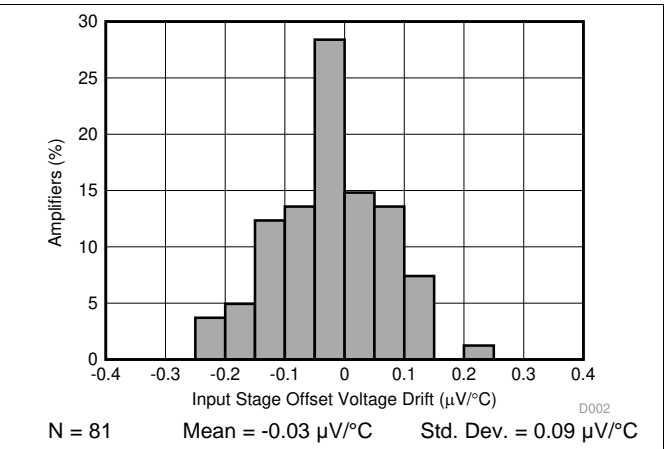

Figure 2. Typical Distribution of Input Stage Offset Voltage Drift

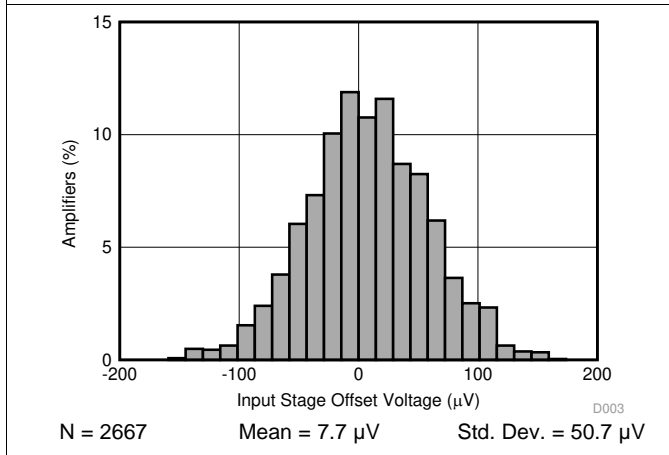

Figure 3. Typical Distribution of Output Stage Offset Voltage

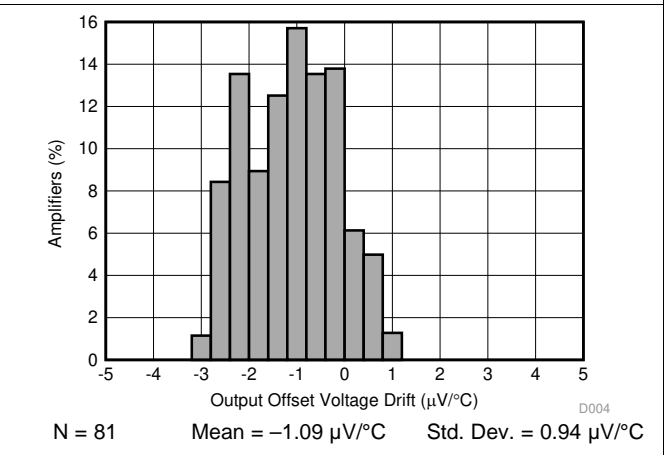

Figure 4. Typical Distribution of Output Stage Offset Voltage Drift

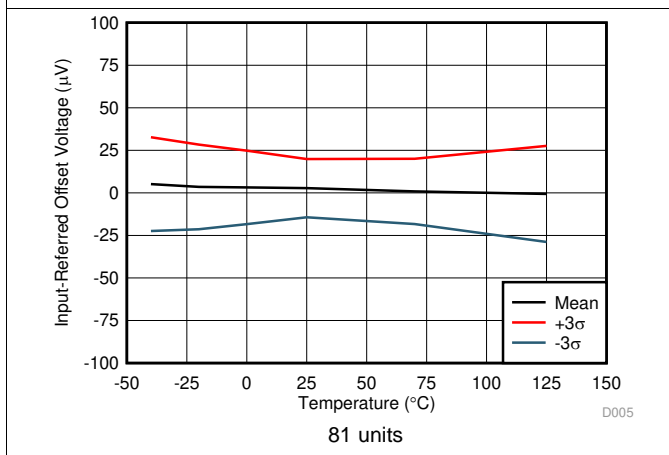

Figure 5. Input Stage Offset Voltage vs Temperature

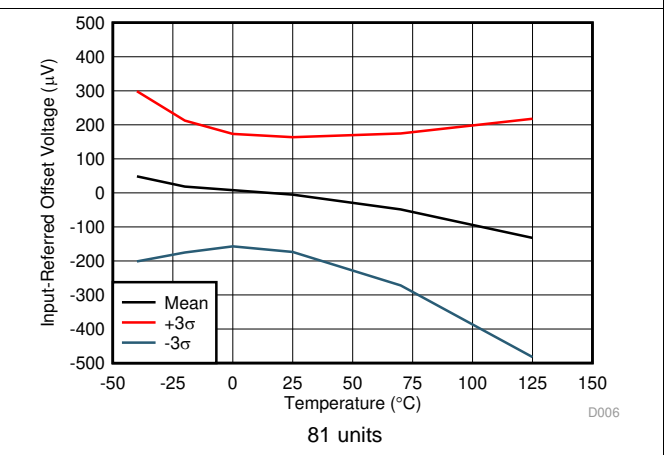
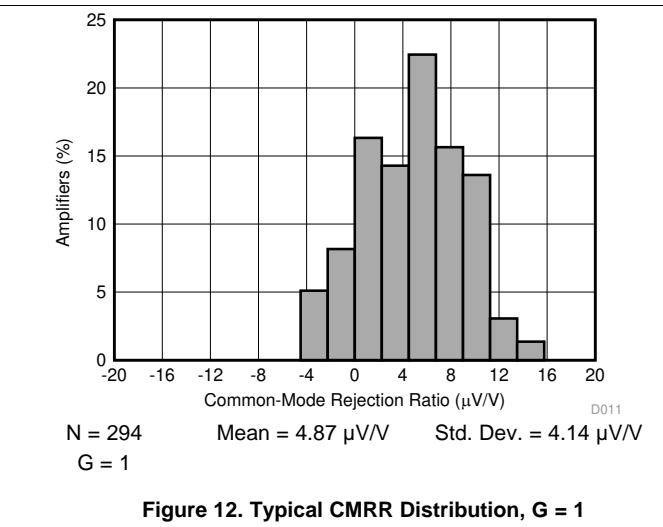
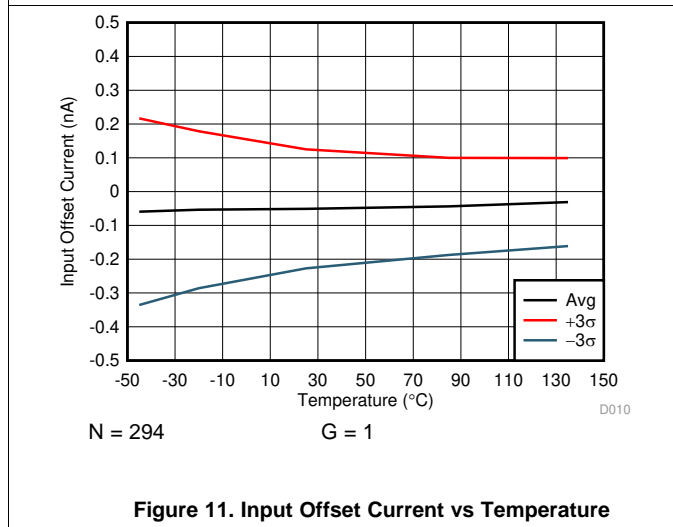
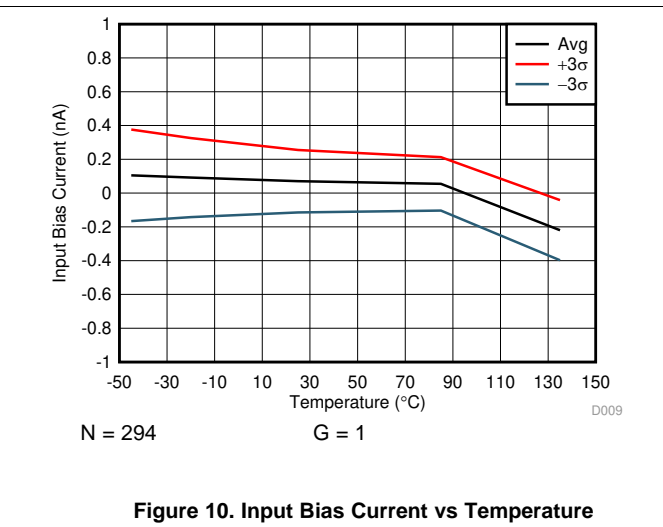
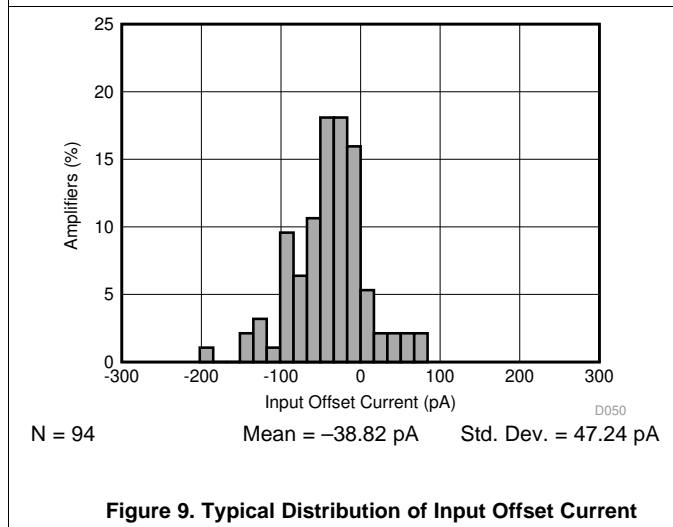
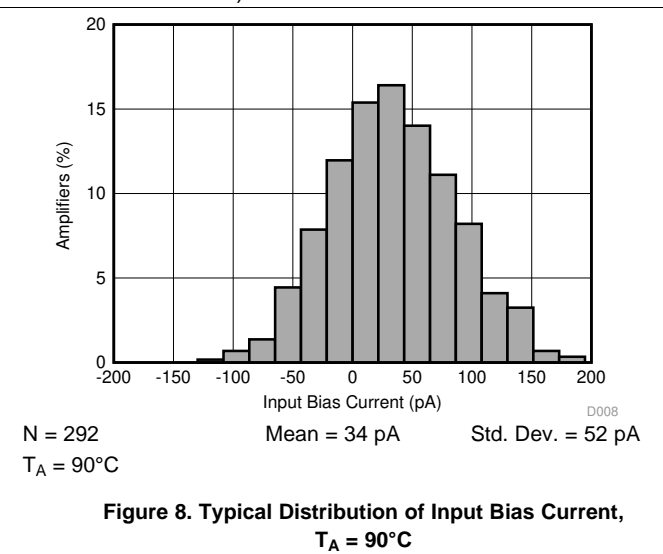
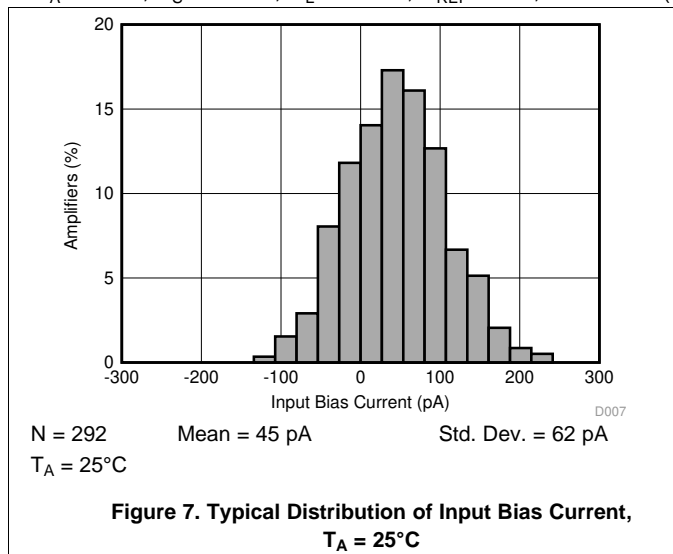

Figure 6. Output Stage Offset Voltage vs Temperature

Typical Characteristics (continued)

at $T_A = 25^\circ\text{C}$, $V_S = \pm 15\text{ V}$, $R_L = 10\text{ k}\Omega$, $V_{REF} = 0\text{ V}$, and $G = 1$ (unless otherwise noted)



Typical Characteristics (continued)

at $T_A = 25^\circ\text{C}$, $V_S = \pm 15\text{ V}$, $R_L = 10\text{ k}\Omega$, $V_{REF} = 0\text{ V}$, and $G = 1$ (unless otherwise noted)

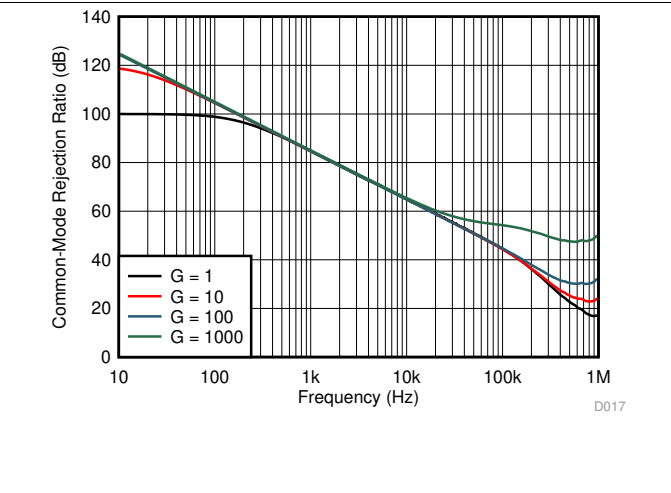
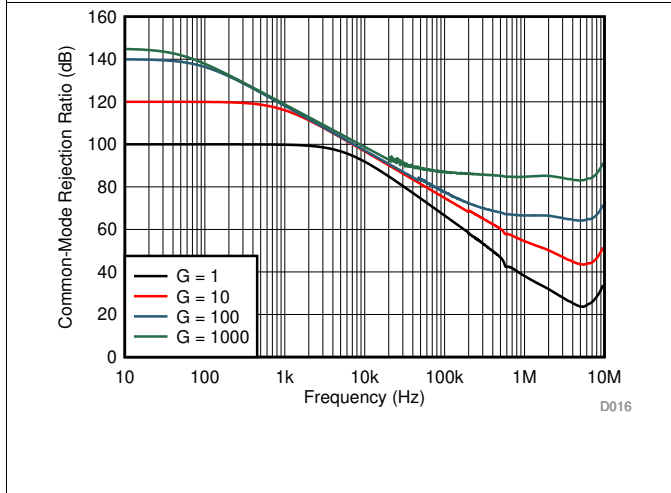
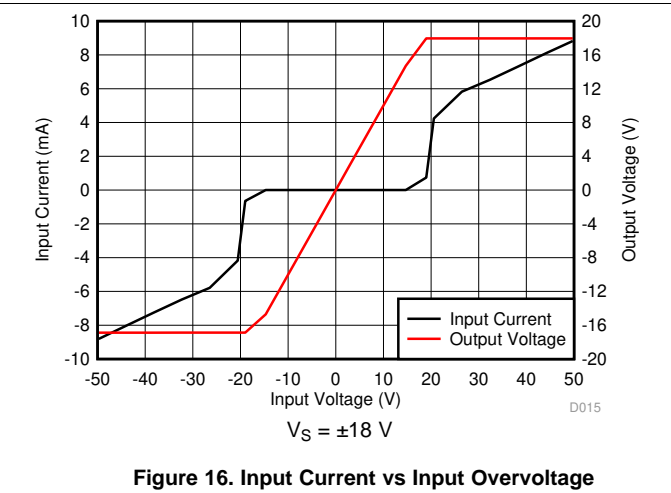
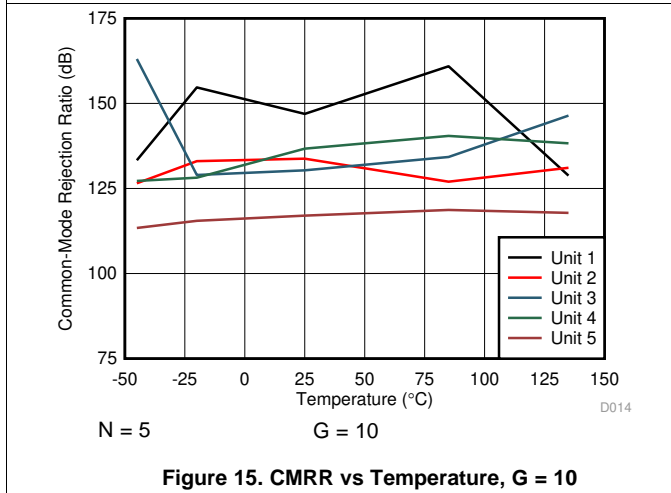
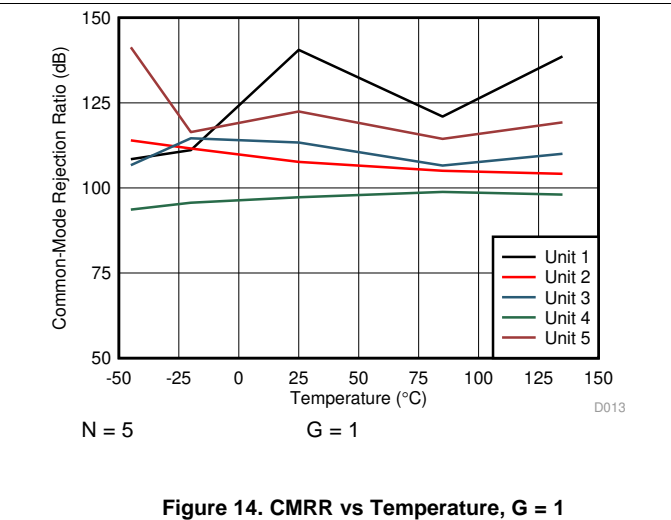
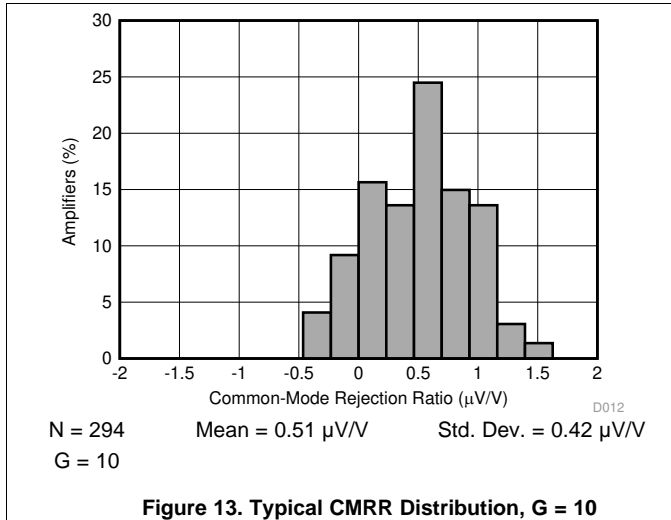

Typical Characteristics (continued)

at $T_A = 25^\circ\text{C}$, $V_S = \pm 15\text{ V}$, $R_L = 10\text{ k}\Omega$, $V_{REF} = 0\text{ V}$, and $G = 1$ (unless otherwise noted)

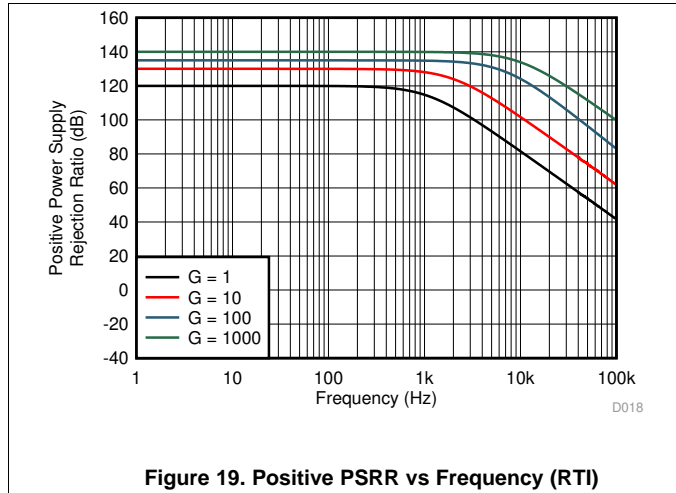

Figure 19. Positive PSRR vs Frequency (RTI)

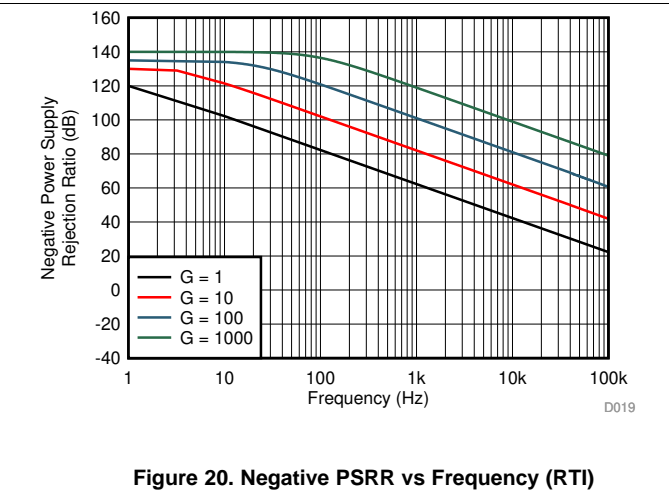

Figure 20. Negative PSRR vs Frequency (RTI)

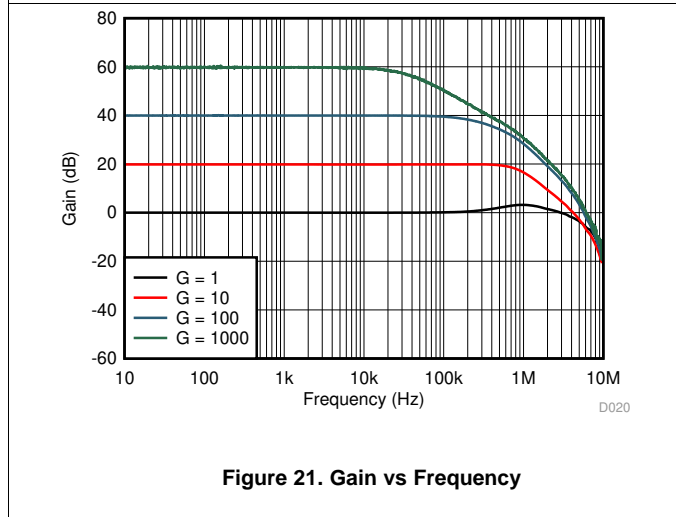

Figure 21. Gain vs Frequency

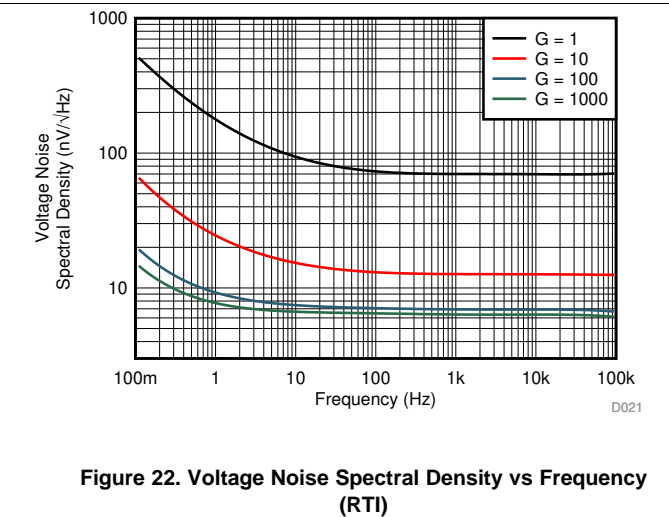

Figure 22. Voltage Noise Spectral Density vs Frequency (RTI)

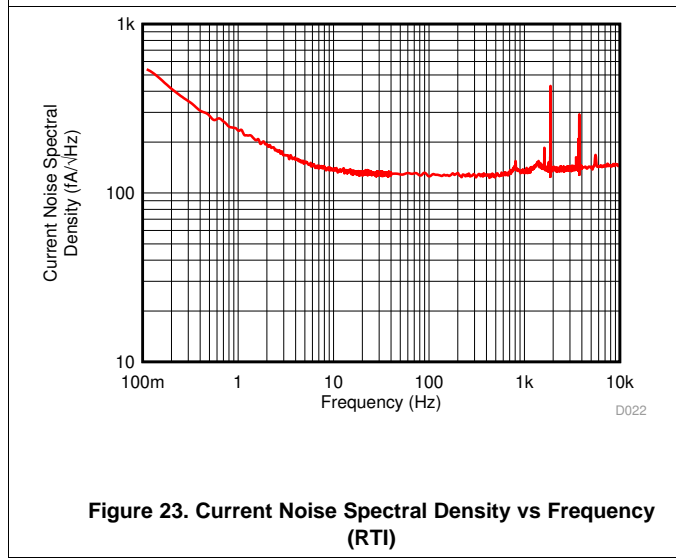

Figure 23. Current Noise Spectral Density vs Frequency (RTI)

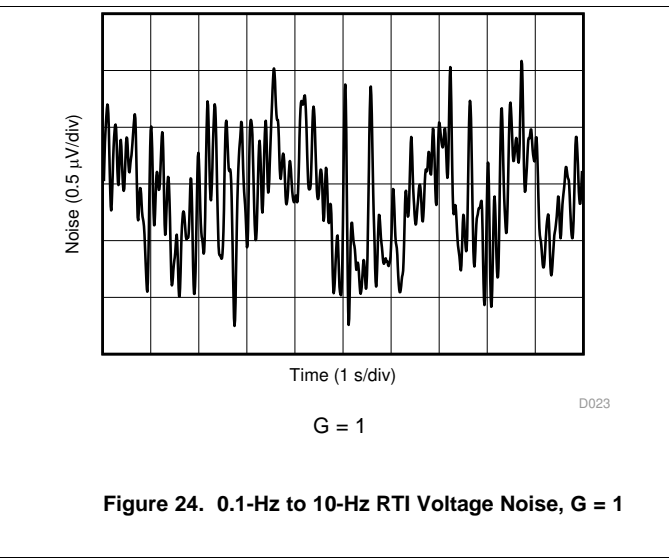

Figure 24. 0.1-Hz to 10-Hz RTI Voltage Noise, G = 1

Typical Characteristics (continued)

at $T_A = 25^\circ\text{C}$, $V_S = \pm 15\text{ V}$, $R_L = 10\text{ k}\Omega$, $V_{REF} = 0\text{ V}$, and $G = 1$ (unless otherwise noted)

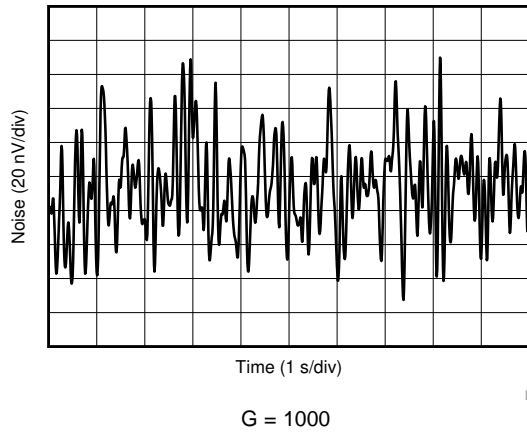

Figure 25. 0.1-Hz to 10-Hz RTI Voltage Noise, G = 1000

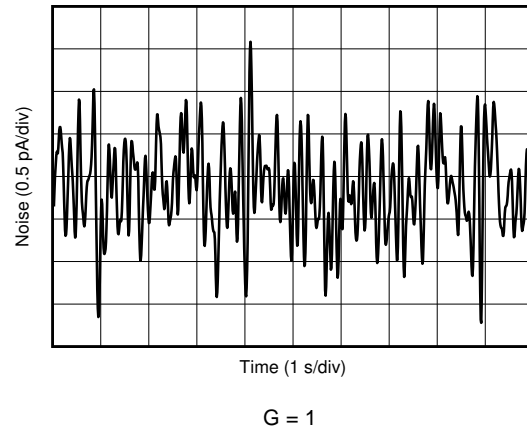

Figure 26. 0.1-Hz to 10-Hz RTI Current Noise

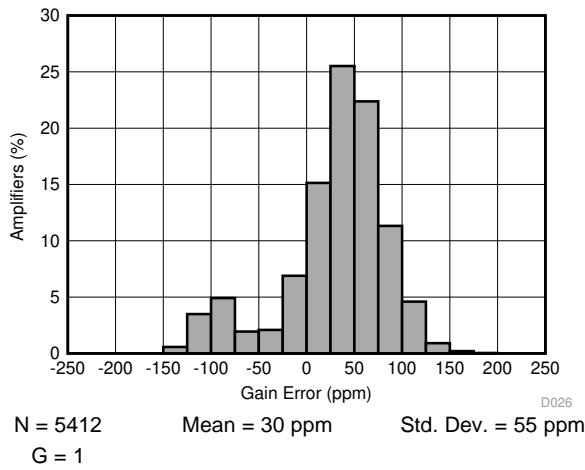

Figure 27. Typical Distribution of Gain Error, G = 1

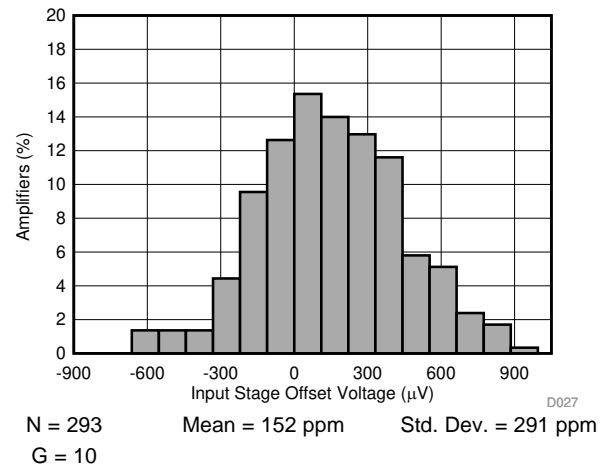

Figure 28. Typical Distribution of Gain Error, G = 10

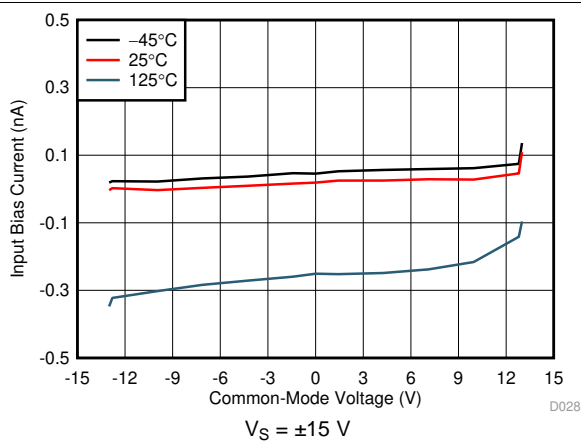

Figure 29. Input Bias Current vs Common-Mode Voltage

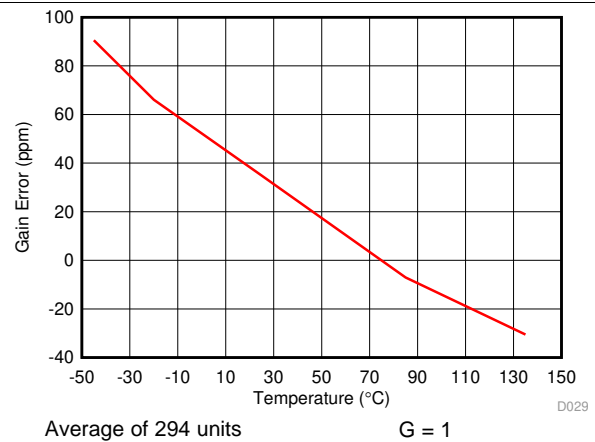

Figure 30. Gain Error vs Temperature, G = 1

Typical Characteristics (continued)

at $T_A = 25^\circ\text{C}$, $V_S = \pm 15\text{ V}$, $R_L = 10\text{ k}\Omega$, $V_{REF} = 0\text{ V}$, and $G = 1$ (unless otherwise noted)

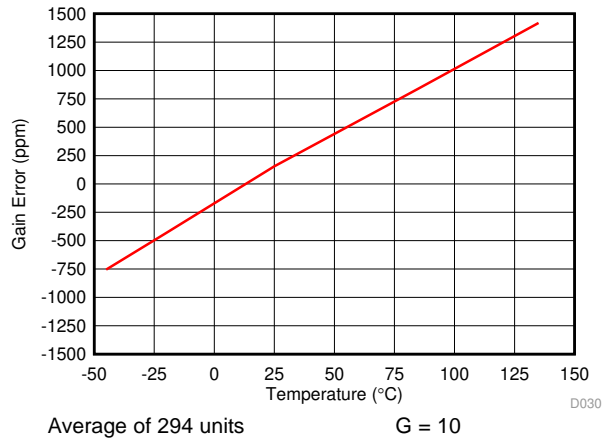

Figure 31. Gain Error vs Temperature, G = 10

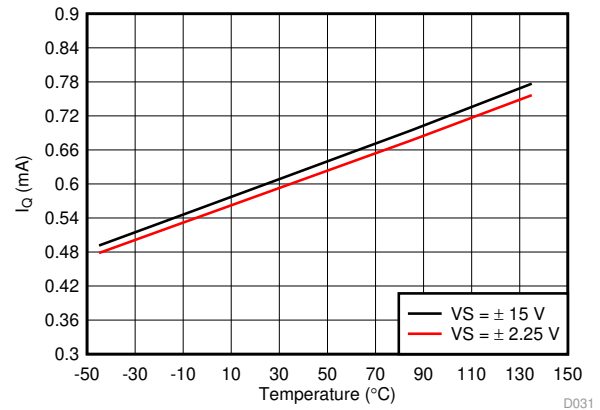

Figure 32. Supply Current vs Temperature

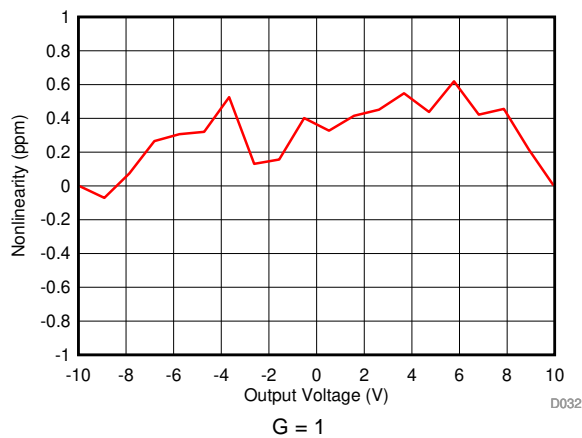

Figure 33. Gain Nonlinearity, G = 1

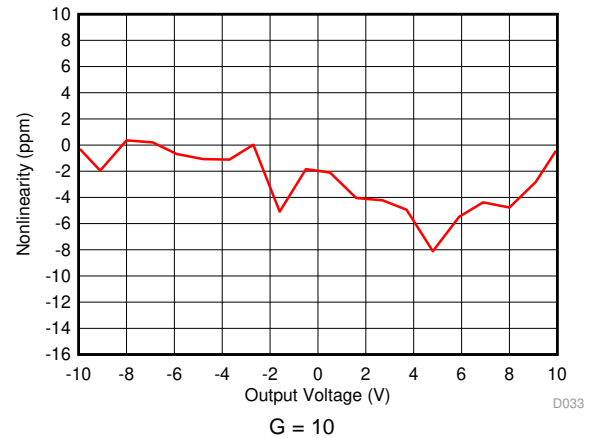

Figure 34. Gain Nonlinearity, G = 10

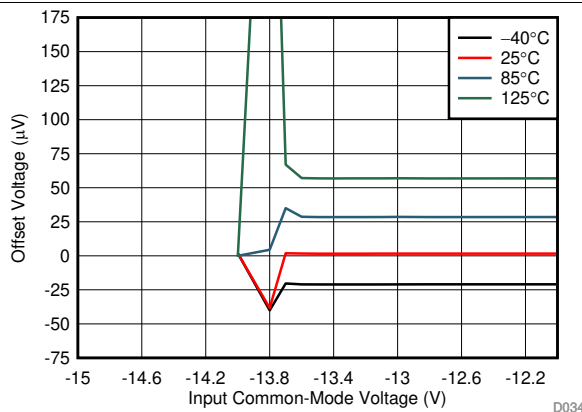

Figure 35. Offset Voltage vs Negative Common-Mode Voltage

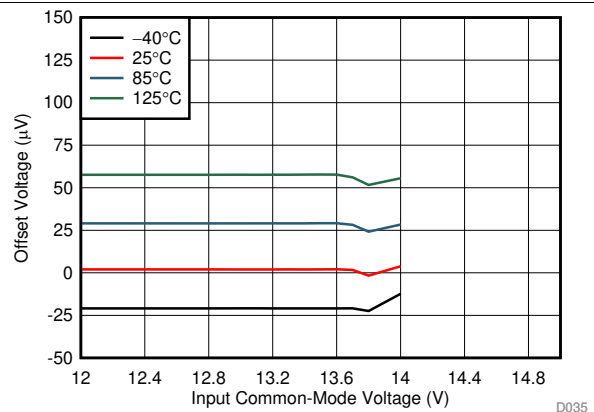

Figure 36. Offset Voltage vs Positive Common-Mode Voltage

Typical Characteristics (continued)

at $T_A = 25^\circ\text{C}$, $V_S = \pm 15\text{ V}$, $R_L = 10\text{ k}\Omega$, $V_{REF} = 0\text{ V}$, and $G = 1$ (unless otherwise noted)

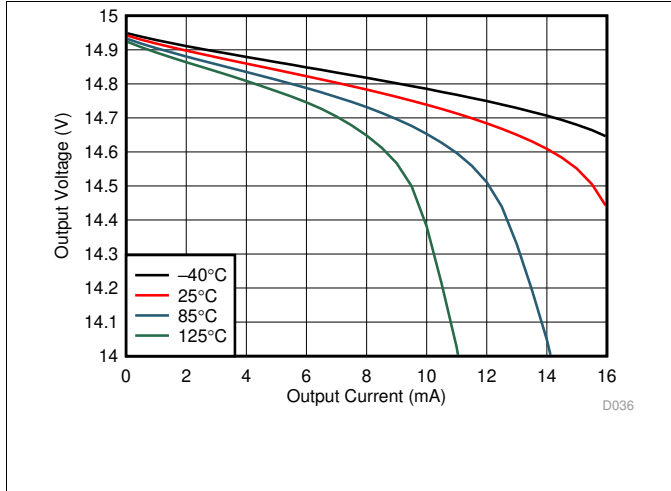

Figure 37. Positive Output Voltage Swing vs Output Current

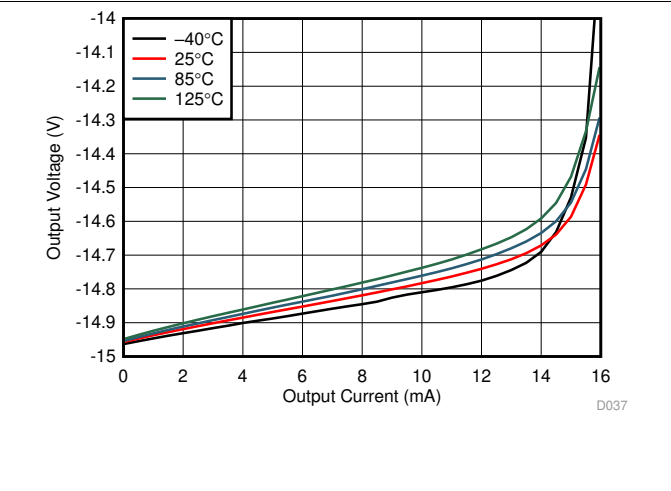

Figure 38. Negative Output Voltage Swing vs Output Current

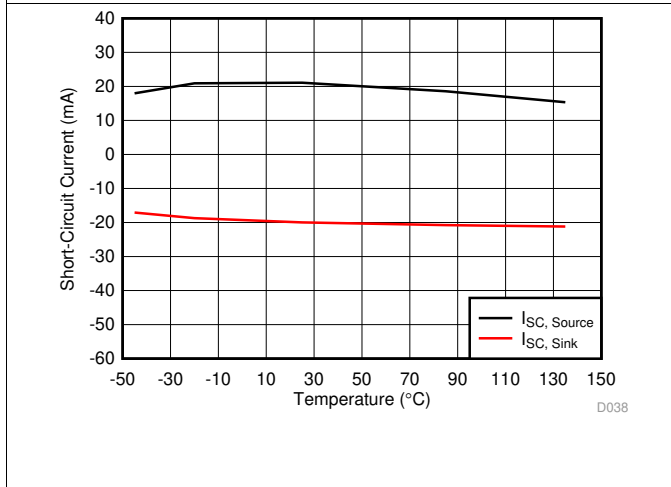

Figure 39. Short-Circuit Current vs Temperature

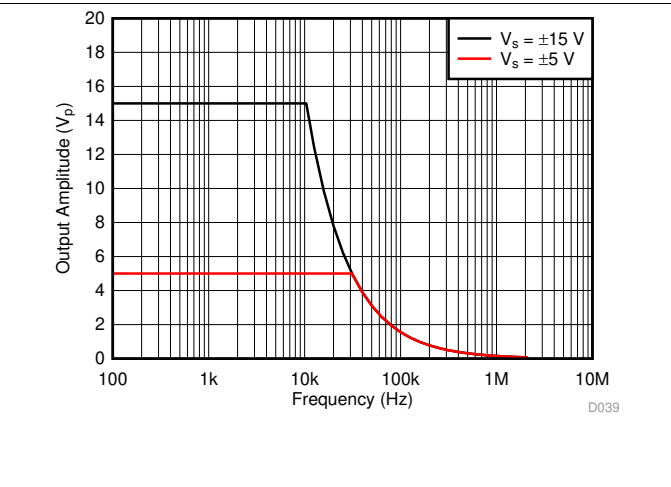

Figure 40. Large-Signal Frequency Response

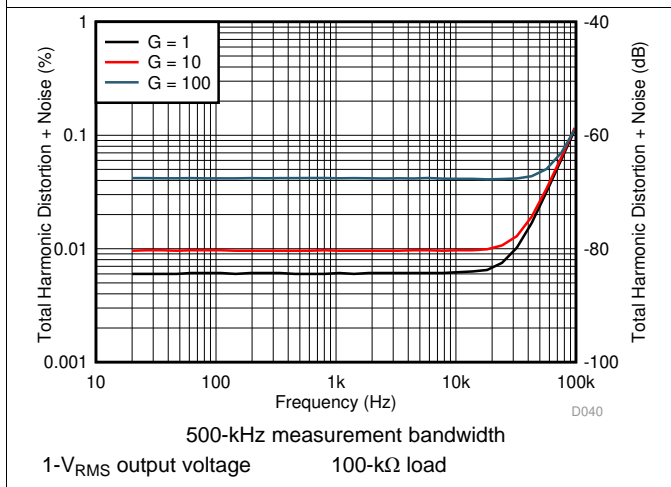

Figure 41. THD+N vs Frequency

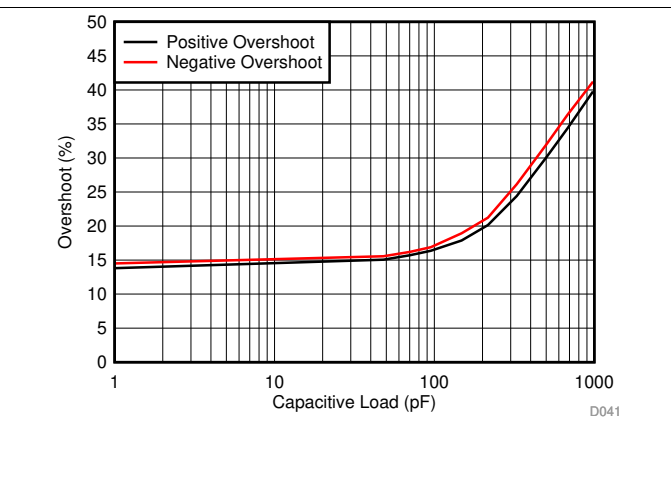

Figure 42. Overshoot vs Capacitive Loads

Typical Characteristics (continued)

at $T_A = 25^\circ\text{C}$, $V_S = \pm 15\text{ V}$, $R_L = 10\text{ k}\Omega$, $V_{\text{REF}} = 0\text{ V}$, and $G = 1$ (unless otherwise noted)

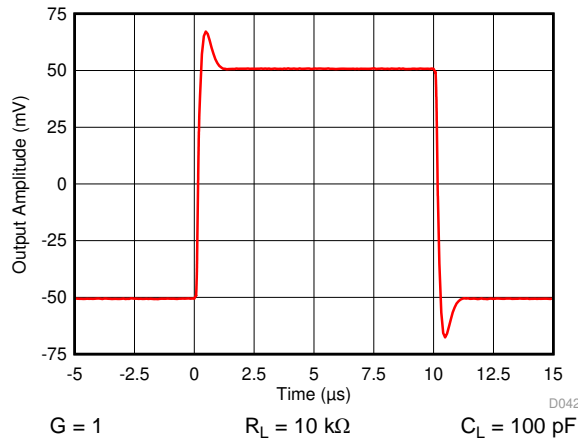

Figure 43. Small-Signal Response

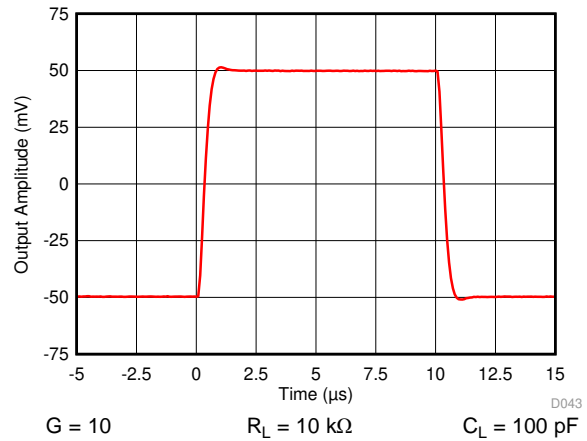

Figure 44. Small-Signal Response

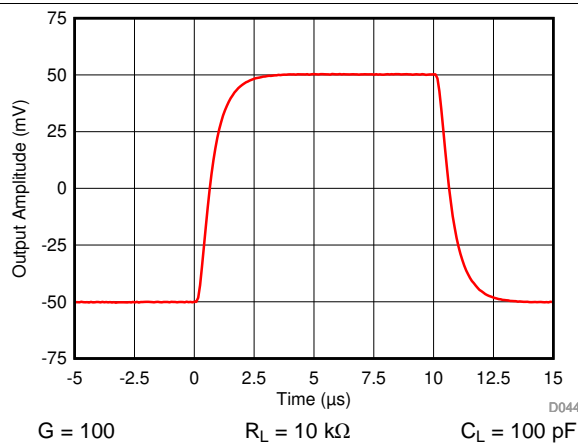

Figure 45. Small-Signal Response

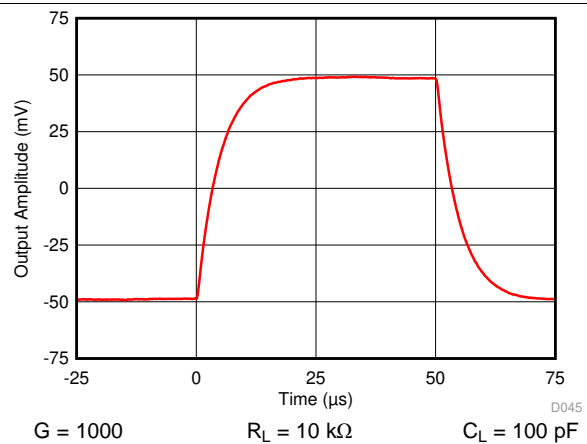

Figure 46. Small-Signal Response

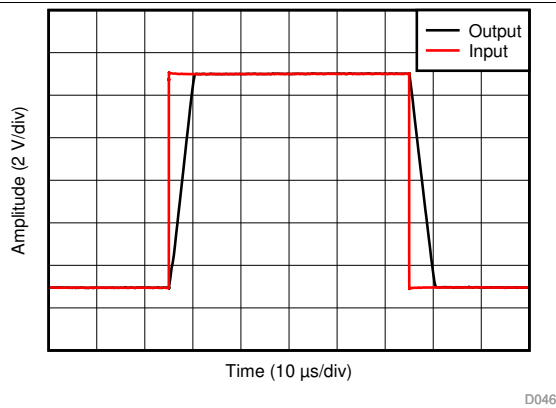

Figure 47. Large-Signal Step Response

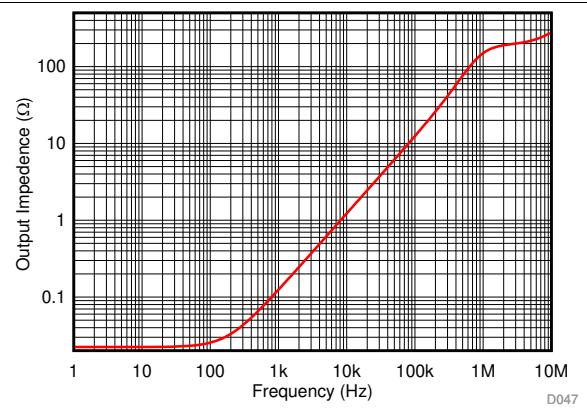

Figure 48. Closed-Loop Output Impedance

Typical Characteristics (continued)

at $T_A = 25^\circ\text{C}$, $V_S = \pm 15\text{ V}$, $R_L = 10\text{ k}\Omega$, $V_{REF} = 0\text{ V}$, and $G = 1$ (unless otherwise noted)

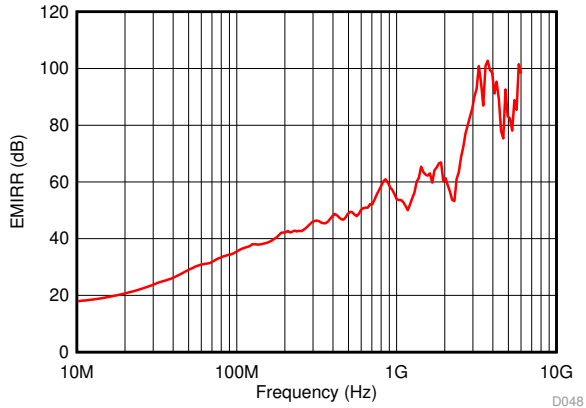

Figure 49. Differential-Mode EMI Rejection Ratio

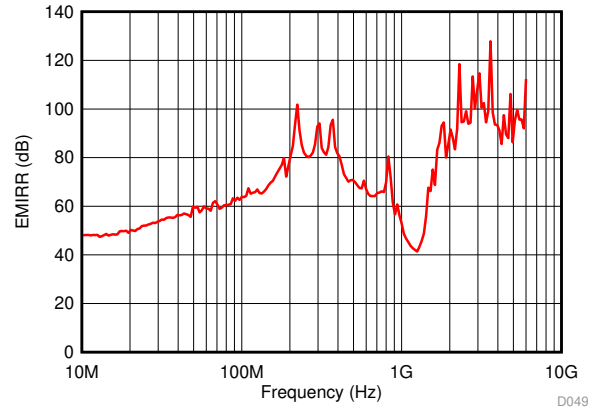

Figure 50. Common-Mode EMI Rejection Ratio

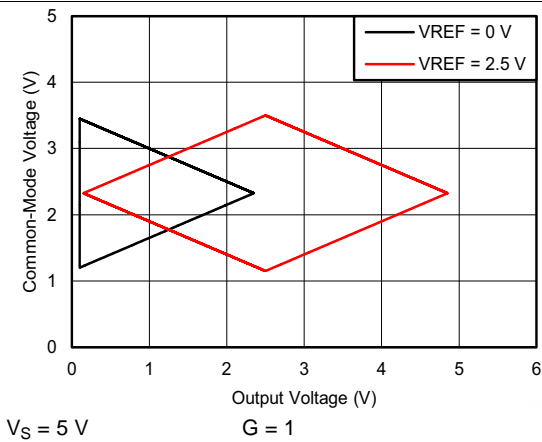

Figure 51. Input Common-Mode Voltage vs Output Voltage

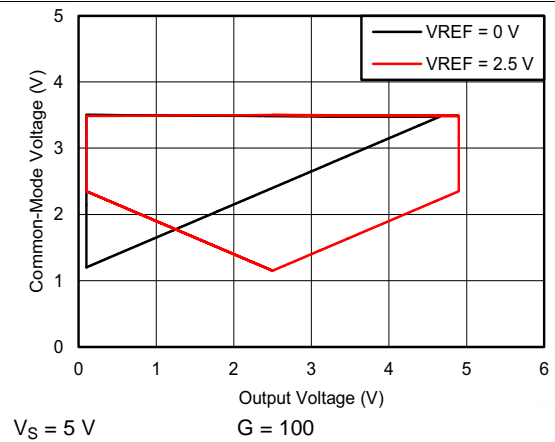

Figure 52. Input Common-Mode Voltage vs Output Voltage

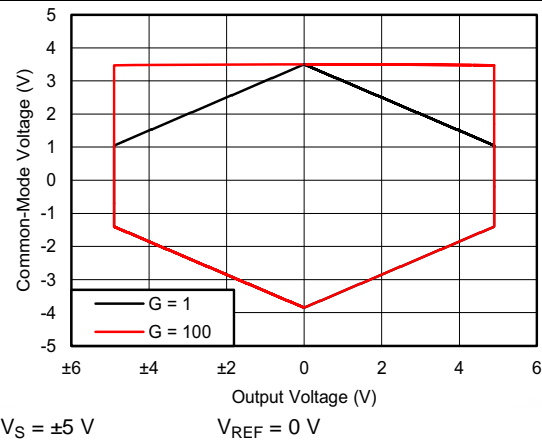

Figure 53. Input Common-Mode Voltage vs Output Voltage

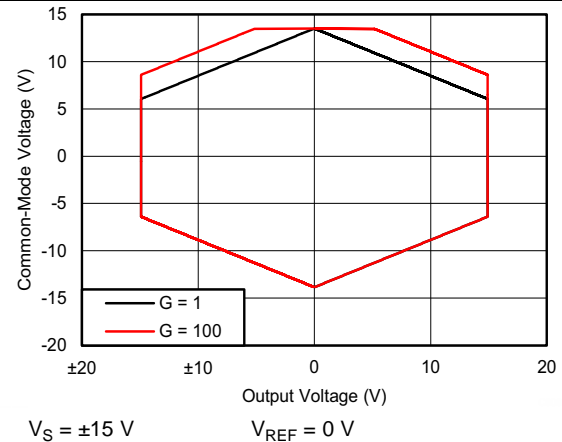

Figure 54. Input Common-Mode Voltage vs Output Voltage

8 Detailed Description

8.1 Overview

The INA821 is a monolithic precision instrumentation amplifier that incorporates a current-feedback input stage and a four-resistor difference amplifier output stage. The functional block diagram in the next section shows how the differential input voltage is buffered by Q_1 and Q_2 and is forced across R_G , which causes a signal current to flow through R_G , R_1 , and R_2 . The output difference amplifier, A_3 , removes the common-mode component of the input signal and refers the output signal to the REF pin. The V_{BE} and voltage drop across R_1 and R_2 produces output voltages on A_1 and A_2 that are approximately 0.8 V lower than the input voltages.

Each input is protected by two field-effect transistors (FETs) that provide a low series resistance under normal signal conditions, and preserve excellent noise performance. When excessive voltage is applied, these transistors limit input current to approximately 8 mA.

8.2 Functional Block Diagram

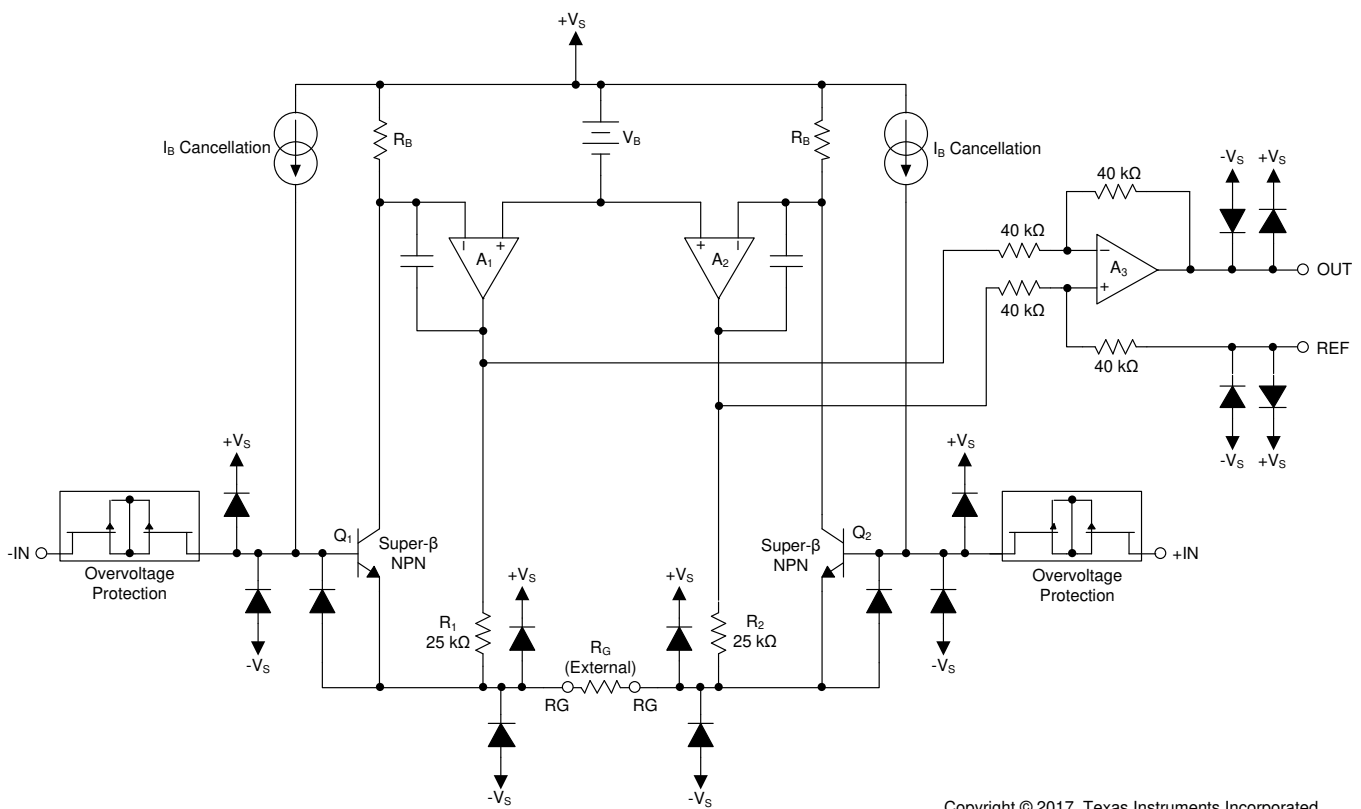

Copyright © 2017, Texas Instruments Incorporated

8.3 Feature Description

8.3.1 Setting the Gain

Figure 55 shows that the gain of the INA821 is set by a single external resistor (R_G) connected between the RG pins (pins 1 and 8).

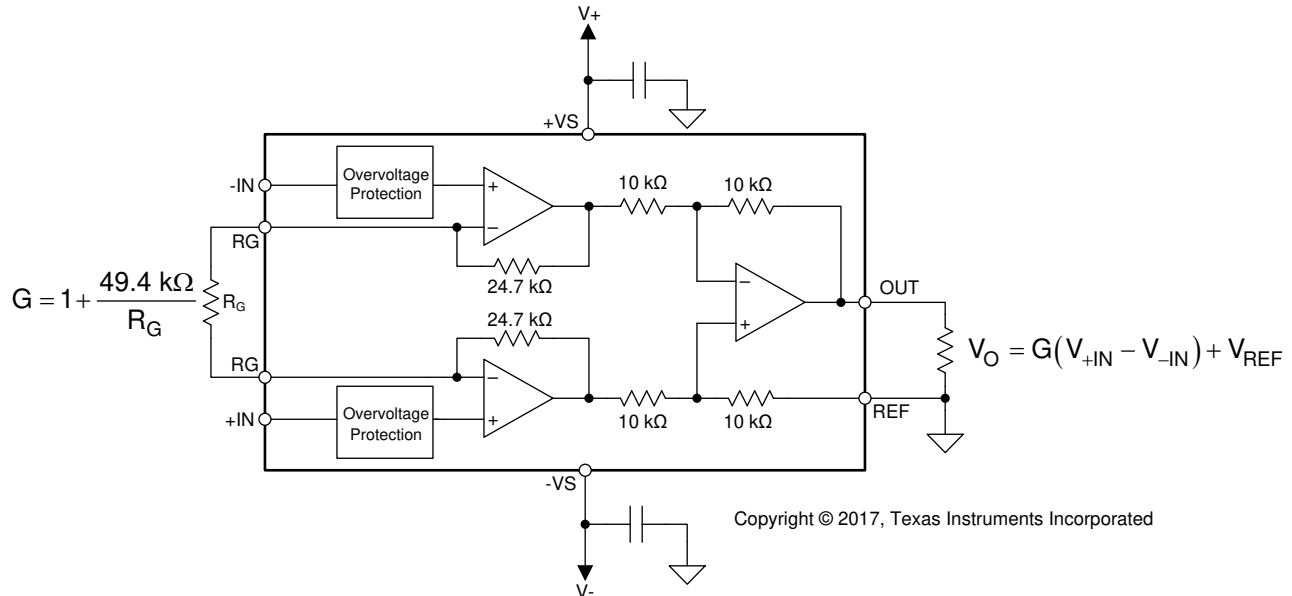

Figure 55. Simplified Diagram of the INA821 With Gain and Output Equations

The value of R_G is selected according to:

$$G = 1 + \frac{49.4 \text{ k}\Omega}{R_G} \quad (1)$$

Table 2 lists several commonly used gains and resistor values. The 49.4-k Ω term in Equation 1 is a result of the sum of the two internal 24.7-k Ω feedback resistors. These on-chip resistors are laser-trimmed to accurate absolute values. The accuracy and temperature coefficients of these resistors are included in the gain accuracy and drift specifications of the INA821. As shown in Figure 55 and explained in more details in the Layout section, make sure to connect low-ESR, 0.1- μ F ceramic bypass capacitors between each supply pin and ground, that are placed as close to the device as possible.

Table 2. Commonly-Used Gains and Resistor Values

DESIRED GAIN	R_G (Ω)	NEAREST 1% R_G (Ω)
1	NC	NC
2	49.4 k	49.9 k
5	12.35 k	12.4 k
10	5.489 k	5.49 k
20	2.600 k	2.61 k
50	1.008 k	1 k
100	499	499
200	248	249
500	99	100
1000	49.4	49.9

8.3.1.1 Gain Drift

The stability and temperature drift of the external gain setting resistor (R_G) also affects gain. The contribution of R_G to gain accuracy and drift is determined from Equation 1.

The best gain drift of 5 ppm/°C (maximum) is achieved when the INA821 uses $G = 1$ without R_G connected. In this case, gain drift is limited by the slight mismatch of the temperature coefficient of the integrated 10-k Ω resistors in the differential amplifier (A_3). At gains greater than 1, gain drift increases as a result of the individual drift of the 24.7-k Ω resistors in the feedback of A_1 and A_2 relative to the drift of the external gain resistor (R_G). The low temperature coefficient of the internal feedback resistors significantly improves the overall temperature stability of applications using gains greater than 1 V/V over alternate options.

Low resistor values required for high gain make wiring resistance an important consideration. Sockets add to the wiring resistance and contribute additional gain error (such as a possible unstable gain error) at gains of approximately 100 or greater. To maintain stability, avoid parasitic capacitance of more than a few picofarads at R_G connections. Careful matching of any parasitics on the R_G pins maintains optimal CMRR over frequency; see Figure 17.

8.3.2 EMI Rejection

Texas Instruments developed a method to accurately measure the immunity of an amplifier over a broad frequency spectrum extending from 10 MHz to 6 GHz. This method uses an EMI rejection ratio (EMIRR) to quantify the ability of the INA821 to reject EMI. The offset resulting from an input EMI signal is calculated using Equation 2:

$$\Delta V_{OS} = \left(\frac{V_{RF_PEAK}^2}{100 \text{ mV}_P} \right) \cdot 10^{-\left(\frac{EMIRR \text{ (dB)}}{20} \right)}$$

where

- V_{RF_PEAK} is the peak amplitude of the input EMI signal. (2)

Figure 56 and Figure 57 show the INA821 EMIRR graph for differential and common-mode EMI rejection across this frequency range. Table 3 lists the EMIRR values for the INA821 at frequencies commonly encountered in real-world applications. Applications listed in Table 3 are centered on or operated near the particular frequency shown. Depending on the end-system requirements, additional EMI filters may be required near the signal inputs of the system. Incorporating known good practices, such as using short traces, low-pass filters, and damping resistors combined with parallel and shielded signal routing, may be required.

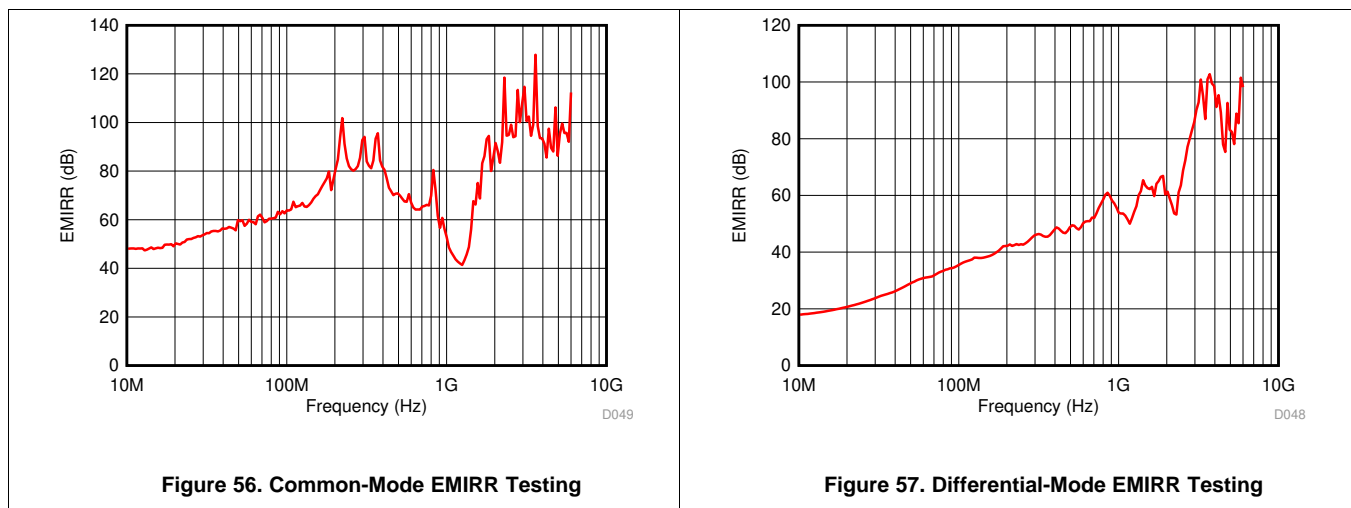
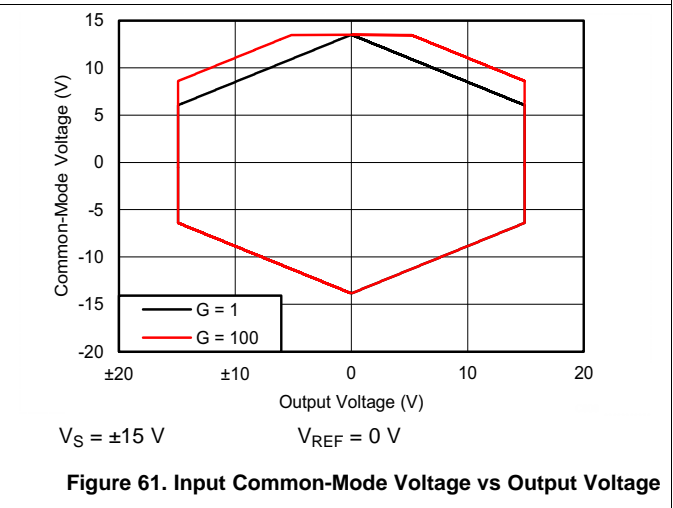
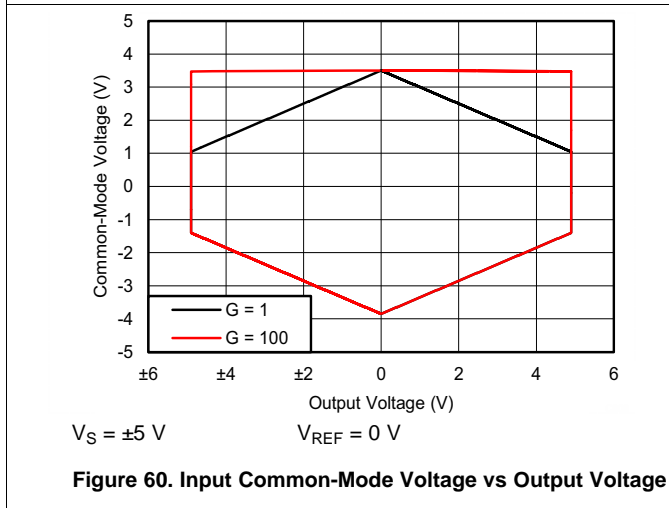
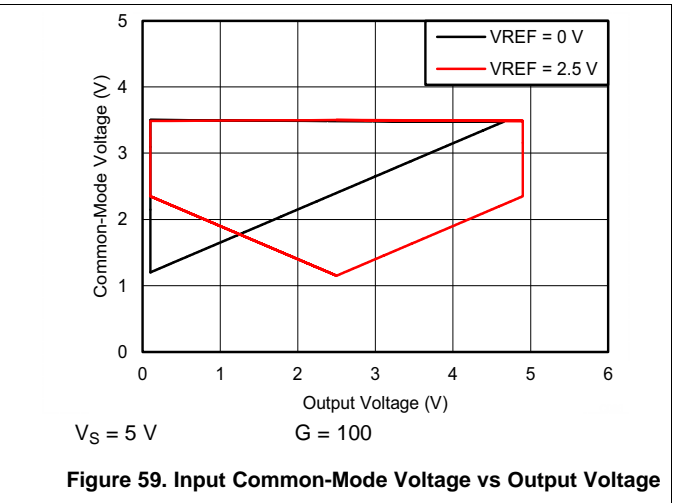
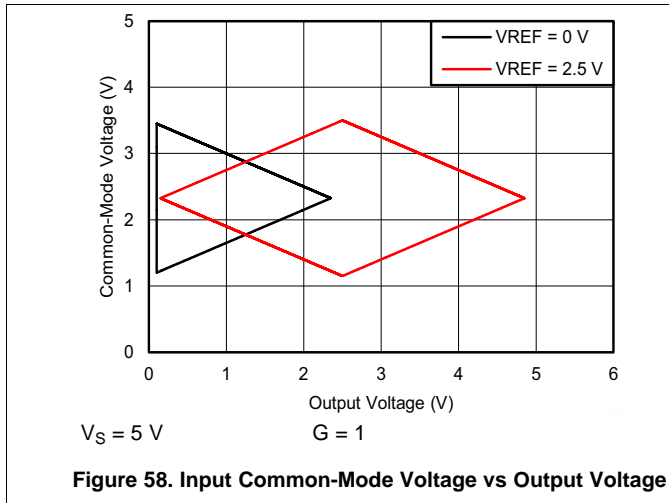

Table 3. INA821 EMIRR for Frequencies of Interest

FREQUENCY	APPLICATION OR ALLOCATION	DIFFERENTIAL EMIRR	COMMON-MODE EMIRR
400 MHz	Mobile radio, mobile satellite, space operation, weather, radar, ultrahigh-frequency (UHF) applications	60 dB	88 dB
900 MHz	Global system for mobile communications (GSM) applications, radio communication, navigation, GPS (up to 1.6 GHz), GSM, aeronautical mobile, UHF applications	58 dB	60 dB
1.8 GHz	GSM applications, mobile personal communications, broadband, satellite, L-band (1 GHz to 2 GHz)	66 dB	89 dB
2.4 GHz	802.11b, 802.11g, 802.11n, Bluetooth®, mobile personal communications, industrial, scientific and medical (ISM) radio band, amateur radio and satellite, S-band (2 GHz to 4 GHz)	73 dB	98 dB
3.6 GHz	Radiolocation, aero communication and navigation, satellite, mobile, S-band	99 dB	111 dB
5 GHz	802.11a, 802.11n, aero communication and navigation, mobile communication, space and satellite operation, C-band (4 GHz to 8 GHz)	83 dB	91 dB

8.3.3 Input Common-Mode Range

The linear input voltage range of the INA821 input circuitry extends within 2 V of power supplies and maintains excellent common-mode rejection throughout this range. The common-mode range for the most common operating conditions are shown in Figure 58 to Figure 61. The common-mode range for other operating conditions is best calculated using the [Common-Mode Input Range Calculator for Instrumentation Amplifiers](#).



8.3.4 Input Protection

The inputs of the INA821 device are individually protected for voltages up to ± 40 V. For example, a condition of -40 V on one input and $+40$ V on the other input does not cause damage. Internal circuitry on each input provides low series impedance under normal signal conditions. If the input is overloaded, the protection circuitry limits the input current to a value of approximately 8 mA.

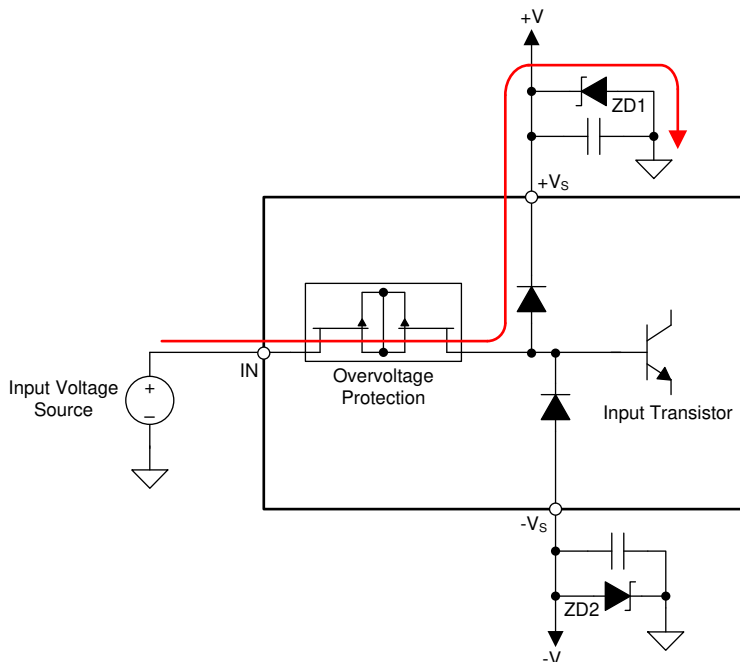

Figure 62. Input Current Path During an Overvoltage Condition

During an input overvoltage condition, current flows through the input protection diodes into the power supplies, as shown in Figure 62. If the power supplies are unable to sink current, then Zener diode clamps (ZD1 and ZD2 in Figure 62) must be placed on the power supplies to provide a current pathway to ground. Figure 63 shows the input current for input voltages from -40 V to $+40$ V when the INA821 is powered by ± 15 -V supplies.

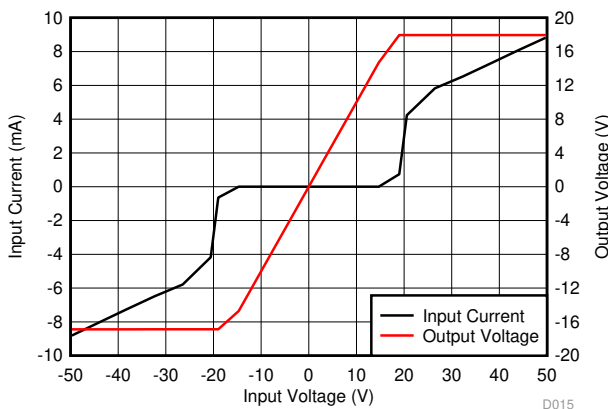

Figure 63. Input Current vs Input Overvoltage

8.3.5 Operating Voltage

The INA821 operates over a power-supply range of 4.5 V to 36 V (± 2.25 V to ± 18 V).

CAUTION

Supply voltages higher than 40 V (± 20 V) can permanently damage the device. Parameters that vary over supply voltage or temperature are shown in the *Typical Characteristics* section of this data sheet.

8.3.6 Error Sources

Most modern signal-conditioning systems calibrate errors at room temperature. However, calibration of errors that result from a change in temperature is normally difficult and costly. Therefore, minimize these errors by choosing high-precision components, such as the INA821, that have improved specifications in critical areas that impact the precision of the overall system. Figure 64 shows an example application.

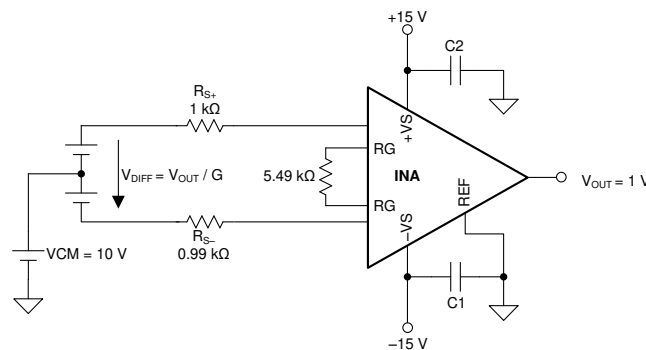

Figure 64. Example Application With $G = 10$ V/V and a 1-V Output Voltage

Resistor-adjustable devices (such as the INA821) show the lowest gain error in $G = 1$ because of the inherently well-matched drift of the internal resistors of the differential amplifier. At gains greater than 1 (for instance, $G = 10$ V/V or $G = 100$ V/V), the gain error becomes a significant error source because of the contribution of the resistor drift of the 24.7-k Ω feedback resistors in conjunction with the external gain resistor. Except for very high gain applications, the gain drift is by far the largest error contributor compared to other drift errors, such as offset drift.

The INA821 offers excellent gain error over temperature for both $G > 1$ and $G = 1$ (no external gain resistor). Table 5 summarizes the major error sources in common INA applications and compares the three cases of $G = 1$ (no external resistor) and $G = 10$ (5.49-k Ω external resistor) and $G = 100$ (499- Ω external resistor). All calculations are assuming an output voltage of $V_{OUT} = 1$ V. Thus, the input signal V_{DIFF} (given by $V_{DIFF} = V_{OUT}/G$) exhibits smaller and smaller amplitudes with increasing gain G . In this example, $V_{DIFF} = 1$ mV at $G = 1000$. All calculations refer the error to the input for easy comparison and system evaluation. As Table 5 shows, errors generated by the input stage (such as input offset voltage) are more dominant at higher gain, while the effects of output stage are suppressed because they are divided by the gain when referring them back to the input. The gain error and gain drift error are much more significant for gains greater than 1 because of the contribution of the resistor drift of the 24.7-k Ω feedback resistors in conjunction with the external gain resistor. In most applications, static errors (absolute accuracy errors) can readily be removed during calibration in production, while the drift errors are the key factors limiting overall system performance.

Table 4. System Specifications for Error Calculation

QUANTITY	VALUE	UNIT
V _{OUT}	1	V
V _{CM}	10	V
V _S	1	V
R _{S+}	1000	Ω
R _{S-}	999	Ω
RG tolerance	0.01	%
RG drift	10	ppm/°C
Temperature range upper limit	105	°C

Table 5. Error Calculation

ERROR SOURCE	ERROR CALCULATION	INA821 VALUES				
		SPECIFICATION	UNIT	G = 1 ERROR (ppm)	G = 100 ERROR (ppm)	G = 1000 ERROR (ppm)
ABSOLUTE ACCURACY AT 25°C						
Input offset voltage	V _{OSI} / V _{DIFF}	35	μV	35	350	3500
Output offset voltage	V _{OSO} / (G × V _{DIFF})	300	μV	350	350	350
Input offset current	I _{OS} × maximum (R _{S+} , R _{S-}) / V _{DIFF}	0.5	nA	1	5	50
CMRR (min)	V _{CM} / (10 ^{CMRR/20} × V _{DIFF})	92 (G = 1), 112 (G = 10), 132 (G = 100)	dB	251	251	251
PSRR (min)	(V _{CC} - V _S) / (10 ^{PSRR/20} × V _{DIFF})	110 (G = 1), 114 (G = 10), 130 (G = 100)	dB	3	20	32
Gain error from INA (max)	GE(%) × 10 ⁴	0.02 (G = 1), 0.15 (G = 10, 100)	%	200	1500	1500
Gain error from external resistor RG (max)	GE(%) × 10 ⁴	0.01	%	100	100	100
Total absolute accuracy error (ppm) at 25°C, worst case	sum of all errors	—	—	940	2576	5738
Total absolute accuracy error (ppm) at 25°C, average	rms sum of all errors	—	—	487	1603	3834
DRIFT TO 105°C						
Gain drift from INA (max)	GTC × (T _A - 25)	5 (G = 1), 35 (G = 10, 100)	ppm/°C	400	2800	2800
Gain drift from external resistor RG (max)	GTC × (T _A - 25)	10	ppm/°C	800	800	800
Input offset voltage drift (max)	(V _{OSI_TC} / V _{DIFF}) × (T _A - 25)	0.4	μV/°C	32	320	3200
Output offset voltage drift	[V _{OSO_TC} / (G × V _{DIFF})] × (T _A - 25)	5	μV/°C	400	400	400
Offset current drift	I _{OS_TC} × maximum (R _{S+} , R _{S-}) × (T _A - 25) / V _{DIFF}	20	pA/°C	2	16	160
Total drift error to 105°C (ppm), worst case	sum of all errors	—	—	1634	4336	7360
Total drift error to 105°C (ppm), typical	rms sum of all errors	—	—	980	2957	4348
RESOLUTION						
Gain nonlinearity		10 (G = 1, 10), 15 (G = 100)	ppm of FS	10	10	15
Voltage noise (at 1 kHz)	$\sqrt{BW} \times \sqrt{e_{NI}^2 + \left(\frac{e_{NO}}{G}\right)^2} \times \frac{6}{V_{DIFF}}$	e _{NI} = 7, e _{NO} = 65	μV _{PP}	1335	886	3566
Current noise (at 1 kHz)	I _N × maximum (R _{S+} , R _{S-}) × √BW / V _{DIFF}	0.13	pA/√Hz	0.4	2	11
Total resolution error (ppm), worst case	sum of all errors	—	—	1345	896	3581
Total resolution error (ppm), typical	rms sum of all errors	—	—	1335	886	3566
TOTAL ERROR						
Total error (ppm), worst case	sum of all errors	—	—	3919	7808	16724
Total error (ppm), typical	rms sum of all errors	—	—	1726	3478	6806

8.4 Device Functional Modes

The INA821 has a single functional mode and is operational when the power supply voltage is greater than 4.5 V (± 2.25 V). The maximum power-supply voltage for the INA821 is 36 V (± 18 V).

9 Application and Implementation

NOTE

Information in the following applications sections is not part of the TI component specification, and TI does not warrant its accuracy or completeness. TI's customers are responsible for determining suitability of components for their purposes. Customers should validate and test their design implementation to confirm system functionality.

9.1 Application Information

9.1.1 Reference Pin

The output voltage of the INA821 is developed with respect to the voltage on the reference pin (REF.) Often in dual-supply operation, REF (pin 6) connects to the low-impedance system ground. In single-supply operation, offsetting the output signal to a precise midsupply level is useful (for example, 2.5 V in a 5-V supply environment). To accomplish this level shift, a voltage source must be connected to the REF pin to level-shift the output so that the INA821 drives a single-supply analog-to-digital converter (ADC).

The voltage source applied to the reference pin must have a low output impedance. As shown in [Figure 65](#), any resistance at the reference pin (R_{REF} in [Figure 65](#)) is in series with one of the internal 10-k Ω resistors.

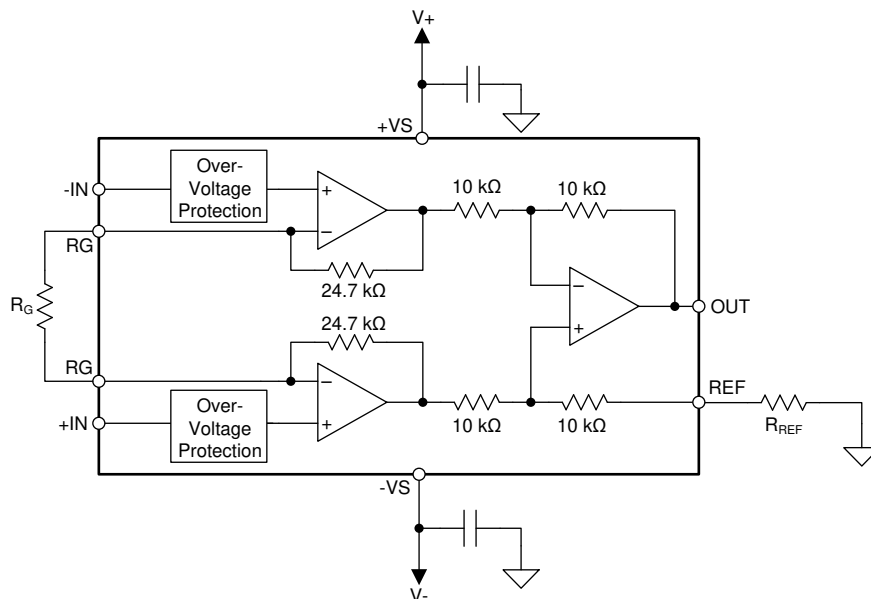

Figure 65. Parasitic Resistance Shown at the Reference Pin

Application Information (continued)

The parasitic resistance at the reference pin (R_{REF}) creates an imbalance in the four resistors of the internal difference amplifier that results in a degraded common-mode rejection ratio (CMRR). Figure 66 shows the degradation in CMRR of the INA821 as a result of the increased resistance at the reference pin. For the best performance, keep the source impedance to the REF pin (R_{REF}) less than 5 Ω .

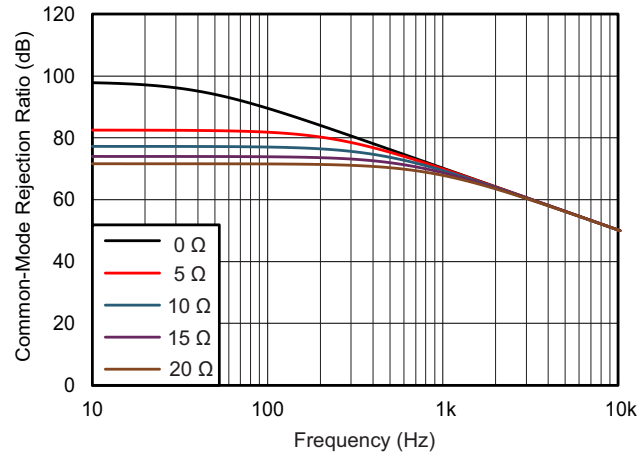
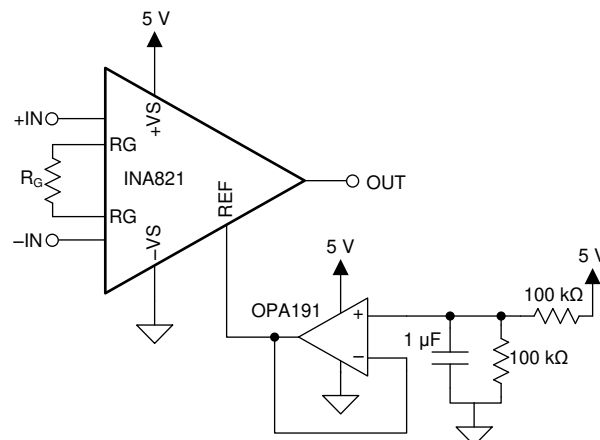

Figure 66. The Effect of Increasing Resistance at the Reference Pin

Voltage reference devices are an excellent option for providing a low-impedance voltage source for the reference pin. However, if a resistor voltage divider generates a reference voltage, buffer the divider by an op amp, as shown in Figure 67, to avoid CMRR degradation.



Copyright © 2017, Texas Instruments Incorporated

Figure 67. Use an Op Amp to Buffer Reference Voltages

Application Information (continued)

9.1.2 Input Bias Current Return Path

The input impedance of the INA821 is extremely high (approximately 100 G Ω .) However, a path must be provided for the input bias current of both inputs. This input bias current is typically 150 pA. High input impedance means that this input bias current changes little with varying input voltage.

For proper operation, Input circuitry must provide a path for this input bias current. [Figure 68](#) shows various provisions for an input bias current path. Without a bias current path, the inputs float to a potential that exceeds the common-mode range of the INA821 and the input amplifiers saturate. If the differential source resistance is low, the bias current return path connects to one input (as shown in the thermocouple example in [Figure 68](#)). With a higher source impedance, using two equal resistors provides a balanced input with possible advantages of a lower input offset voltage as a result of bias current and better high-frequency common-mode rejection.

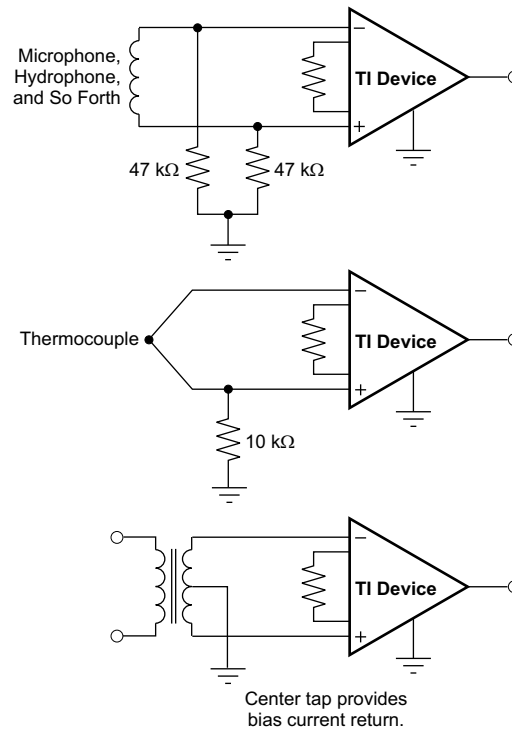

Copyright © 2017, Texas Instruments Incorporated

Figure 68. Providing an Input Common-Mode Current Path

9.2 Typical Application

Figure 69 shows a three-pin programmable-logic controller (PLC) design for the INA821. This PLC reference design accepts inputs of ± 10 V or ± 20 mA. The output is a single-ended voltage of 2.5 V ± 2.3 V (or 200 mV to 4.8 V). Typically, PLCs have these input and output ranges.

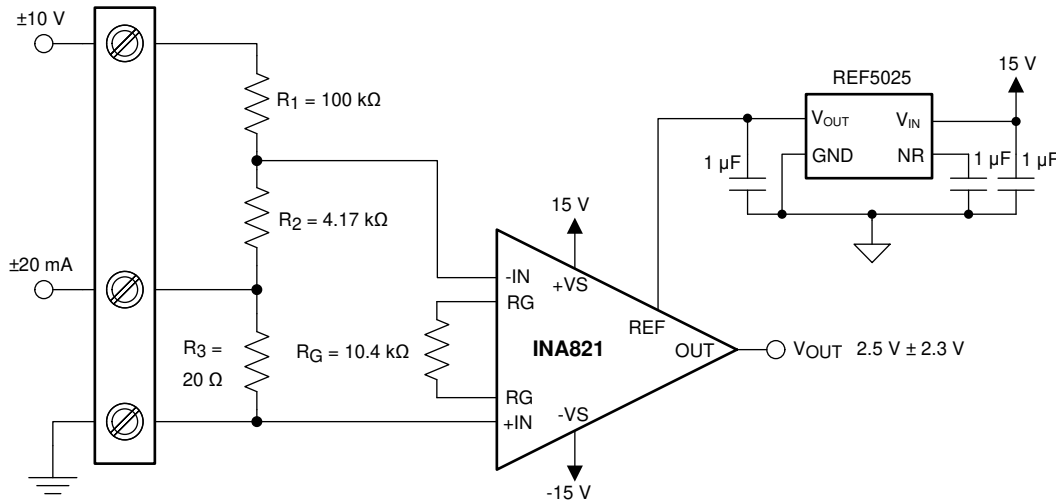

Copyright © 2017, Texas Instruments Incorporated

Figure 69. PLC Input (± 10 V, 4 mA to 20 mA)

9.2.1 Design Requirements

For this application, the design requirements are as follows:

- 4-mA to 20-mA input with less than 20- Ω burden
- ± 20 -mA input with less than 20- Ω burden
- ± 10 -V input with impedance of approximately 100 k Ω
- Maximum 4-mA to 20-mA or ± 20 mA burden voltage equal to ± 0.4 V
- Output range within 0 V to 5 V

9.2.2 Detailed Design Procedure

There are two modes of operation for the circuit shown in Figure 69: current input and voltage input. This design requires $R_1 \gg R_2 \gg R_3$. Given this relationship, Equation 3 calculates the current input mode transfer function.

$$V_{\text{OUT-I}} = V_D \times G + V_{\text{REF}} = -(I_{\text{IN}} \times R_3) \times G + V_{\text{REF}}$$

where

- G represents the gain of the instrumentation amplifier.
- V_D represents the differential voltage at the INA821 inputs.
- V_{REF} is the voltage at the INA821 REF pin.
- I_{IN} is the input current.

(3)

Equation 4 shows the transfer function for the voltage input mode.

$$V_{\text{OUT-V}} = V_D \times G + V_{\text{REF}} = -\left[V_{\text{IN}} \times \frac{R_2}{R_1 + R_2} \right] \times G + V_{\text{REF}}$$

where

- V_{IN} is the input voltage

(4)

Typical Application (continued)

R_1 sets the input impedance of the voltage input mode. The minimum typical input impedance is 100 k Ω . The R_1 value is 100 k Ω because increasing the R_1 value also increases noise. The value of R_3 must be extremely small compared to R_1 and R_2 . The value of R_3 is 20 Ω because that resistance value is smaller than R_1 and yields an input voltage of ± 400 mV when operating in current mode (± 20 mA).

Use Equation 5 to calculate R_2 if $V_D = \pm 400$ mV, $V_{IN} = \pm 10$ V, and $R_1 = 100$ k Ω .

$$V_D = V_{IN} \times \frac{R_2}{R_1 + R_2} \rightarrow R_2 = \frac{R_1 \times V_D}{V_{IN} - V_D} = 4.167 \text{ k}\Omega \quad (5)$$

The value obtained from Equation 5 is not a standard 0.1% value, so 4.17 k Ω is selected. R_1 and R_2 use 0.1% tolerance resistors to minimize error.

Use Equation 6 to calculate the gain of the instrumentation amplifier.

$$G = \frac{V_{OUT} - V_{REF}}{V_D} = \frac{4.8 \text{ V} - 2.5 \text{ V}}{400 \text{ mV}} = 5.75 \frac{\text{V}}{\text{V}} \quad (6)$$

Equation 7 calculates the gain-setting resistor value using the INA821 gain equation (Equation 1).

$$R_G = \frac{49.4 \text{ k}\Omega}{G - 1} = \frac{49.4 \text{ k}\Omega}{5.75 - 1} = 10.4 \text{ k}\Omega \quad (7)$$

Use a standard 0.1% resistor value of 10.5 k Ω for this design.

9.2.3 Application Curves

Figure 70 and Figure 71 show typical characteristic curves for the circuit in Figure 69.

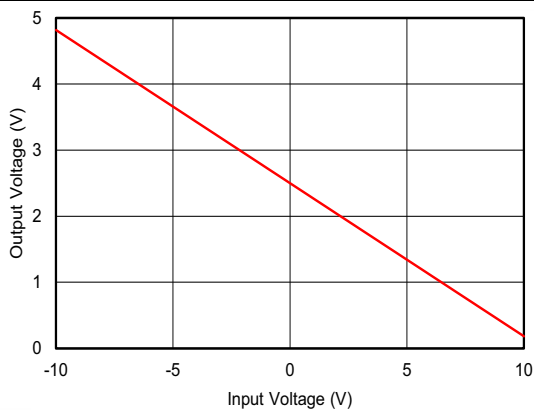

Figure 70. PLC Output Voltage vs Input Voltage

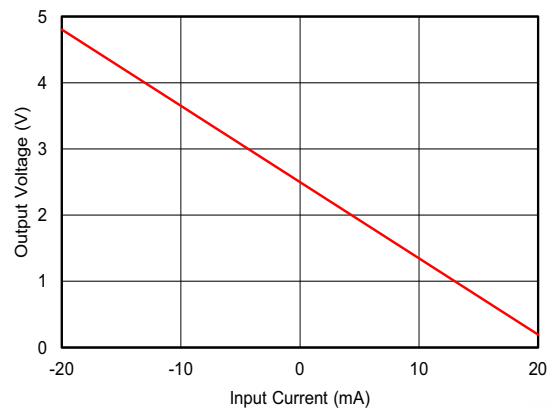
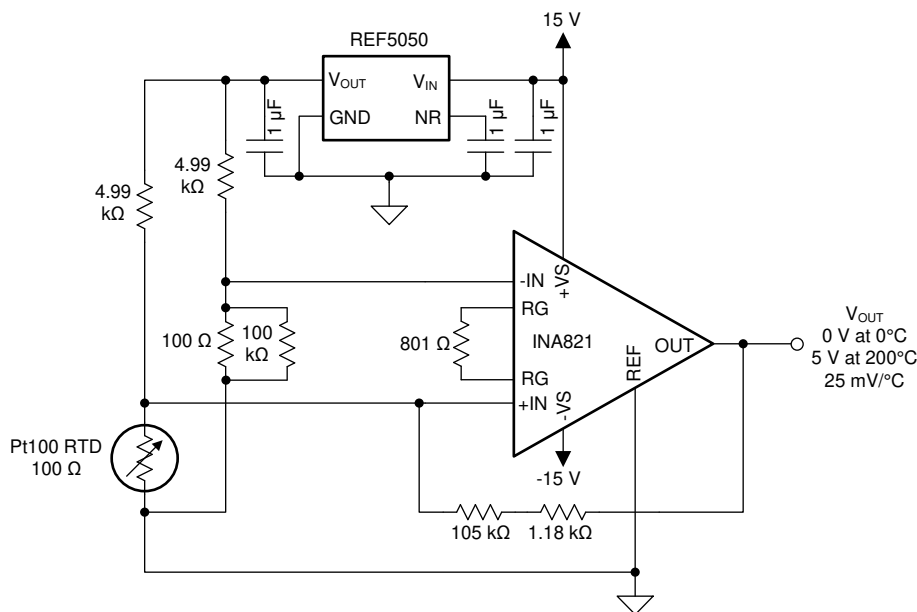

Figure 71. PLC Output Voltage vs Input Current

9.3 Other Application Examples

9.3.1 Resistance Temperature Detector Interface

Figure 72 illustrates a 3-wire interface circuit for resistance temperature detectors (RTDs). The circuit incorporates analog linearization and has an output voltage range from 0 V to 5 V. The linearization technique employed is described in *Analog linearization of resistance temperature detectors analog application journal*. Series and parallel combinations of standard 1% resistor values are used to achieve less than 0.02°C of error over a 200°C temperature span.



Copyright © 2017, Texas Instruments Incorporated

Figure 72. A 3-Wire Interface for RTDs With Analog Linearization

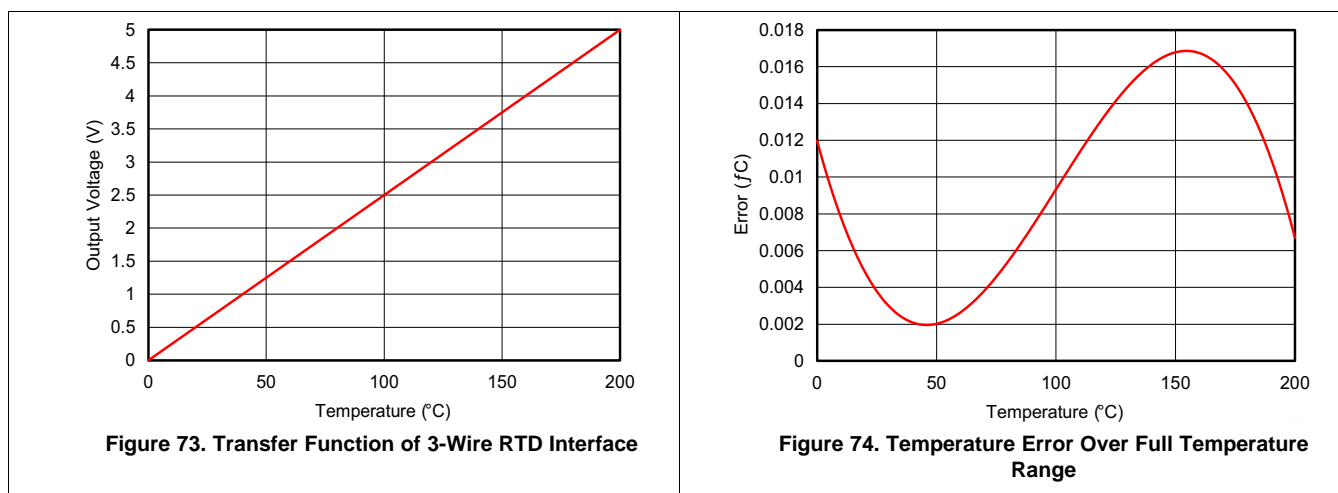

10 Power Supply Recommendations

The nominal performance of the INA821 is specified with a supply voltage of ± 15 V and midsupply reference voltage. The device also operates using power supplies from ± 2.25 V (4.5 V) to ± 18 V (36 V) and non-midsupply reference voltages with excellent performance. Parameters that can vary significantly with operating voltage and reference voltage are shown in the [Typical Characteristics](#) section.

11 Layout

11.1 Layout Guidelines

Attention to good layout practices is always recommended. For best operational performance of the device, use good PCB layout practices, including:

- Make sure that both input paths are well-matched for source impedance and capacitance to avoid converting common-mode signals into differential signals. Even slight mismatch in parasitic capacitance at the gain setting pins can degrade CMRR over frequency. For example, in applications that implement gain switching using switches or PhotoMOS[®] relays to change the value of R_G , select the component so that the switch capacitance is as small as possible and most importantly so that capacitance mismatch between the R_G pins is minimized.
- Noise propagates into analog circuitry through the power pins of the circuit as a whole and of the device. Bypass capacitors reduce the coupled noise by providing low-impedance power sources local to the analog circuitry.
 - Connect low-ESR, 0.1- μ F ceramic bypass capacitors between each supply pin and ground, placed as close to the device as possible. A single bypass capacitor from $V+$ to ground is applicable for single-supply applications.
- To reduce parasitic coupling, run the input traces as far away from the supply or output traces as possible. If these traces cannot be kept separate, crossing the sensitive trace perpendicular is much better than in parallel with the noisy trace.
- Place the external components as close to the device as possible. As shown in [Figure 75](#), keep R_G close to the pins to minimize parasitic capacitance.
- Keep the traces as short as possible.
- Connect exposed thermal pad to negative supply $-V$.

11.2 Layout Example

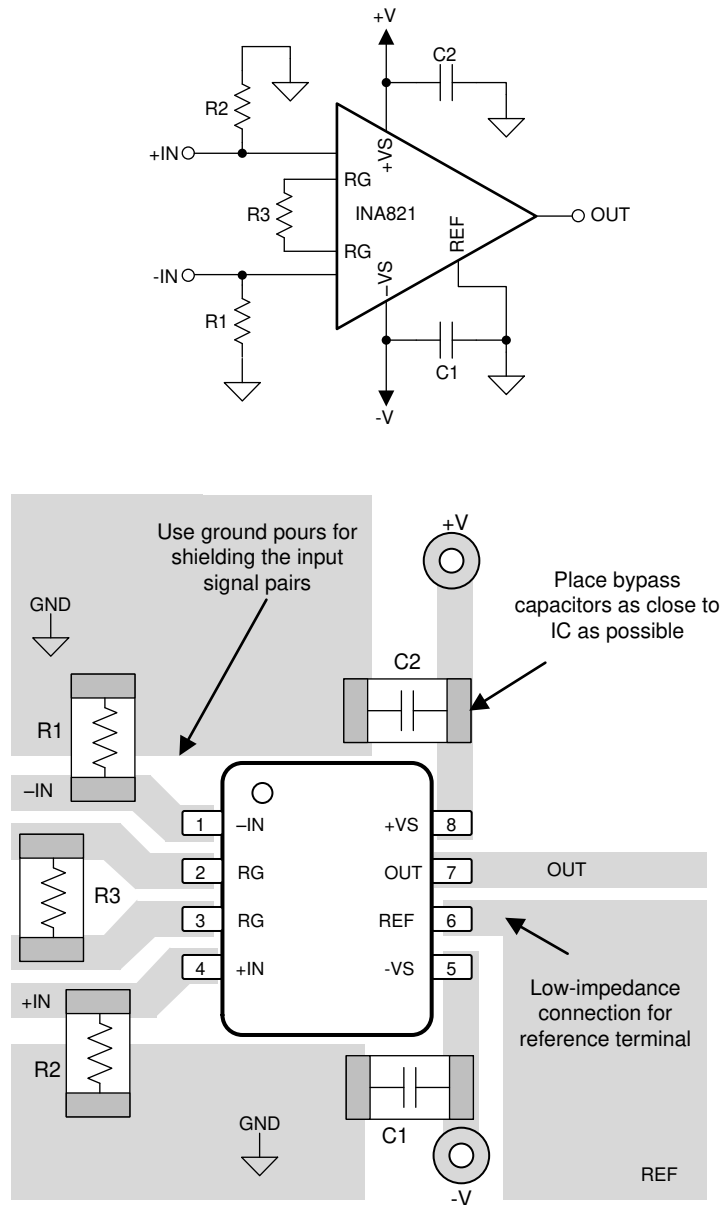

Copyright © 2017, Texas Instruments Incorporated

Figure 75. Example Schematic and Associated PCB Layout

12 Device and Documentation Support

12.1 Device Support

12.1.1 Development Support

- [SPICE-based analog simulation program — TINA-TI software folder](#)
- [Common-Mode Input Range Calculator for Instrumentation Amplifiers](#)

12.2 Documentation Support

12.2.1 Related Documentation

For related documentation see the following:

- Texas Instruments, [Comprehensive Error Calculation for Instrumentation Amplifiers application note](#)
- Texas Instruments, [REF50xx Low-Noise, Very Low Drift, Precision Voltage Reference data sheet](#)
- Texas Instruments, [OPAx191 36-V, Low Power, Precision, CMOS, Rail-to-Rail Input/Output, Low Offset Voltage, Low Input Bias Current Op Amp data sheet](#)

12.3 Receiving Notification of Documentation Updates

To receive notification of documentation updates, navigate to the device product folder on ti.com. In the upper right corner, click on *Alert me* to register and receive a weekly digest of any product information that has changed. For change details, review the revision history included in any revised document.

12.4 Support Resources

TI E2E™ [support forums](#) are an engineer's go-to source for fast, verified answers and design help — straight from the experts. Search existing answers or ask your own question to get the quick design help you need.

Linked content is provided "AS IS" by the respective contributors. They do not constitute TI specifications and do not necessarily reflect TI's views; see TI's [Terms of Use](#).

12.5 Trademarks

E2E is a trademark of Texas Instruments.

Bluetooth is a registered trademark of Bluetooth SIG, Inc.

PhotoMOS is a registered trademark of Panasonic Electric Works Europe AG.

All other trademarks are the property of their respective owners.

12.6 Electrostatic Discharge Caution



This integrated circuit can be damaged by ESD. Texas Instruments recommends that all integrated circuits be handled with appropriate precautions. Failure to observe proper handling and installation procedures can cause damage.

ESD damage can range from subtle performance degradation to complete device failure. Precision integrated circuits may be more susceptible to damage because very small parametric changes could cause the device not to meet its published specifications.

12.7 Glossary

[SLYZ022](#) — *TI Glossary*.

This glossary lists and explains terms, acronyms, and definitions.

13 Mechanical, Packaging, and Orderable Information

The following pages include mechanical, packaging, and orderable information. This information is the most current data available for the designated devices. This data is subject to change without notice and revision of this document. For browser-based versions of this data sheet, refer to the left-hand navigation.

PACKAGING INFORMATION

Orderable part number	Status (1)	Material type (2)	Package Pins	Package qty Carrier	RoHS (3)	Lead finish/ Ball material (4)	MSL rating/ Peak reflow (5)	Op temp (°C)	Part marking (6)
INA821ID	Active	Production	SOIC (D) 8	75 TUBE	Yes	NIPDAU	Level-2-260C-1 YEAR	-40 to 125	INA821
INA821ID.B	Active	Production	SOIC (D) 8	75 TUBE	Yes	NIPDAU	Level-2-260C-1 YEAR	-40 to 125	INA821
INA821IDGKR	Active	Production	VSSOP (DGK) 8	2500 LARGE T&R	Yes	NIPDAU SN NIPDAUAG	Level-2-260C-1 YEAR	-40 to 125	1X4Q
INA821IDGKR.B	Active	Production	VSSOP (DGK) 8	2500 LARGE T&R	Yes	NIPDAU	Level-2-260C-1 YEAR	-40 to 125	1X4Q
INA821IDGKT	Active	Production	VSSOP (DGK) 8	250 SMALL T&R	Yes	NIPDAU SN NIPDAUAG	Level-2-260C-1 YEAR	-40 to 125	1X4Q
INA821IDGKT.B	Active	Production	VSSOP (DGK) 8	250 SMALL T&R	Yes	NIPDAU	Level-2-260C-1 YEAR	-40 to 125	1X4Q
INA821IDR	Active	Production	SOIC (D) 8	2500 LARGE T&R	Yes	NIPDAU	Level-2-260C-1 YEAR	-40 to 125	INA821
INA821IDR.B	Active	Production	SOIC (D) 8	2500 LARGE T&R	Yes	NIPDAU	Level-2-260C-1 YEAR	-40 to 125	INA821
INA821IDRG4	Active	Production	SOIC (D) 8	2500 LARGE T&R	Yes	NIPDAU	Level-2-260C-1 YEAR	-40 to 125	INA821
INA821IDRG4.B	Active	Production	SOIC (D) 8	2500 LARGE T&R	Yes	NIPDAU	Level-2-260C-1 YEAR	-40 to 125	INA821
INA821IDRGR	Active	Production	SON (DRG) 8	3000 LARGE T&R	Yes	NIPDAU	Level-1-260C-UNLIM	-40 to 125	INA821
INA821IDRGR.B	Active	Production	SON (DRG) 8	3000 LARGE T&R	Yes	NIPDAU	Level-1-260C-UNLIM	-40 to 125	INA821
INA821IDRGT	Active	Production	SON (DRG) 8	250 SMALL T&R	Yes	NIPDAU	Level-1-260C-UNLIM	-40 to 125	INA821
INA821IDRGT.B	Active	Production	SON (DRG) 8	250 SMALL T&R	Yes	NIPDAU	Level-1-260C-UNLIM	-40 to 125	INA821

(1) **Status:** For more details on status, see our [product life cycle](#).

(2) **Material type:** When designated, preproduction parts are prototypes/experimental devices, and are not yet approved or released for full production. Testing and final process, including without limitation quality assurance, reliability performance testing, and/or process qualification, may not yet be complete, and this item is subject to further changes or possible discontinuation. If available for ordering, purchases will be subject to an additional waiver at checkout, and are intended for early internal evaluation purposes only. These items are sold without warranties of any kind.

(3) **RoHS values:** Yes, No, RoHS Exempt. See the [TI RoHS Statement](#) for additional information and value definition.

(4) **Lead finish/Ball material:** Parts may have multiple material finish options. Finish options are separated by a vertical ruled line. Lead finish/Ball material values may wrap to two lines if the finish value exceeds the maximum column width.

(5) **MSL rating/Peak reflow:** The moisture sensitivity level ratings and peak solder (reflow) temperatures. In the event that a part has multiple moisture sensitivity ratings, only the lowest level per JEDEC standards is shown. Refer to the shipping label for the actual reflow temperature that will be used to mount the part to the printed circuit board.

(6) Part marking: There may be an additional marking, which relates to the logo, the lot trace code information, or the environmental category of the part.

Multiple part markings will be inside parentheses. Only one part marking contained in parentheses and separated by a "-" will appear on a part. If a line is indented then it is a continuation of the previous line and the two combined represent the entire part marking for that device.

Important Information and Disclaimer:The information provided on this page represents TI's knowledge and belief as of the date that it is provided. TI bases its knowledge and belief on information provided by third parties, and makes no representation or warranty as to the accuracy of such information. Efforts are underway to better integrate information from third parties. TI has taken and continues to take reasonable steps to provide representative and accurate information but may not have conducted destructive testing or chemical analysis on incoming materials and chemicals. TI and TI suppliers consider certain information to be proprietary, and thus CAS numbers and other limited information may not be available for release.

In no event shall TI's liability arising out of such information exceed the total purchase price of the TI part(s) at issue in this document sold by TI to Customer on an annual basis.

TAPE AND REEL INFORMATION

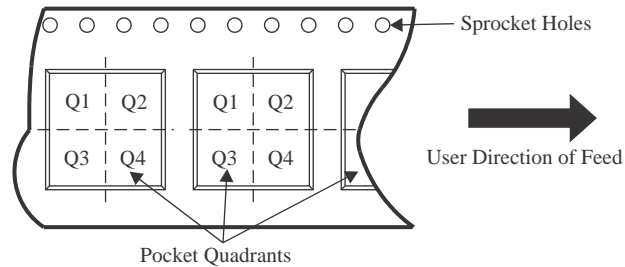
QUADRANT ASSIGNMENTS FOR PIN 1 ORIENTATION IN TAPE

*All dimensions are nominal

Device	Package Type	Package Drawing	Pins	SPQ	Reel Diameter (mm)	Reel Width W1 (mm)	A0 (mm)	B0 (mm)	K0 (mm)	P1 (mm)	W (mm)	Pin1 Quadrant
INA821IDGKR	VSSOP	DGK	8	2500	330.0	12.4	5.25	3.35	1.25	8.0	12.0	Q1
INA821IDGKT	VSSOP	DGK	8	250	330.0	12.4	5.3	3.4	1.4	8.0	12.0	Q1
INA821IDGKT	VSSOP	DGK	8	250	330.0	12.4	5.25	3.35	1.25	8.0	12.0	Q1
INA821IDR	SOIC	D	8	2500	330.0	12.4	6.4	5.2	2.1	8.0	12.0	Q1
INA821IDRG4	SOIC	D	8	2500	330.0	12.4	6.4	5.2	2.1	8.0	12.0	Q1
INA821IDRGR	SON	DRG	8	3000	330.0	12.4	3.3	3.3	1.1	8.0	12.0	Q2
INA821IDRG4	SON	DRG	8	250	180.0	12.4	3.3	3.3	1.1	8.0	12.0	Q2

TAPE AND REEL BOX DIMENSIONS



*All dimensions are nominal

Device	Package Type	Package Drawing	Pins	SPQ	Length (mm)	Width (mm)	Height (mm)
INA821IDGKR	VSSOP	DGK	8	2500	366.0	364.0	50.0
INA821IDGKT	VSSOP	DGK	8	250	353.0	353.0	32.0
INA821IDGKT	VSSOP	DGK	8	250	366.0	364.0	50.0
INA821IDR	SOIC	D	8	2500	353.0	353.0	32.0
INA821IDRG4	SOIC	D	8	2500	353.0	353.0	32.0
INA821IDRGR	SON	DRG	8	3000	367.0	367.0	35.0
INA821IDRGT	SON	DRG	8	250	210.0	185.0	35.0

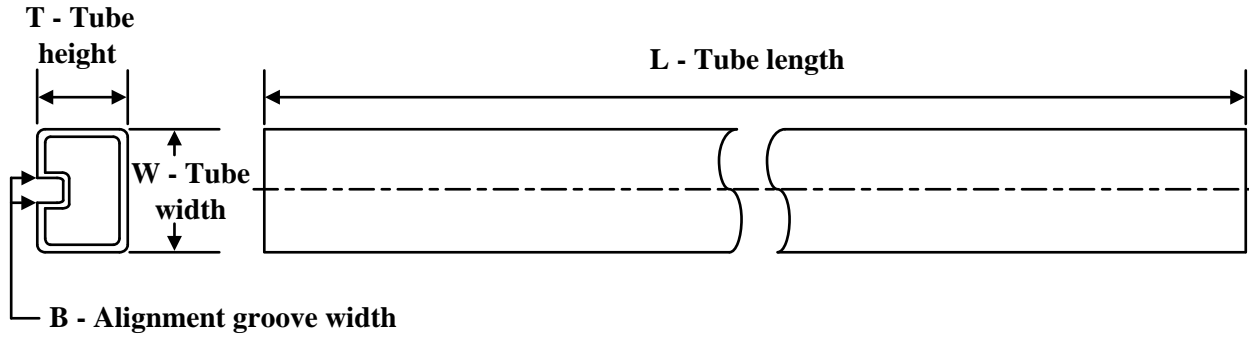
TUBE

*All dimensions are nominal

Device	Package Name	Package Type	Pins	SPQ	L (mm)	W (mm)	T (μm)	B (mm)
INA821ID	D	SOIC	8	75	506.6	8	3940	4.32
INA821ID.B	D	SOIC	8	75	506.6	8	3940	4.32

DGK0008A



PACKAGE OUTLINE

VSSOP - 1.1 mm max height

SMALL OUTLINE PACKAGE



4214862/A 04/2023

NOTES:

PowerPAD is a trademark of Texas Instruments.

1. All linear dimensions are in millimeters. Any dimensions in parenthesis are for reference only. Dimensioning and tolerancing per ASME Y14.5M.
2. This drawing is subject to change without notice.
3. This dimension does not include mold flash, protrusions, or gate burrs. Mold flash, protrusions, or gate burrs shall not exceed 0.15 mm per side.
4. This dimension does not include interlead flash. Interlead flash shall not exceed 0.25 mm per side.
5. Reference JEDEC registration MO-187.

EXAMPLE BOARD LAYOUT

DGK0008A

™ VSSOP - 1.1 mm max height

SMALL OUTLINE PACKAGE



LAND PATTERN EXAMPLE
EXPOSED METAL SHOWN
SCALE: 15X



SOLDER MASK DETAILS

4214862/A 04/2023

NOTES: (continued)

6. Publication IPC-7351 may have alternate designs.
7. Solder mask tolerances between and around signal pads can vary based on board fabrication site.
8. Vias are optional depending on application, refer to device data sheet. If any vias are implemented, refer to their locations shown on this view. It is recommended that vias under paste be filled, plugged or tented.
9. Size of metal pad may vary due to creepage requirement.

EXAMPLE STENCIL DESIGN

DGK0008A

TM VSSOP - 1.1 mm max height

SMALL OUTLINE PACKAGE



SOLDER PASTE EXAMPLE
SCALE: 15X

4214862/A 04/2023

NOTES: (continued)

11. Laser cutting apertures with trapezoidal walls and rounded corners may offer better paste release. IPC-7525 may have alternate design recommendations.
12. Board assembly site may have different recommendations for stencil design.

GENERIC PACKAGE VIEW

DRG 8

WSO - 0.8 mm max height

3 x 3, 0.5 mm pitch

PLASTIC SMALL OUTLINE - NO LEAD

This image is a representation of the package family, actual package may vary.
Refer to the product data sheet for package details.

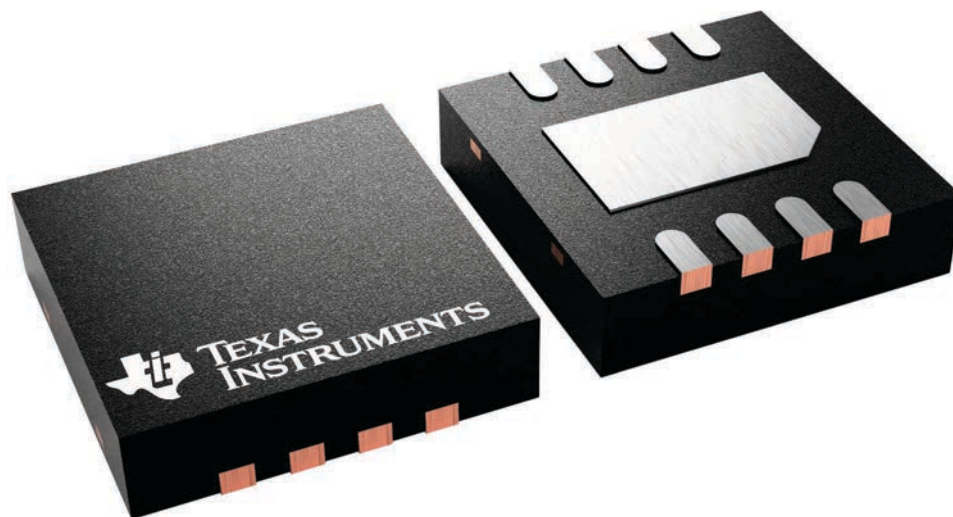

4225794/A

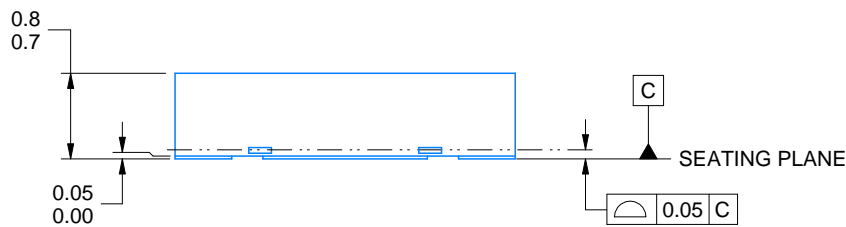
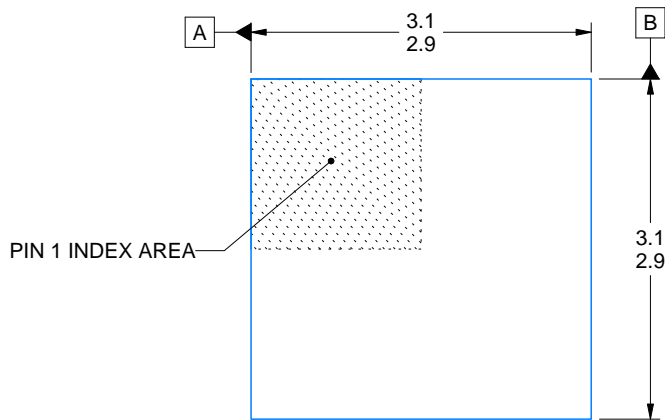
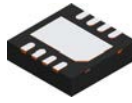

DIMENSION A	
OPTION 01	(0.1)
OPTION 02	(0.2)

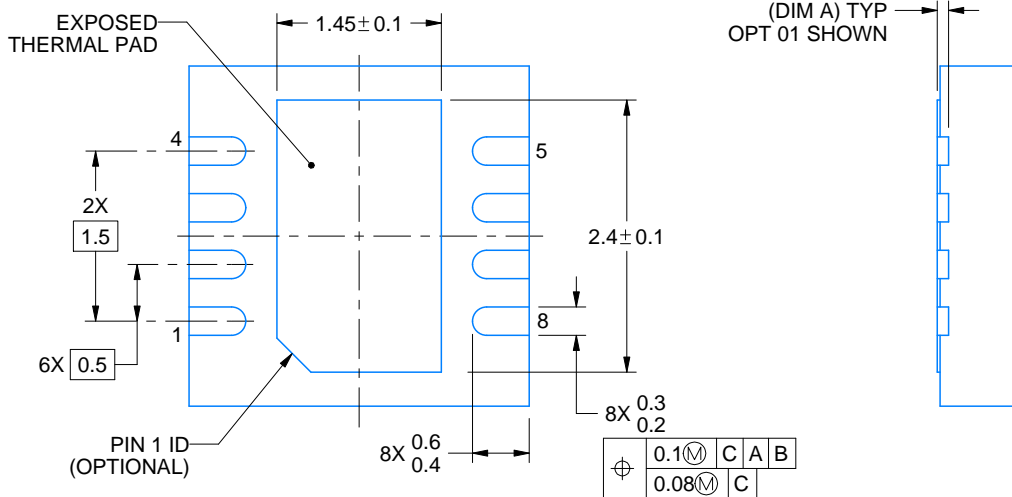

4218886/A 01/2020

NOTES:

1. All linear dimensions are in millimeters. Any dimensions in parenthesis are for reference only. Dimensioning and tolerancing per ASME Y14.5M.
2. This drawing is subject to change without notice.
3. The package thermal pad must be soldered to the printed circuit board for thermal and mechanical performance.

EXAMPLE STENCIL DESIGN

DRG0008B

WSO - 0.8 mm max height

PLASTIC SMALL OUTLINE - NO LEAD

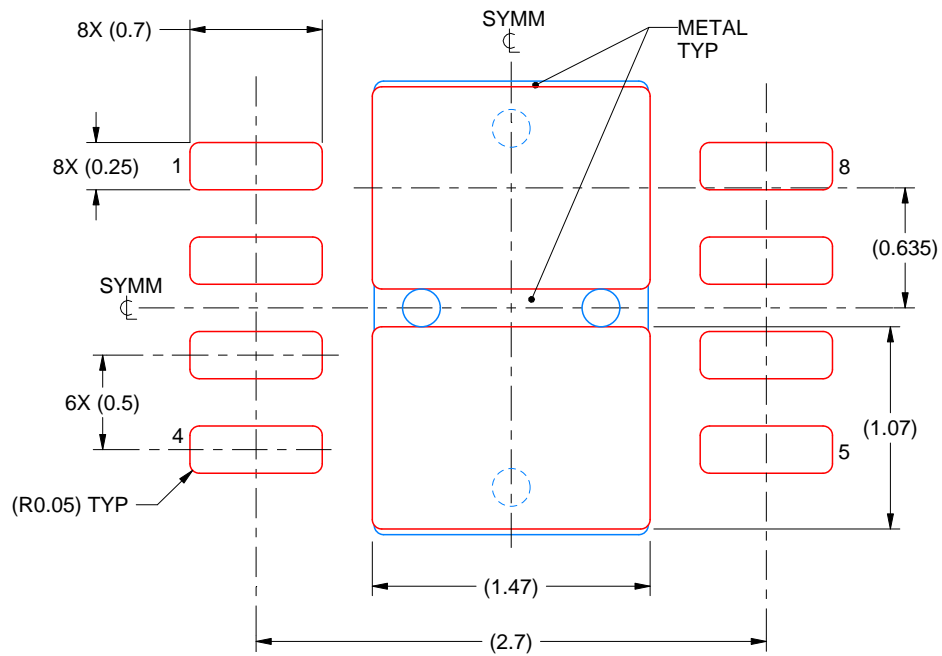

SOLDER PASTE EXAMPLE
BASED ON 0.125 mm THICK STENCIL

EXPOSED PAD
82% PRINTED SOLDER COVERAGE BY AREA
SCALE:25X

4218886/A 01/2020

NOTES: (continued)

6. Laser cutting apertures with trapezoidal walls and rounded corners may offer better paste release. IPC-7525 may have alternate design recommendations.



D0008A

PACKAGE OUTLINE

SOIC - 1.75 mm max height

SMALL OUTLINE INTEGRATED CIRCUIT



4214825/C 02/2019

NOTES:

1. Linear dimensions are in inches [millimeters]. Dimensions in parenthesis are for reference only. Controlling dimensions are in inches. Dimensioning and tolerancing per ASME Y14.5M.
2. This drawing is subject to change without notice.
3. This dimension does not include mold flash, protrusions, or gate burrs. Mold flash, protrusions, or gate burrs shall not exceed $.006$ [0.15] per side.
4. This dimension does not include interlead flash.
5. Reference JEDEC registration MS-012, variation AA.

EXAMPLE BOARD LAYOUT

D0008A

SOIC - 1.75 mm max height

SMALL OUTLINE INTEGRATED CIRCUIT



LAND PATTERN EXAMPLE
 EXPOSED METAL SHOWN
 SCALE:8X



SOLDER MASK DETAILS

4214825/C 02/2019

NOTES: (continued)

- 6. Publication IPC-7351 may have alternate designs.
- 7. Solder mask tolerances between and around signal pads can vary based on board fabrication site.

EXAMPLE STENCIL DESIGN

D0008A

SOIC - 1.75 mm max height

SMALL OUTLINE INTEGRATED CIRCUIT



SOLDER PASTE EXAMPLE
BASED ON .005 INCH [0.125 MM] THICK STENCIL
SCALE:8X

4214825/C 02/2019

NOTES: (continued)

8. Laser cutting apertures with trapezoidal walls and rounded corners may offer better paste release. IPC-7525 may have alternate design recommendations.
9. Board assembly site may have different recommendations for stencil design.

IMPORTANT NOTICE AND DISCLAIMER

TI PROVIDES TECHNICAL AND RELIABILITY DATA (INCLUDING DATASHEETS), DESIGN RESOURCES (INCLUDING REFERENCE DESIGNS), APPLICATION OR OTHER DESIGN ADVICE, WEB TOOLS, SAFETY INFORMATION, AND OTHER RESOURCES "AS IS" AND WITH ALL FAULTS, AND DISCLAIMS ALL WARRANTIES, EXPRESS AND IMPLIED, INCLUDING WITHOUT LIMITATION ANY IMPLIED WARRANTIES OF MERCHANTABILITY, FITNESS FOR A PARTICULAR PURPOSE OR NON-INFRINGEMENT OF THIRD PARTY INTELLECTUAL PROPERTY RIGHTS.

These resources are intended for skilled developers designing with TI products. You are solely responsible for (1) selecting the appropriate TI products for your application, (2) designing, validating and testing your application, and (3) ensuring your application meets applicable standards, and any other safety, security, regulatory or other requirements.

These resources are subject to change without notice. TI grants you permission to use these resources only for development of an application that uses the TI products described in the resource. Other reproduction and display of these resources is prohibited. No license is granted to any other TI intellectual property right or to any third party intellectual property right. TI disclaims responsibility for, and you fully indemnify TI and its representatives against any claims, damages, costs, losses, and liabilities arising out of your use of these resources.

TI's products are provided subject to [TI's Terms of Sale](#), [TI's General Quality Guidelines](#), or other applicable terms available either on [ti.com](#) or provided in conjunction with such TI products. TI's provision of these resources does not expand or otherwise alter TI's applicable warranties or warranty disclaimers for TI products. Unless TI explicitly designates a product as custom or customer-specified, TI products are standard, catalog, general purpose devices.

TI objects to and rejects any additional or different terms you may propose.

Copyright © 2026, Texas Instruments Incorporated

Last updated 10/2025