

## LMV112 40 MHz Dual Clock Buffer

Check for Samples: [LMV112](#)

### FEATURES

- (Typical Values are:  $V_{\text{SUPPLY}} = 2.7\text{V}$  and  $C_L = 20\text{ pF}$ , Unless Otherwise Specified.)
- Small Signal Bandwidth 40 MHz
- Supply Voltage Range 2.4V to 5V
- Slew Rate 110 V/ $\mu\text{s}$
- Total Supply Current 1.6 mA
- Shutdown Current 59  $\mu\text{A}$
- Rail-to-Rail Input and Output
- Individual Buffer Enable Pins
- Rapid  $T_{\text{on}}$  Technology
- Crosstalk Rejection Circuitry
- 8-pin WSON, Pin Access Packaging
- Temperature Range  $-40^\circ\text{C}$  to  $85^\circ\text{C}$

### APPLICATIONS

- 3G Mobile Applications
- WLAN-WiMAX Modules
- TD\_SCDMA Multi-Mode MP3 and Camera
- GSM Modules
- Oscillator Modules

### DESCRIPTION

The LMV112 is a high speed dual clock buffer designed for portable communications and accurate multi-clock systems. The LMV112 integrates two 40 MHz low noise buffers which optimizes application and out performs large discrete solutions. This device enables superb system operation between the base band and the oscillator signal path while eliminating crosstalk.

Texas Instruments' unique technology and design deliver accuracy, capacitance and load resistance while increasing the drive capability of the device. The low power consumption makes the LMV112 perfect for battery applications.

The robust, independent, and flexible buffers are designed to provide the customer with the ability to manage complex clock signals in the latest wireless applications. The buffers deliver 110 V/ $\mu\text{s}$  internal slew rate with independent shutdown and duty cycle precision. The patented analog circuit drives capacitive loads beyond 20 pF. Texas Instruments' proven biasing technique has 1V centering, rail-to-rail input/output unity gain, and AC coupled convenient inputs. These integrated cells save space and require no external bias resistors. Texas Instruments' rapid recovery after disable optimizes performance and current consumption. The LMV112 offers individual enable pin controls and since there is no internal ground reference either single or split supply configurations offer additional system flexibility and power choices.

The LMV112 is a proven replacement for any discrete circuitry and simplifies board layout while minimizing related parasitic components.

The LMV112 is produced in the small WSON package which offers high quality while minimizing its use of PCB space. Texas Instruments' advanced packaging offers direct PCB-IC evaluation via pin access.



Please be aware that an important notice concerning availability, standard warranty, and use in critical applications of Texas Instruments semiconductor products and disclaimers thereto appears at the end of this data sheet.

All trademarks are the property of their respective owners.

## TYPICAL APPLICATION

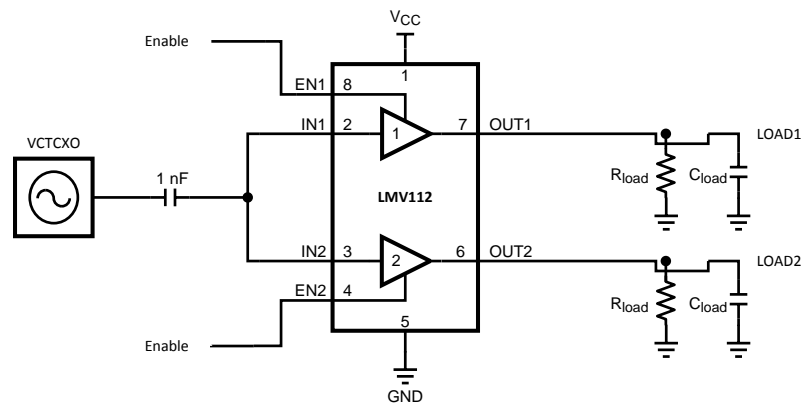

Figure 1.



These devices have limited built-in ESD protection. The leads should be shorted together or the device placed in conductive foam during storage or handling to prevent electrostatic damage to the MOS gates.

### ABSOLUTE MAXIMUM RATINGS<sup>(1)(2)</sup>

|                                     |                 |
|-------------------------------------|-----------------|
| Supply Voltages ( $V^+ - V^-$ )     | 5.5V            |
| ESD Tolerance <sup>(3)</sup>        |                 |
| Human Body                          | 2000V           |
| Machine Model                       | 200V            |
| Storage Temperature Range           | -65°C to +150°C |
| Junction Temperature <sup>(4)</sup> | +150°C          |
| Soldering Information               |                 |
| Infrared or Convection (35 sec.)    | 235°C           |

- (1) Absolute Maximum Ratings indicate limits beyond which damage to the device may occur. Operating Ratings indicate conditions for which the device is intended to be functional, but specific performance is not ensured. For specifications and the test conditions, see the Electrical Characteristics Tables.
- (2) If Military/Aerospace specified devices are required, please contact the Texas Instruments Sales Office/ Distributors for availability and specifications.
- (3) Human Body Model: 1.5 k $\Omega$  in series with 100 pF. Machine Model: 0 $\Omega$  in series with 200 pF.
- (4) The maximum power dissipation is a function of  $T_{J(MAX)}$ ,  $\theta_{JA}$ , and  $T_A$ . The maximum allowable power dissipation at any ambient temperature is  $P_D = (T_{J(MAX)} - T_A) / \theta_{JA}$ . All numbers apply for packages soldered directly onto a PC board.

### OPERATING RATINGS<sup>(1)</sup>

|   |                |
|---|----------------|
| Supply Voltage ( $V^+ - V^-$ )                | 2.4V to 5.0V   |
| Temperature Range <sup>(2) (3)</sup>          | -40°C to +85°C |
| Package Thermal Resistance <sup>(2) (3)</sup> |                |
| WSON-8 ( $\theta_{JA}$ )                      | 217°C/W        |

- (1) Absolute Maximum Ratings indicate limits beyond which damage to the device may occur. Operating Ratings indicate conditions for which the device is intended to be functional, but specific performance is not ensured. For specifications and the test conditions, see the Electrical Characteristics Tables.
- (2) The maximum power dissipation is a function of  $T_{J(MAX)}$ ,  $\theta_{JA}$ , and  $T_A$ . The maximum allowable power dissipation at any ambient temperature is  $P_D = (T_{J(MAX)} - T_A) / \theta_{JA}$ . All numbers apply for packages soldered directly onto a PC board.
- (3) Electrical Table values apply only for factory testing conditions at the temperature indicated. Factory testing conditions result in very limited self-heating of the device such that  $T_J = T_A$ .

## 2.7V ELECTRICAL CHARACTERISTICS

Unless otherwise specified, all limits are specified for  $T_J = 25^\circ\text{C}$ ,  $V_{DD} = 2.7\text{V}$ ,  $V_{SS} = 0\text{V}$ ,  $V_{CM} = 1\text{V}$ ,  $\text{Enable}_{1,2} = V_{DD}$ ,  $C_L = 20\text{ pF}$ ,  $R_L = 30\text{ k}\Omega$ ,  $C_{COUPLING} = 1\text{ nF}$ . **Boldface** limits apply at temperature range extremes of operating condition. See <sup>(1)</sup>.

| Symbol                                  | Parameter  | Conditions                                     | Min <sup>(2)</sup>  | Typ <sup>(3)</sup> | Max <sup>(2)</sup>  | Units                        |
|---|--|--|---------------------|--------------------|---------------------|------------------------------|
| <b>Frequency Domain Response</b>        |  |  |                     |                    |                     |                              |
| SSBW                                    | Small Signal Bandwidth                                       | $V_{IN} = 0.63 V_{PP}$ ; -3 dB                 |                     | 40                 |                     | MHz                          |
| FPBW                                    | Full Power Bandwidth   | $V_{IN} = 1.6 V_{PP}$ ; -3 dB                  |                     | 28                 |                     | MHz                          |
| GFN                                     | Gain Flatness < 0.1 dB                                       | $f > 100\text{ kHz}$                           |                     | 3.4                |                     | MHz                          |
| <b>Distortion and Noise Performance</b> |  |  |                     |                    |                     |                              |
| $e_n$                                   | Input-Referred Voltage Noise                                 | $f = 1\text{ MHz}$                             |                     | 26                 |                     | nV/ $\sqrt{\text{Hz}}$       |
| $I_{\text{ISOLATION}}$                  | Output to Input  | $f = 1\text{ MHz}$                             |                     | 91                 |                     | dB                           |
| CT                                      | Crosstalk Rejection  | $f = 26\text{ MHz}$ , $P_{IN} = 0\text{ dBm}$  |                     | 54                 |                     | dB                           |
| <b>Time Domain Response</b>             |  |  |                     |                    |                     |                              |
| $t_r$                                   | Rise Time  | 0.1 $V_{PP}$ Step (10-90%), $f = 1\text{ MHz}$ |                     | 7                  |                     | ns                           |
| $t_f$                                   | Fall Time  |  |                     | 6                  |                     | ns                           |
| $t_s$                                   | Settling Time to 0.1%  | 1 $V_{PP}$ Step, $f = 1\text{ MHz}$            |                     | 118                |                     | ns                           |
| OS                                      | Overshoot  | 0.1 $V_{PP}$ Step, $f = 1\text{ MHz}$          |                     | 41                 |                     | %                            |
| SR                                      | Slew Rate <sup>(4)</sup>                                     | $V_{IN} = 1.6 V_{PP}$ , $f = 26\text{ MHz}$    |                     | 110                |                     | V/ $\mu\text{s}$             |
| <b>Static DC Performance</b>            |  |  |                     |                    |                     |                              |
| $I_S$                                   | Supply Current   | $\text{Enable}_{1,2} = V_{DD}$ ; No Load       |                     | 1.6                | 2.0<br><b>2.1</b>   | mA                           |
|   |  | $\text{Enable}_{1,2} = V_{SS}$ ; No Load       |                     | 59                 | 72<br><b>78</b>     | $\mu\text{A}$                |
| PSRR                                    | Power Supply Rejection Ratio                                 | DC (3.0V to 5.0V)                              | 58<br><b>57</b>     | 68                 |                     | dB                           |
| $A_{CL}$                                | Small Signal Voltage Gain                                    | $V_{OUT} = 0.1 V_{PP}$                         | 0.97<br><b>0.95</b> | 1.01               | 1.05<br><b>1.07</b> | V/V                          |
| $V_{OS}$                                | Output Offset Voltage  |  |                     | 0.4                | 16<br><b>17</b>     | mV                           |
| TC $V_{OS}$                             | Temperature Coefficient Output Offset Voltage <sup>(5)</sup> |  |                     | 4                  |                     | $\mu\text{V}/^\circ\text{C}$ |
| $R_{OUT}$                               | Output Resistance  | $f = 100\text{ kHz}$                           |                     | 0.5                |                     | $\Omega$                     |
|   |  | $f = 26\text{ MHz}$                            |                     | 140                |                     |                              |
| <b>Miscellaneous Performance</b>        |  |  |                     |                    |                     |                              |
| $R_{IN}$                                | Input Resistance per Buffer                                  | $\text{Enable} = V_{DD}$                       |                     | 141                |                     | k $\Omega$                   |
|   |  | $\text{Enable} = V_{SS}$                       |                     | 141                |                     |                              |
| $C_{IN}$                                | Input Capacitance per Buffer                                 | $\text{Enable} = V_{DD}$                       |                     | 2.3                |                     | pF                           |
|   |  | $\text{Enable} = V_{SS}$                       |                     | 2.3                |                     |                              |
| $Z_{IN}$                                | Input Impedance  | $f = 26\text{ MHz}$ , $\text{Enable} = V_{DD}$ |                     | 10.4               |                     | k $\Omega$                   |
|   |  | $f = 26\text{ MHz}$ , $\text{Enable} = V_{SS}$ |                     | 10.9               |                     |                              |
| $V_O$                                   | Output Swing Positive  | $V_{IN} = V_{DD}$                              | 2.65<br><b>2.63</b> | 2.69               |                     | V                            |
|   | Output Swing Negative  | $V_{IN} = V_{SS}$                              |                     | 10                 | 50<br><b>65</b>     | mV                           |

- (1) Electrical Table values apply only for factory testing conditions at the temperature indicated. Factory testing conditions result in very limited self-heating of the device such that  $T_J = T_A$ .
- (2) All limits are specified by testing or statistical analysis.
- (3) Typical Values represent the most likely parametric norm.
- (4) Slew rate is the average of the positive and negative slew rate.
- (5) Average Temperature Coefficient is determined by dividing the changing in a parameter at temperature extremes by the total temperature change.

## 2.7V ELECTRICAL CHARACTERISTICS (continued)

Unless otherwise specified, all limits are specified for  $T_J = 25^\circ\text{C}$ ,  $V_{DD} = 2.7\text{V}$ ,  $V_{SS} = 0\text{V}$ ,  $V_{CM} = 1\text{V}$ ,  $\text{Enable}_{1,2} = V_{DD}$ ,  $C_L = 20\text{ pF}$ ,  $R_L = 30\text{ k}\Omega$ ,  $C_{COUPLING} = 1\text{ nF}$ . **Boldface** limits apply at temperature range extremes of operating condition. See <sup>(1)</sup>.

| Symbol         | Parameter                                   | Conditions | Min <sup>(2)</sup> | Typ <sup>(3)</sup> | Max <sup>(2)</sup> | Units |
|----------------|---|------------|--------------------|--------------------|--------------------|-------|
| $I_{SC}$       | Output Short-Circuit Current <sup>(6)</sup> | Sourcing   | -18<br><b>-13</b>  | -27                |                    | mA    |
|                |   | Sinking    | 20<br><b>16</b>    | 30                 |                    |       |
| $V_{en\_hmin}$ | Enable High Active Minimum Voltage          |            |                    | 1.2                |                    | V     |
| $V_{en\_lmax}$ | Enable Low Inactive Maximum Voltage         |            |                    | 0.6                |                    |       |

(6) Short-Circuit test is a momentary test. Continuous short circuit operation at elevated ambient temperature can result in exceeding the maximum allowed junction temperature of  $150^\circ\text{C}$ .

## 5V ELECTRICAL CHARACTERISTICS

Unless otherwise specified, all limits are specified for  $T_J = 25^\circ\text{C}$ ,  $V_{DD} = 5\text{V}$ ,  $V_{SS} = 0\text{V}$ ,  $V_{CM} = 1\text{V}$ ,  $\text{Enable}_{1,2} = V_{DD}$ ,  $C_L = 20\text{ pF}$ ,  $R_L = 30\text{ k}\Omega$ ,  $C_{COUPLING} = 1\text{ nF}$ . **Boldface** limits apply at temperature range extremes of operating condition. See <sup>(1)</sup>.

| Symbol                                  | Parameter  | Conditions                                     | Min <sup>(2)</sup>  | Typ <sup>(3)</sup> | Max <sup>(2)</sup>  | Units                        |
|---|--|--|---------------------|--------------------|---------------------|------------------------------|
| <b>Frequency Domain Response</b>        |  |  |                     |                    |                     |                              |
| SSBW                                    | Small Signal Bandwidth                                       | $V_{IN} = 0.63 V_{PP}$ ; -3 dB                 |                     | 42                 |                     | MHz                          |
| FPBW                                    | Full Power Bandwidth   | $V_{IN} = 1.6 V_{PP}$ ; -3 dB                  |                     | 31                 |                     | MHz                          |
| GFN                                     | Gain Flatness < 0.1 dB                                       | $f > 100\text{ kHz}$                           |                     | 4.9                |                     | MHz                          |
| <b>Distortion and Noise Performance</b> |  |  |                     |                    |                     |                              |
| $e_n$                                   | Input-Referred Voltage Noise                                 | $f = 1\text{ MHz}$                             |                     | 27                 |                     | $\text{nV}/\sqrt{\text{Hz}}$ |
| $I_{SOLATION}$                          | Output to Input  | $f = 1\text{ MHz}$                             |                     | 90                 |                     | dB                           |
| CT                                      | Crosstalk Rejection  | $f = 26\text{ MHz}$ , $P_{IN} = 0\text{ dBm}$  |                     | 61                 |                     | dB                           |
| <b>Time Domain Response</b>             |  |  |                     |                    |                     |                              |
| $t_r$                                   | Rise Time  | 0.1 $V_{PP}$ Step (10-90%), $f = 1\text{ MHz}$ |                     | 7                  |                     | ns                           |
| $t_f$                                   | Fall Time  |  |                     | 6                  |                     | ns                           |
| $t_s$                                   | Settling Time to 0.1%  | 1 $V_{PP}$ Step, $f = 1\text{ MHz}$            |                     | 80                 |                     | ns                           |
| OS                                      | Overshoot  | 0.1 $V_{PP}$ Step, $f = 1\text{ MHz}$          |                     | 20                 |                     | %                            |
| SR                                      | Slew Rate <sup>(4)</sup>                                     | $V_{IN} = 1.6 V_{PP}$ , $f = 26\text{ MHz}$    |                     | 120                |                     | $\text{V}/\mu\text{s}$       |
| <b>Static DC Performance</b>            |  |  |                     |                    |                     |                              |
| $I_S$                                   | Supply Current   | $\text{Enable}_{1,2} = V_{DD}$ ; No Load       |                     | 2.5                | 3.5<br><b>3.8</b>   | mA                           |
|   |  | $\text{Enable}_{1,2} = V_{SS}$ ; No Load       |                     | 62                 | 80<br><b>89</b>     |                              |
| PSRR                                    | Power Supply Rejection Ratio                                 | DC (3.0V to 5.0V)                              | 58<br><b>57</b>     | 68                 |                     | dB                           |
| $A_{CL}$                                | Small Signal Voltage Gain                                    | $V_{OUT} = 0.1 V_{PP}$                         | 0.99<br><b>0.97</b> | 1.00               | 1.01<br><b>1.03</b> | V/V                          |
| $V_{OS}$                                | Output Offset Voltage  |  |                     | 1.3                | 16<br><b>17</b>     | mV                           |
| TC $V_{OS}$                             | Temperature Coefficient Output Offset Voltage <sup>(5)</sup> |  |                     | 3                  |                     | $\mu\text{V}/^\circ\text{C}$ |
| $R_{OUT}$                               | Output Resistance  | $f = 100\text{ kHz}$                           |                     | 0.5                |                     | $\Omega$                     |
|   |  | $f = 26\text{ MHz}$                            |                     | 118                |                     |                              |

- (1) Electrical Table values apply only for factory testing conditions at the temperature indicated. Factory testing conditions result in very limited self-heating of the device such that  $T_J = T_A$ .
- (2) All limits are specified by testing or statistical analysis.
- (3) Typical Values represent the most likely parametric norm.
- (4) Slew rate is the average of the positive and negative slew rate.
- (5) Average Temperature Coefficient is determined by dividing the changing in a parameter at temperature extremes by the total temperature change.

**5V ELECTRICAL CHARACTERISTICS (continued)**

Unless otherwise specified, all limits are specified for  $T_J = 25^\circ\text{C}$ ,  $V_{DD} = 5\text{V}$ ,  $V_{SS} = 0\text{V}$ ,  $V_{CM} = 1\text{V}$ ,  $\text{Enable}_{1,2} = V_{DD}$ ,  $C_L = 20\text{pF}$ ,  $R_L = 30\text{k}\Omega$ ,  $C_{COUPLING} = 1\text{nF}$ . **Boldface** limits apply at temperature range extremes of operating condition. See <sup>(1)</sup>.

| Symbol                           | Parameter                                   | Conditions                           | Min <sup>(2)</sup>  | Typ <sup>(3)</sup> | Max <sup>(2)</sup> | Units |
|----------------------------------|---|--------------------------------------|---------------------|--------------------|--------------------|-------|
| <b>Miscellaneous Performance</b> |   |                                      |                     |                    |                    |       |
| R <sub>IN</sub>                  | Input Resistance per Buffer                 | Enable = V <sub>DD</sub>             |                     | 134                |                    | kΩ    |
|                                  |   | Enable = V <sub>SS</sub>             |                     | 134                |                    |       |
| C <sub>IN</sub>                  | Input Capacitance per Buffer                | Enable = V <sub>DD</sub>             |                     | 2.0                |                    | pF    |
|                                  |   | Enable = V <sub>SS</sub>             |                     | 2.0                |                    |       |
| Z <sub>IN</sub>                  | Input Impedance                             | f = 26 MHz, Enable = V <sub>DD</sub> |                     | 7.2                |                    | kΩ    |
|                                  |   | f = 26 MHz, Enable = V <sub>SS</sub> |                     | 8.0                |                    |       |
| V <sub>O</sub>                   | Output Swing Positive                       | V <sub>IN</sub> = V <sub>DD</sub>    | 4.96<br><b>4.94</b> | 4.99               |                    | V     |
|                                  | Output Swing Negative                       | V <sub>IN</sub> = V <sub>SS</sub>    |                     | 10                 | 40<br><b>55</b>    | mV    |
| I <sub>SC</sub>                  | Output Short-Circuit Current <sup>(6)</sup> | Sourcing                             | -40<br><b>-28</b>   | -68                |                    | mA    |
|                                  |   | Sinking                              | 70<br><b>50</b>     | 98                 |                    |       |
| V <sub>en_hmin</sub>             | Enable High Active Minimum Voltage          |                                      |                     | 1.2                |                    | V     |
| V <sub>en_lmax</sub>             | Enable Low Inactive Maximum Voltage         |                                      |                     | 0.6                |                    |       |

(6) Short-Circuit test is a momentary test. Continuous short circuit operation at elevated ambient temperature can result in exceeding the maximum allowed junction temperature of 150°C.

**BLOCK DIAGRAM**

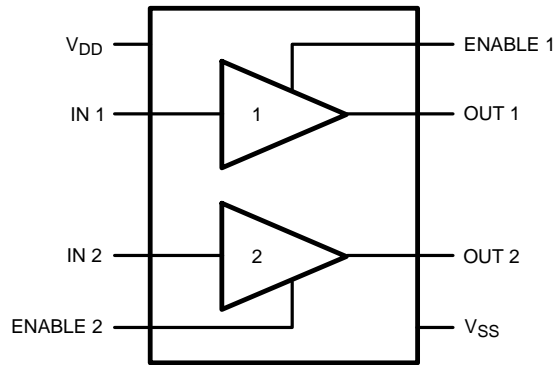

Figure 2.

**PIN DESCRIPTIONS**

| Pin No. | Pin Name        | Description               |
|---------|-----------------|---------------------------|
| 1       | V <sub>DD</sub> | Voltage supply connection |
| 2       | IN 1            | Input 1                   |
| 3       | IN 2            | Input 2                   |
| 4       | ENABLE 2        | Enable buffer 2           |
| 5       | V <sub>SS</sub> | Ground connection         |
| 6       | OUT 2           | Output 2                  |
| 7       | OUT 1           | Output 1                  |
| 8       | ENABLE 1        | Enable buffer 1           |

**CONNECTION DIAGRAM**

**Top View**

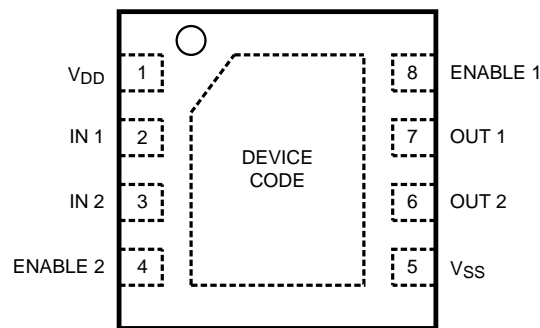

Figure 3. 8-Pin WSON (NGQ Package)

**TYPICAL PERFORMANCE CHARACTERISTICS**

$T_J = 25^\circ\text{C}$ ,  $V_{DD} = 2.7\text{V}$ ,  $V_{SS} = 0\text{V}$ ,  $\text{Enable}_{1,2} = V_{DD}$ ,  $C_L = 20\text{ pF}$ ,  $R_L = 30\text{ k}\Omega$  and  $C_{\text{COUPLING}} = 1\text{ nF}$ , unless otherwise specified.

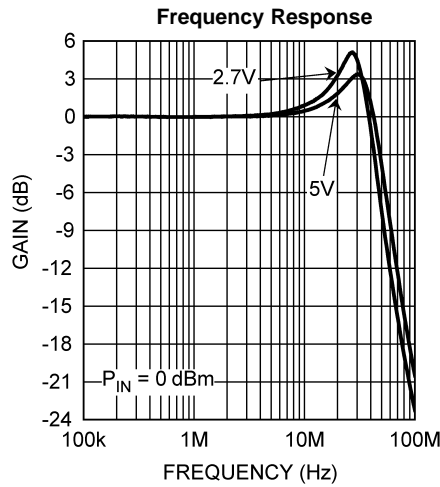

Figure 4.

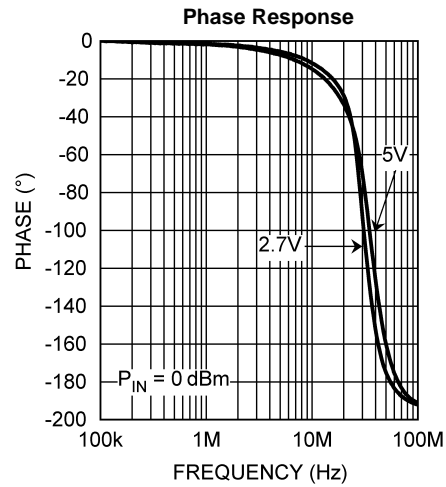

Figure 5.

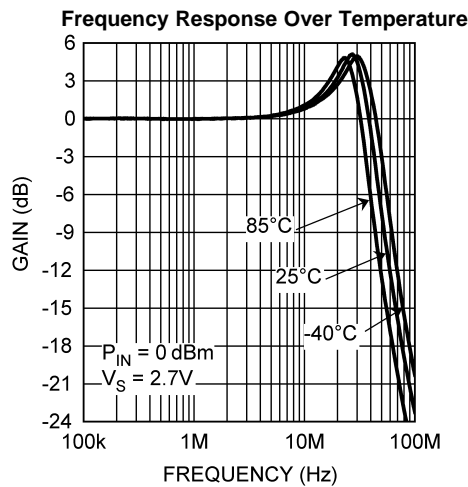

Figure 6.

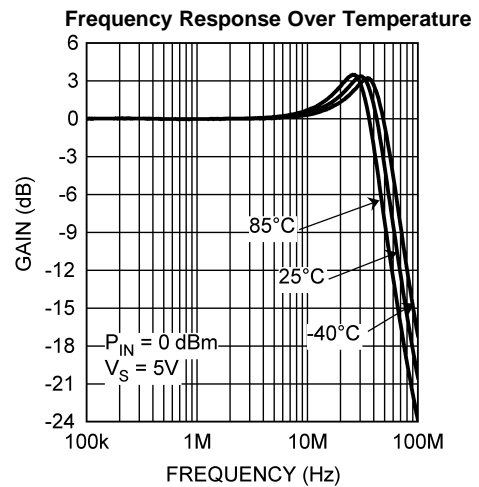

Figure 7.

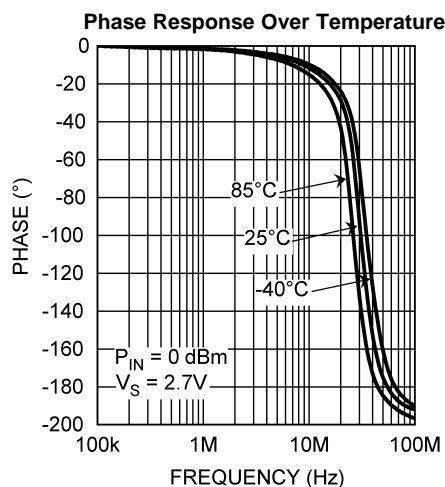

Figure 8.

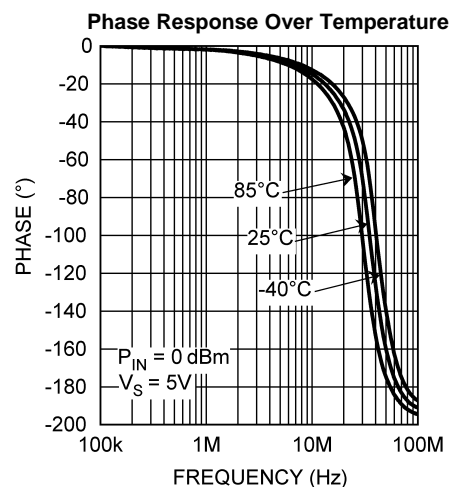

Figure 9.

**TYPICAL PERFORMANCE CHARACTERISTICS (continued)**

$T_J = 25^\circ\text{C}$ ,  $V_{DD} = 2.7\text{V}$ ,  $V_{SS} = 0\text{V}$ ,  $\text{Enable}_{1,2} = V_{DD}$ ,  $C_L = 20\text{ pF}$ ,  $R_L = 30\text{ k}\Omega$  and  $C_{\text{COUPLING}} = 1\text{ nF}$ , unless otherwise specified.

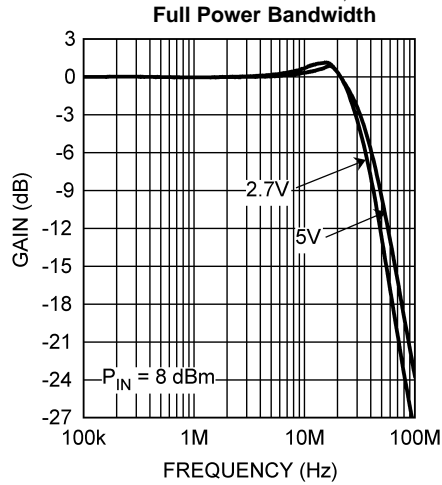

Figure 10.

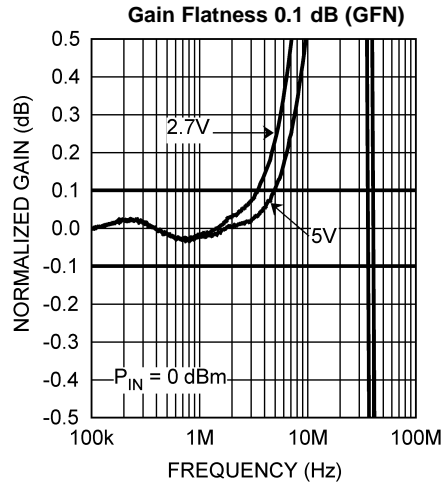

Figure 11.

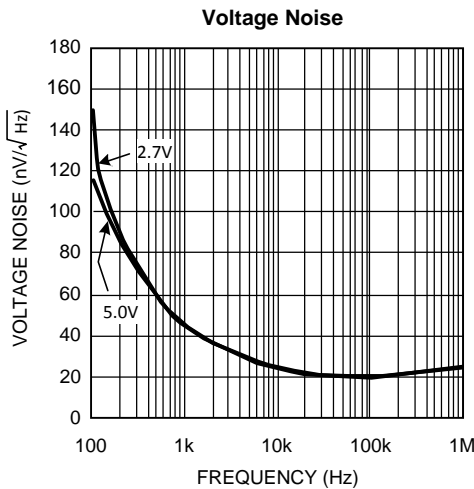

Figure 12.

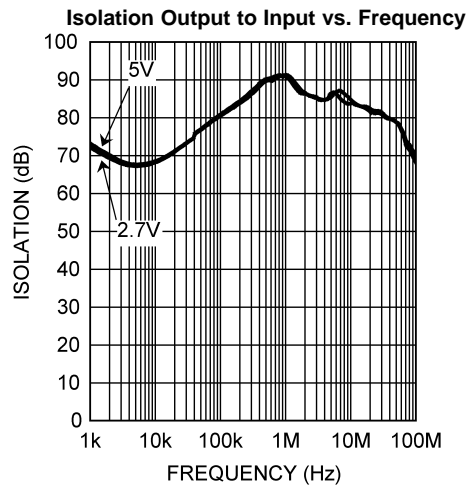

Figure 13.

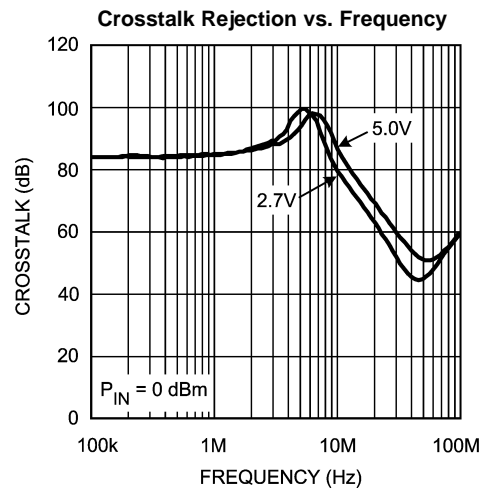

Figure 14.

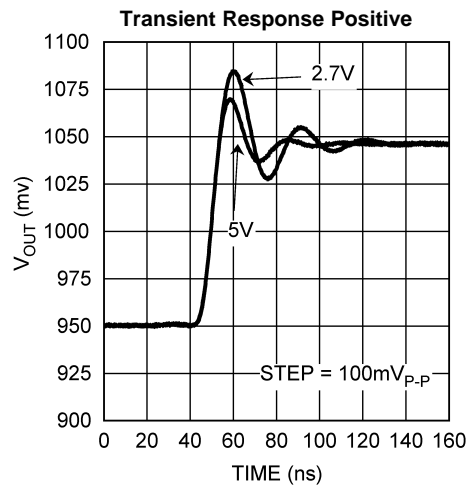

Figure 15.



**TYPICAL PERFORMANCE CHARACTERISTICS (continued)**

$T_J = 25^\circ\text{C}$ ,  $V_{DD} = 2.7\text{V}$ ,  $V_{SS} = 0\text{V}$ ,  $\text{Enable}_{1,2} = V_{DD}$ ,  $C_L = 20\text{ pF}$ ,  $R_L = 30\text{ k}\Omega$  and  $C_{\text{COUPLING}} = 1\text{ nF}$ , unless otherwise specified.

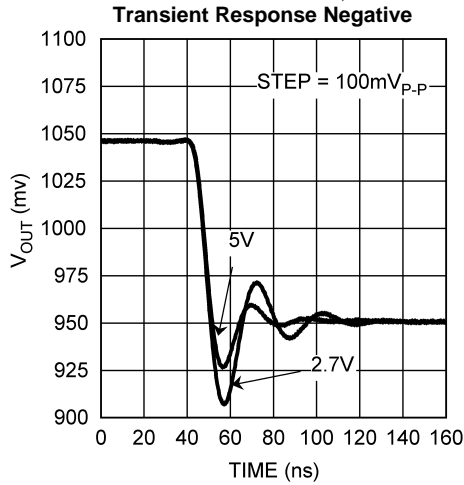

Figure 16.

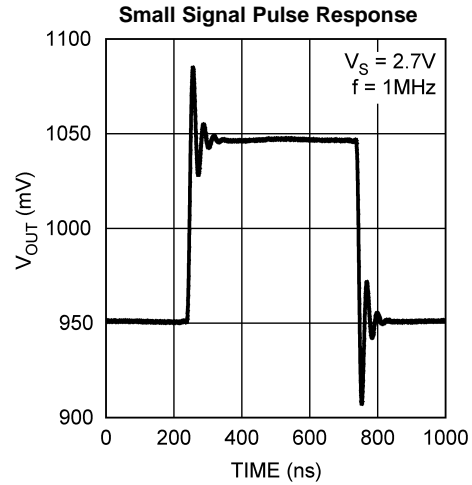

Figure 17.

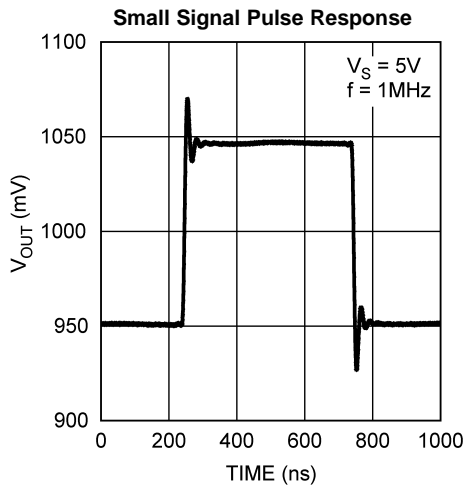

Figure 18.

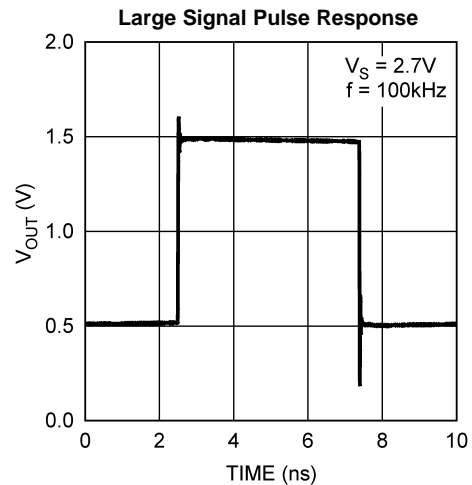

Figure 19.

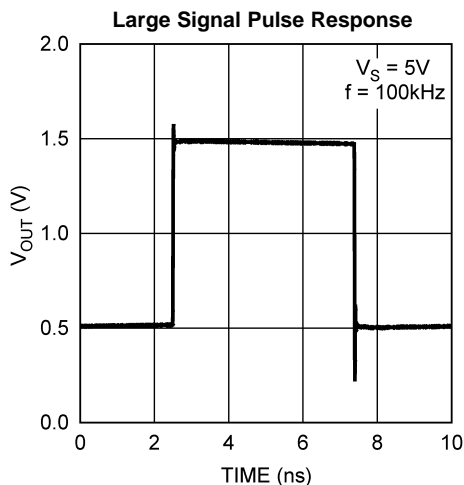

Figure 20.

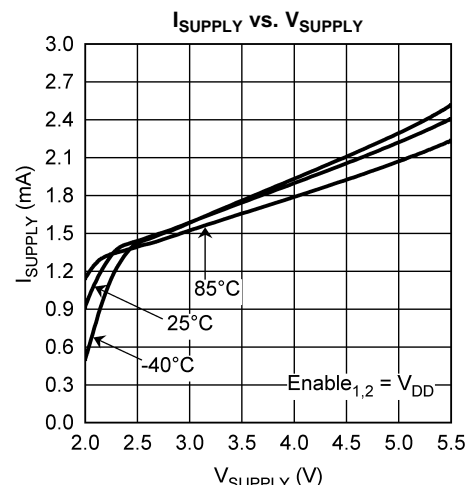
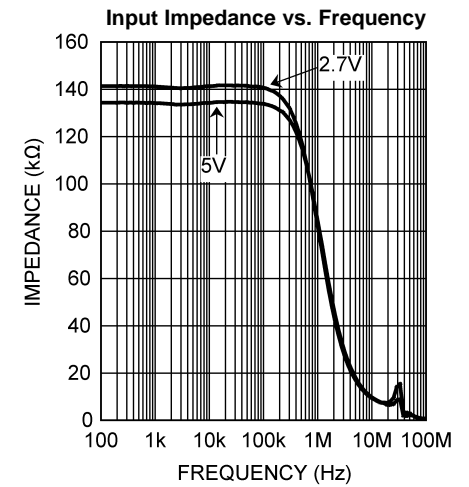
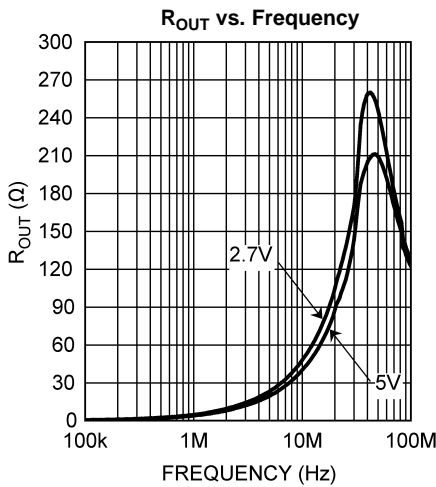
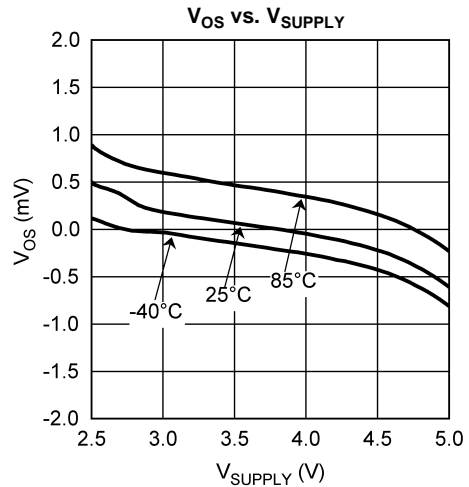
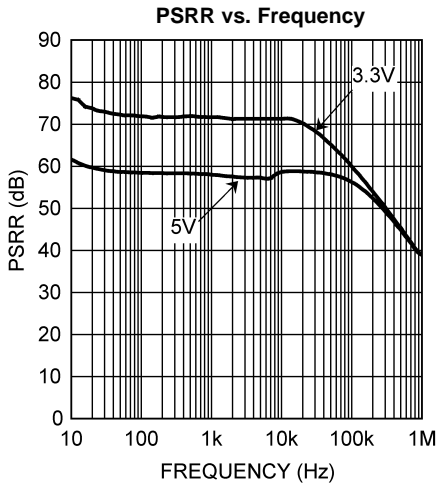
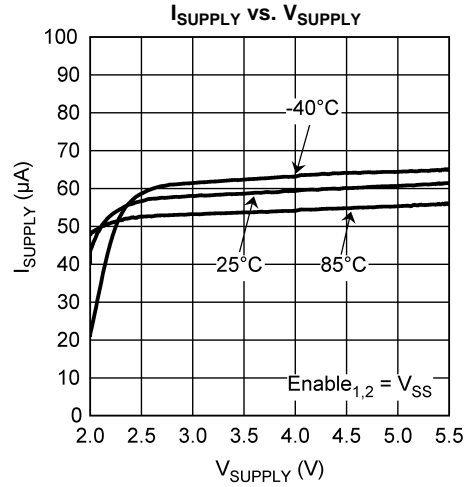
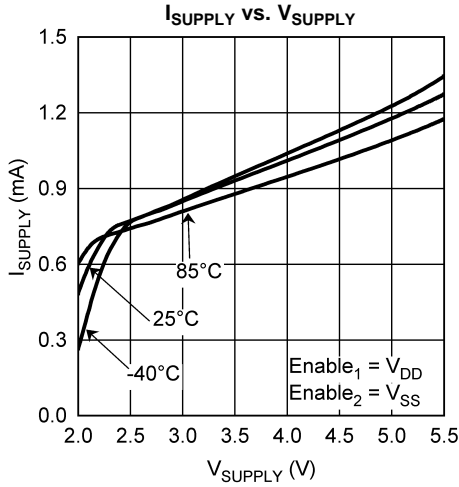

Figure 21.

**TYPICAL PERFORMANCE CHARACTERISTICS (continued)**

$T_J = 25^\circ\text{C}$ ,  $V_{DD} = 2.7\text{V}$ ,  $V_{SS} = 0\text{V}$ ,  $\text{Enable}_{1,2} = V_{DD}$ ,  $C_L = 20\text{ pF}$ ,  $R_L = 30\text{ k}\Omega$  and  $C_{\text{COUPLING}} = 1\text{ nF}$ , unless otherwise specified.



**TYPICAL PERFORMANCE CHARACTERISTICS (continued)**

$T_J = 25^\circ\text{C}$ ,  $V_{DD} = 2.7\text{V}$ ,  $V_{SS} = 0\text{V}$ ,  $\text{Enable}_{1,2} = V_{DD}$ ,  $C_L = 20\text{ pF}$ ,  $R_L = 30\text{ k}\Omega$  and  $C_{\text{COUPLING}} = 1\text{ nF}$ , unless otherwise specified.

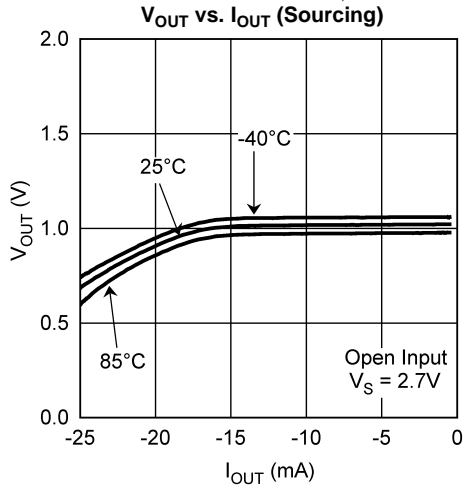

Figure 28.

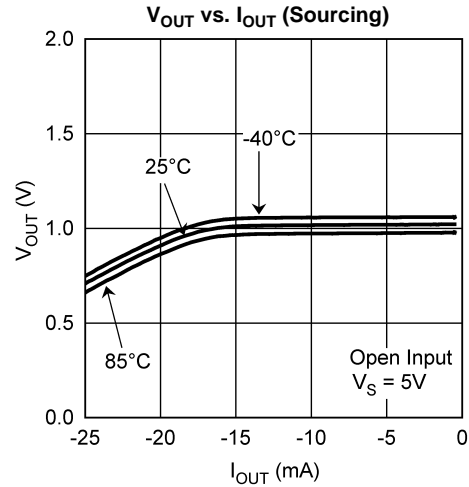

Figure 29.

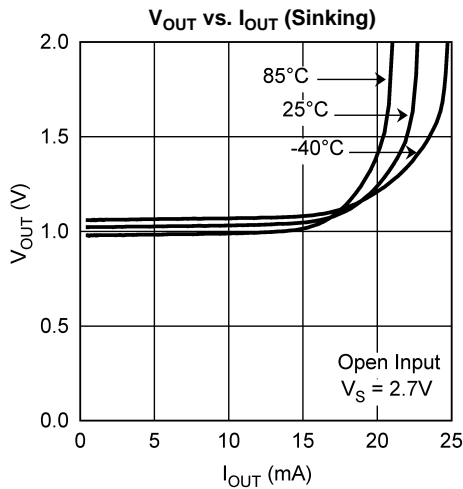

Figure 30.

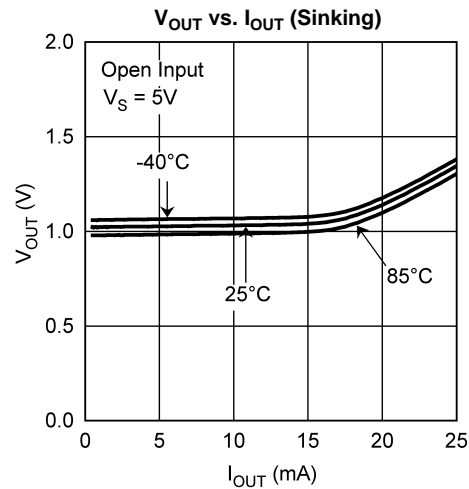

Figure 31.

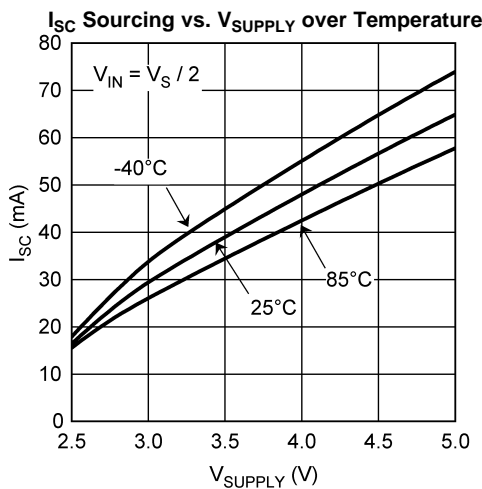

Figure 32.

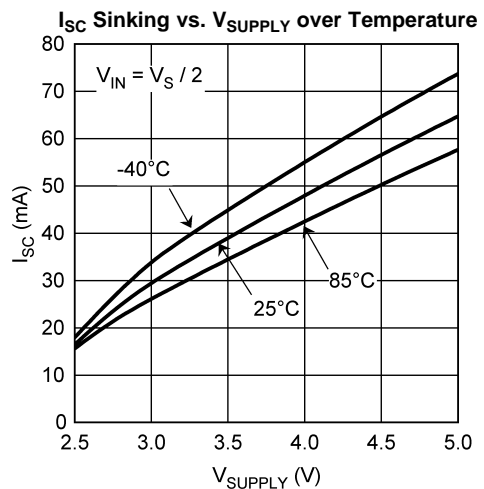
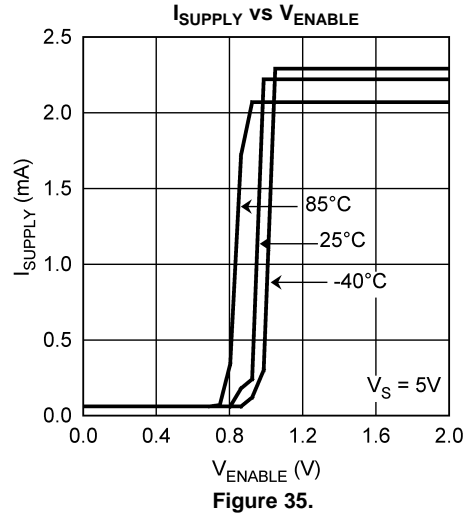
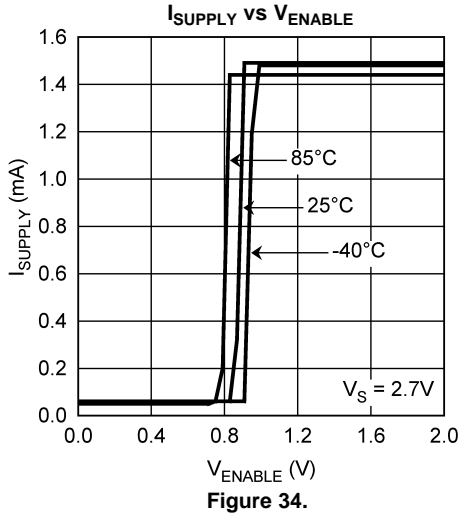

Figure 33.

### TYPICAL PERFORMANCE CHARACTERISTICS (continued)

$T_J = 25^\circ\text{C}$ ,  $V_{DD} = 2.7\text{V}$ ,  $V_{SS} = 0\text{V}$ ,  $\text{Enable}_{1,2} = V_{DD}$ ,  $C_L = 20\text{ pF}$ ,  $R_L = 30\text{ k}\Omega$  and  $C_{\text{COUPLING}} = 1\text{ nF}$ , unless otherwise specified.



## APPLICATION INFORMATION

### GENERAL

The LMV112 is designed to minimize the effects of spurious signals from the base band chip to the oscillator. Also the influence of varying load resistance and capacitance to the oscillator is minimized, while the drive capability is increased.

The inputs of the LMV112 are internally biased at 1V, making AC coupling possible without external bias resistors.

To optimize current consumption, the buffer not in use can be disabled by connecting the enable pin to  $V_{SS}$ .

The LMV112 has no internal ground reference; therefore, either single or split supply configurations can be used.

The LMV112 is an easy replacement for discrete circuitry. It simplifies board layout and minimizes the effect of layout related parasitic components.

### INPUT CONFIGURATION

AC coupling is made possible by biasing the input. A large DC load at the oscillator input could change the load impedance and therefore it's oscillating frequency. To avoid external resistors the inputs are internally biased. This biasing is set at 1V as depicted in [Figure 36](#). Because this biasing is set at 1V, the maximum amplitude of the AC signal is  $2 V_{PP}$ .

The coupling capacitance should be large enough to let the AC signal pass. This is a unity gain buffer with rail-to-rail inputs and outputs.

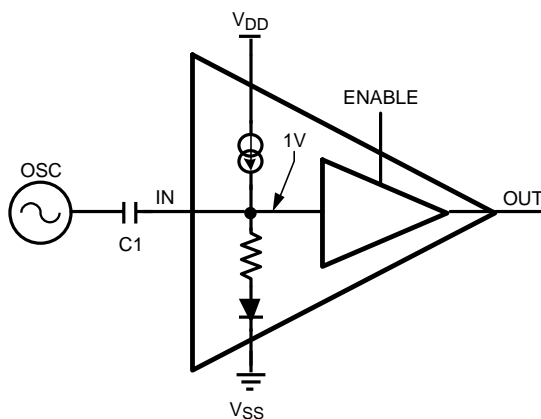

Figure 36. Input Configuration

### FREQUENCY PULLING

Frequency pulling is the frequency variation of an oscillator caused by a varying load. In the typical application, the load of the oscillator is a fixed capacitor ( $C1$ ) and the input impedance of the buffer.

To keep the input impedance as constant as possible, the input is biased at 1V, even when the part is disabled. A simplified schematic of the input configuration is shown in [Figure 36](#).

## ISOLATION AND CROSSTALK

Output to input isolation prevents the clock from being affected by spurious signals generated by the digital blocks at the output buffer. See the characteristic graphic entitled “Isolation Output to Input vs. Frequency” in the [TYPICAL PERFORMANCE CHARACTERISTICS](#) section.

A block diagram of the isolation is shown in [Figure 37](#). Crosstalk rejection between buffers prevents signals from affecting each other. [Figure 37](#) shows a Base band IC and a Bluetooth module as examples of this. For more information, see the characteristic graphic labeled “Crosstalk Rejection vs. Frequency” in the [TYPICAL PERFORMANCE CHARACTERISTICS](#) section.

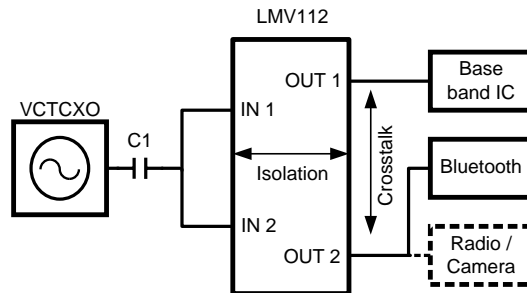
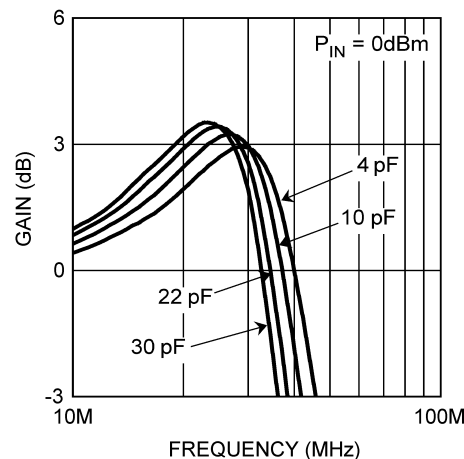

**Figure 37. Isolation Block Diagram**

## DRIVING CAPACITIVE LOADS

Each buffer can drive a capacitive load. Be aware that every capacitor directly connected to the output becomes part of the loop of the buffer. In most applications the load consists of the capacitance of copper tracks and the input capacitance of the application blocks. Capacitance reduces the gain/phase margin and increases the instability. It leads to peaking in the frequency response and in extreme situations oscillations can occur. To drive a large capacitive load it is recommended that a series resistor is included between the buffer and the load capacitor. The best value for this isolation resistance is often found by experimentation.

The LMV112 datasheet reflects measurements with capacitance loads of 20 pF at the output of the buffers. Most common applications will probably use a lower capacitance load, which will result in lower peaking and significantly greater bandwidth, see [Figure 38](#).



**Figure 38. Bandwidth and Peaking**

## LAYOUT DESIGN RECOMMENDATION

Careful consideration for circuitry design and PCB layout will eliminate problems and will optimize the performance of the LMV112. It is best to have the same ground plane on the PCB for all power supply lines. This gives a low impedance return path for all decoupling and other ground connections.

To ensure a clean supply voltage it is best to place decoupling capacitors close to the LMV112, between  $V_{CC}$  and ground. The output of the VCO must be correctly terminated with proper load impedance.

Another important issue is the value of the components, which also determines the sensitivity to disturbances. Resistor values should be but avoid using values that cause a significant increase in power consumption while loading inputs or outputs to heavily.

---

## REVISION HISTORY

| Changes from Revision A (May 2013) to Revision B           | Page               |
|--|--------------------|
| • Changed layout of National Data Sheet to TI format ..... | <a href="#">15</a> |

---



**PACKAGING INFORMATION**

| Orderable part number          | Status<br>(1) | Material type<br>(2) | Package   Pins | Package qty   Carrier | RoHS<br>(3) | Lead finish/<br>Ball material<br>(4) | MSL rating/<br>Peak reflow<br>(5) | Op temp (°C) | Part marking<br>(6) |
|--------------------------------|---------------|----------------------|----------------|-----------------------|-------------|--------------------------------------|-----------------------------------|--------------|---------------------|
| <a href="#">LMV112SD/NOPB</a>  | Active        | Production           | WSON (NGQ)   8 | 1000   SMALL T&R      | Yes         | SN                                   | Level-1-260C-UNLIM                | -40 to 85    | 112SD               |
| LMV112SD/NOPB.A                | Active        | Production           | WSON (NGQ)   8 | 1000   SMALL T&R      | Yes         | SN                                   | Level-1-260C-UNLIM                | -40 to 85    | 112SD               |
| <a href="#">LMV112SDX/NOPB</a> | Active        | Production           | WSON (NGQ)   8 | 4500   LARGE T&R      | Yes         | SN                                   | Level-1-260C-UNLIM                | -40 to 85    | 112SD               |
| LMV112SDX/NOPB.A               | Active        | Production           | WSON (NGQ)   8 | 4500   LARGE T&R      | Yes         | SN                                   | Level-1-260C-UNLIM                | -40 to 85    | 112SD               |

(1) **Status:** For more details on status, see our [product life cycle](#).

(2) **Material type:** When designated, preproduction parts are prototypes/experimental devices, and are not yet approved or released for full production. Testing and final process, including without limitation quality assurance, reliability performance testing, and/or process qualification, may not yet be complete, and this item is subject to further changes or possible discontinuation. If available for ordering, purchases will be subject to an additional waiver at checkout, and are intended for early internal evaluation purposes only. These items are sold without warranties of any kind.

(3) **RoHS values:** Yes, No, RoHS Exempt. See the [TI RoHS Statement](#) for additional information and value definition.

(4) **Lead finish/Ball material:** Parts may have multiple material finish options. Finish options are separated by a vertical ruled line. Lead finish/Ball material values may wrap to two lines if the finish value exceeds the maximum column width.

(5) **MSL rating/Peak reflow:** The moisture sensitivity level ratings and peak solder (reflow) temperatures. In the event that a part has multiple moisture sensitivity ratings, only the lowest level per JEDEC standards is shown. Refer to the shipping label for the actual reflow temperature that will be used to mount the part to the printed circuit board.

(6) **Part marking:** There may be an additional marking, which relates to the logo, the lot trace code information, or the environmental category of the part.

Multiple part markings will be inside parentheses. Only one part marking contained in parentheses and separated by a "~" will appear on a part. If a line is indented then it is a continuation of the previous line and the two combined represent the entire part marking for that device.

**Important Information and Disclaimer:** The information provided on this page represents TI's knowledge and belief as of the date that it is provided. TI bases its knowledge and belief on information provided by third parties, and makes no representation or warranty as to the accuracy of such information. Efforts are underway to better integrate information from third parties. TI has taken and continues to take reasonable steps to provide representative and accurate information but may not have conducted destructive testing or chemical analysis on incoming materials and chemicals. TI and TI suppliers consider certain information to be proprietary, and thus CAS numbers and other limited information may not be available for release.

In no event shall TI's liability arising out of such information exceed the total purchase price of the TI part(s) at issue in this document sold by TI to Customer on an annual basis.

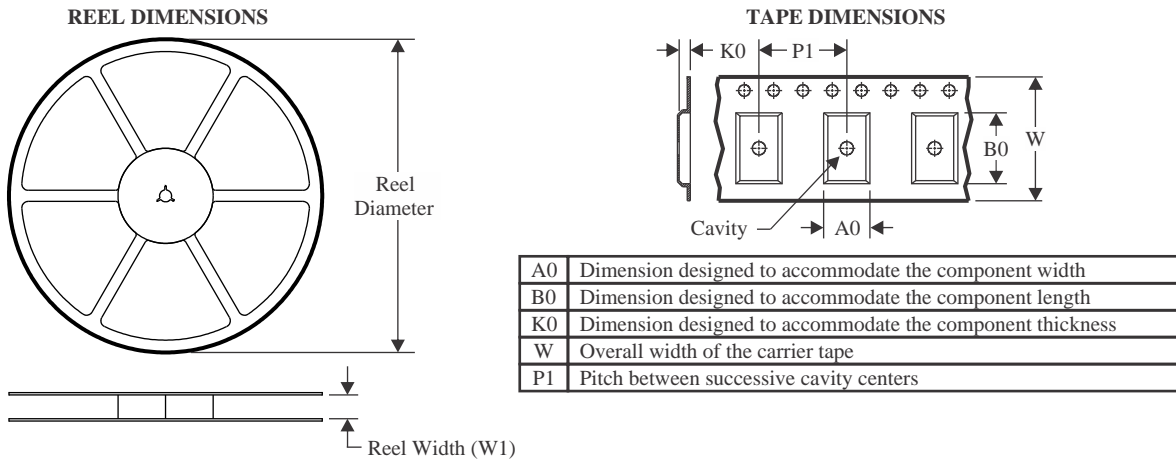
**TAPE AND REEL INFORMATION**

**QUADRANT ASSIGNMENTS FOR PIN 1 ORIENTATION IN TAPE**

\*All dimensions are nominal

| Device         | Package Type | Package Drawing | Pins | SPQ  | Reel Diameter (mm) | Reel Width W1 (mm) | A0 (mm) | B0 (mm) | K0 (mm) | P1 (mm) | W (mm) | Pin1 Quadrant |
|----------------|--------------|-----------------|------|------|--------------------|--------------------|---------|---------|---------|---------|--------|---------------|
| LMV112SD/NOPB  | WSO          | NGQ             | 8    | 1000 | 177.8              | 12.4               | 3.3     | 3.3     | 1.0     | 8.0     | 12.0   | Q1            |
| LMV112SDX/NOPB | WSO          | NGQ             | 8    | 4500 | 330.0              | 12.4               | 3.3     | 3.3     | 1.0     | 8.0     | 12.0   | Q1            |

**TAPE AND REEL BOX DIMENSIONS**

\*All dimensions are nominal

| Device         | Package Type | Package Drawing | Pins | SPQ  | Length (mm) | Width (mm) | Height (mm) |
|----------------|--------------|-----------------|------|------|-------------|------------|-------------|
| LMV112SD/NOPB  | WSON         | NGQ             | 8    | 1000 | 208.0       | 191.0      | 35.0        |
| LMV112SDX/NOPB | WSON         | NGQ             | 8    | 4500 | 367.0       | 367.0      | 35.0        |

# NGQ0008A

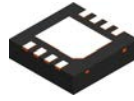

# PACKAGE OUTLINE

## WSO - 0.8 mm max height

PLASTIC SMALL OUTLINE - NO LEAD

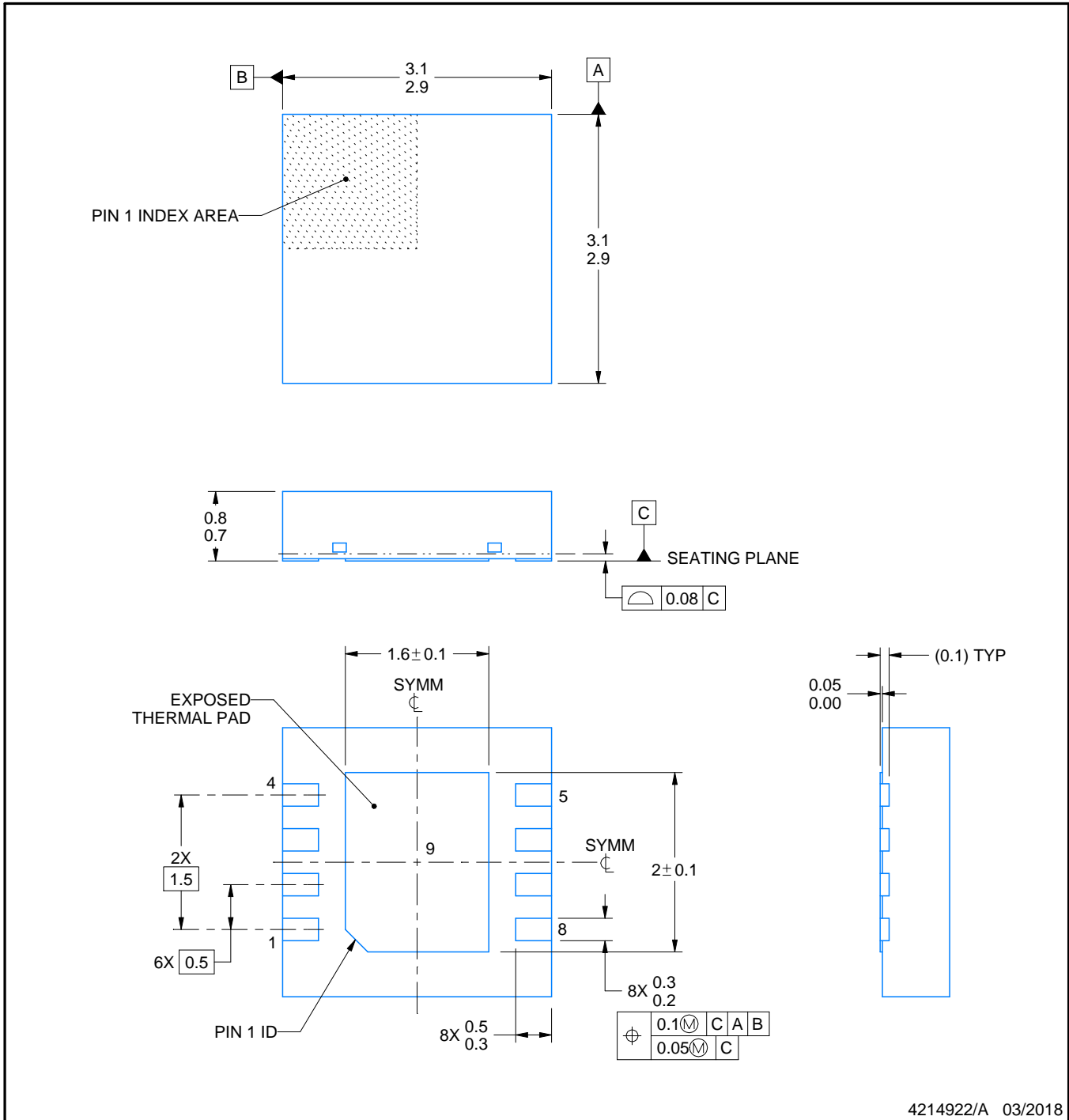

4214922/A 03/2018

**NOTES:**

1. All linear dimensions are in millimeters. Any dimensions in parenthesis are for reference only. Dimensioning and tolerancing per ASME Y14.5M.
2. This drawing is subject to change without notice.
3. The package thermal pad must be soldered to the printed circuit board for thermal and mechanical performance.

# EXAMPLE BOARD LAYOUT

NGQ0008A

WSON - 0.8 mm max height

PLASTIC SMALL OUTLINE - NO LEAD

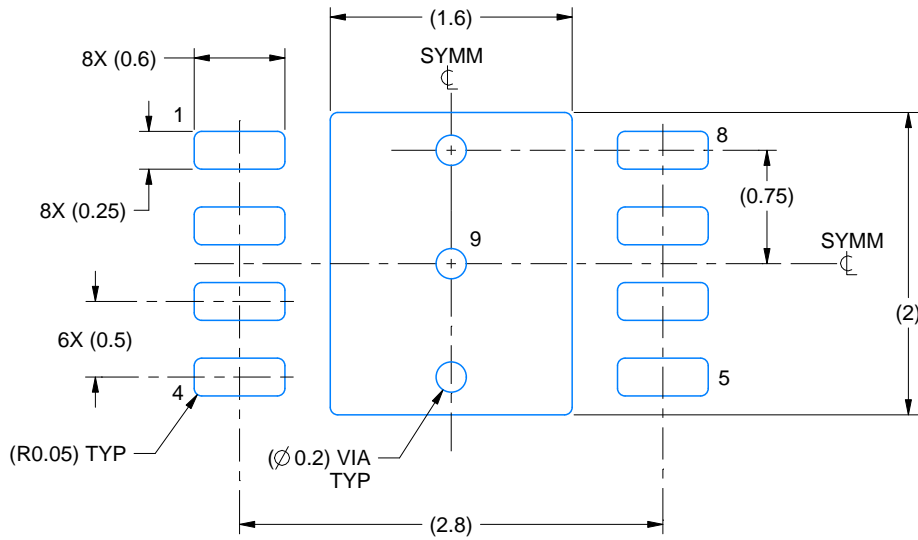

**LAND PATTERN EXAMPLE**  
EXPOSED METAL SHOWN  
SCALE:20X

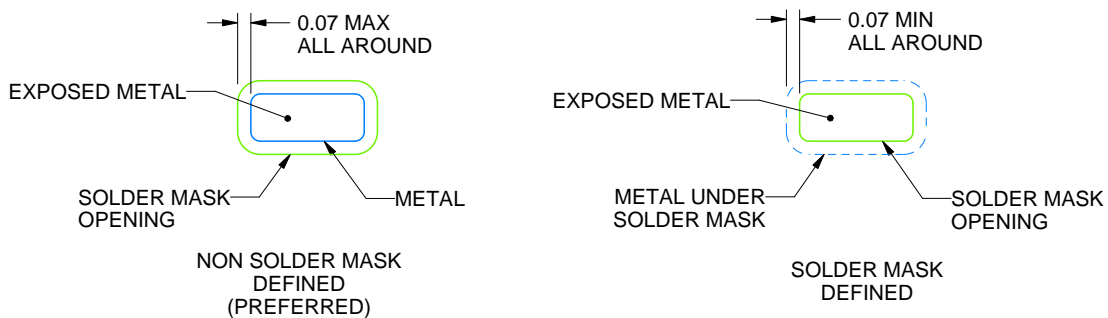

**SOLDER MASK DETAILS**

4214922/A 03/2018

NOTES: (continued)

4. This package is designed to be soldered to a thermal pad on the board. For more information, see Texas Instruments literature number SLUA271 ([www.ti.com/lit/sluea271](http://www.ti.com/lit/sluea271)).
5. Vias are optional depending on application, refer to device data sheet. If any vias are implemented, refer to their locations shown on this view. It is recommended that vias under paste be filled, plugged or tented.

# EXAMPLE STENCIL DESIGN

NGQ0008A

WSON - 0.8 mm max height

PLASTIC SMALL OUTLINE - NO LEAD

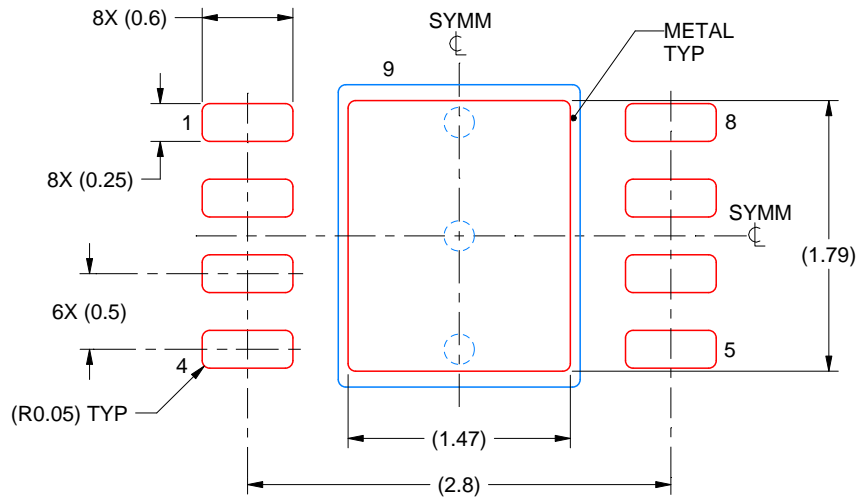

SOLDER PASTE EXAMPLE  
BASED ON 0.1 mm THICK STENCIL

EXPOSED PAD 9:  
82% PRINTED SOLDER COVERAGE BY AREA UNDER PACKAGE  
SCALE:20X

4214922/A 03/2018

NOTES: (continued)

6. Laser cutting apertures with trapezoidal walls and rounded corners may offer better paste release. IPC-7525 may have alternate design recommendations.

## IMPORTANT NOTICE AND DISCLAIMER

TI PROVIDES TECHNICAL AND RELIABILITY DATA (INCLUDING DATASHEETS), DESIGN RESOURCES (INCLUDING REFERENCE DESIGNS), APPLICATION OR OTHER DESIGN ADVICE, WEB TOOLS, SAFETY INFORMATION, AND OTHER RESOURCES "AS IS" AND WITH ALL FAULTS, AND DISCLAIMS ALL WARRANTIES, EXPRESS AND IMPLIED, INCLUDING WITHOUT LIMITATION ANY IMPLIED WARRANTIES OF MERCHANTABILITY, FITNESS FOR A PARTICULAR PURPOSE OR NON-INFRINGEMENT OF THIRD PARTY INTELLECTUAL PROPERTY RIGHTS.

These resources are intended for skilled developers designing with TI products. You are solely responsible for (1) selecting the appropriate TI products for your application, (2) designing, validating and testing your application, and (3) ensuring your application meets applicable standards, and any other safety, security, regulatory or other requirements.

These resources are subject to change without notice. TI grants you permission to use these resources only for development of an application that uses the TI products described in the resource. Other reproduction and display of these resources is prohibited. No license is granted to any other TI intellectual property right or to any third party intellectual property right. TI disclaims responsibility for, and you fully indemnify TI and its representatives against any claims, damages, costs, losses, and liabilities arising out of your use of these resources.

TI's products are provided subject to [TI's Terms of Sale](#), [TI's General Quality Guidelines](#), or other applicable terms available either on [ti.com](http://ti.com) or provided in conjunction with such TI products. TI's provision of these resources does not expand or otherwise alter TI's applicable warranties or warranty disclaimers for TI products. Unless TI explicitly designates a product as custom or customer-specified, TI products are standard, catalog, general purpose devices.

TI objects to and rejects any additional or different terms you may propose.

Copyright © 2025, Texas Instruments Incorporated

Last updated 10/2025