

SINGLE 10-A OUTPUT, 4.75-V to 14-V INPUT, NON-ISOLATED, DIGITAL POWERTRAIN™ MODULE

Check for Samples: [PTD08A210W](#)

FEATURES

- **Single 10-A Output**
- **4.75-V to 14-V Input Voltage**
- **Programmable Wide-Output Voltage (0.7 V to 3.6 V)**
- **Efficiencies up to 96%**
- **Digital I/O**
 - PWM signal
 - Fault Flag (FF)
 - Synchronous Rectifier Enable (SRE)
- **Analog I/O**
 - Temperature
 - Output current
- **Safety Agency Approvals:**
 - UL/IEC/CSA-C22.2 60950-1
- **Operating Temperature: –40°C to 85°C**

APPLICATIONS

- **Digital Power Systems using UCD9XXX Digital Controllers**

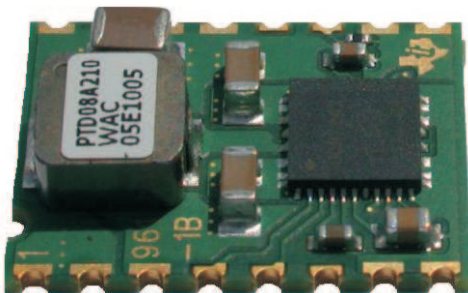

DESCRIPTION

The PTD08A210W is a high-performance single 10-A output, non-isolated digital PowerTrain module. This module is the power conversion section of a digital power system which incorporates TI's UCD7242 MOSFET/driver IC. The PTD08A210W must be used in conjunction with a digital power controller such as the UCD9240, UCD9220 or UCD9110 family. The PTD08A210W receives control signals from the digital controller and provides parametric and status information back to the digital controller. Together, PowerTrain modules and a digital power controller form a sophisticated, robust, and easily configured power management solution.

Operating from an input voltage range of 4.75 V to 14 V, the PTD08A210W provides step-down power conversion to a wide range of output voltages from, 0.7 V to 3.6 V. The wide input voltage range makes the PTD08A210W particularly suitable for advanced computing and server applications that utilize a loosely regulated 8-V, 9.6-V or 12-V intermediate distribution bus. Additionally, the wide input voltage range increases design flexibility by supporting operation with tightly regulated 5-V or 12-V intermediate bus architectures.

The module incorporates output over-current and temperature monitoring which protects against most load faults. Output current and module temperature signals are provided for the digital controller to permit user defined over-current and over-temperature warning and fault scenarios.

The module uses single-sided, pin-less surface mount construction to provide a low profile and compact footprint. The package is lead (Pb) - free and RoHS compatible.



Please be aware that an important notice concerning availability, standard warranty, and use in critical applications of Texas Instruments semiconductor products and disclaimers thereto appears at the end of this data sheet.

POWERTRAIN is a trademark of Texas Instruments.

PRODUCTION DATA information is current as of publication date. Products conform to specifications per the terms of the Texas Instruments standard warranty. Production processing does not necessarily include testing of all parameters.

Copyright © 2010, Texas Instruments Incorporated



This integrated circuit can be damaged by ESD. Texas Instruments recommends that all integrated circuits be handled with appropriate precautions. Failure to observe proper handling and installation procedures can cause damage.

ESD damage can range from subtle performance degradation to complete device failure. Precision integrated circuits may be more susceptible to damage because very small parametric changes could cause the device not to meet its published specifications.

Standard PTD08A210W Application

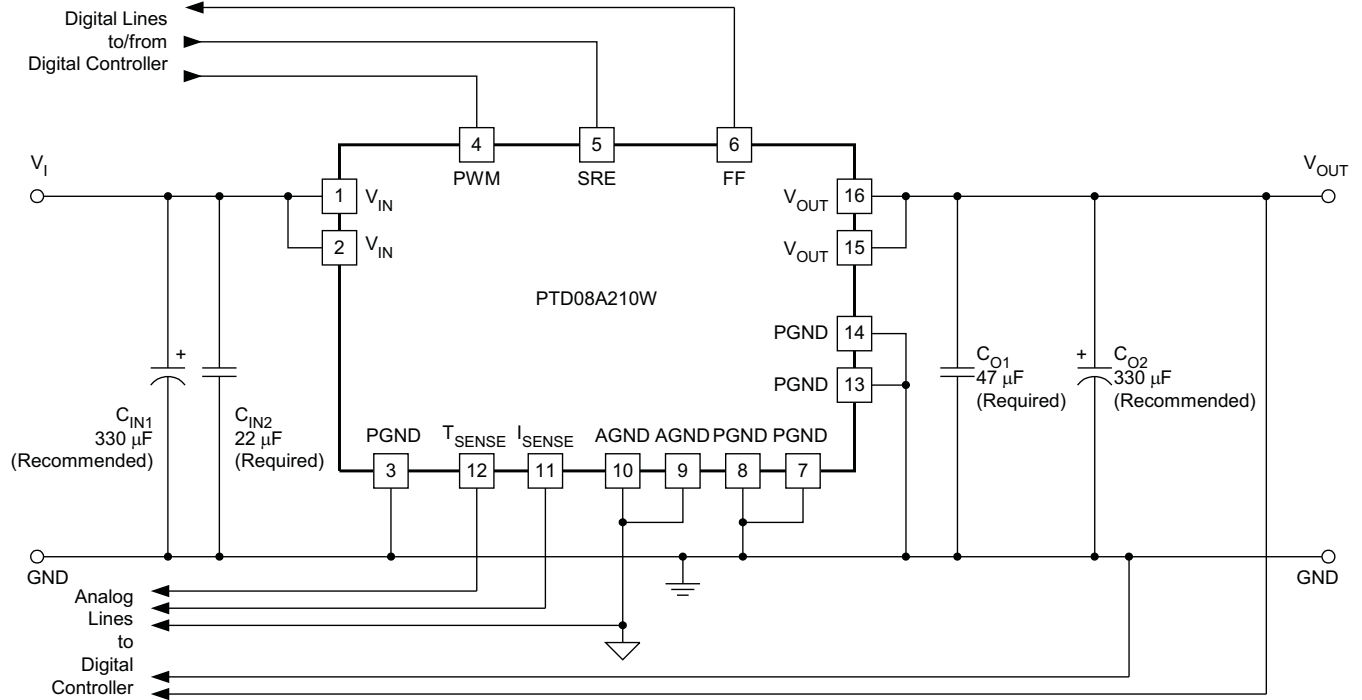

UDG-10063

ORDERING INFORMATION

For the most current package and ordering information, see the Package Option Addendum at the end of this datasheet, or see the TI website at www.ti.com.

DATASHEET TABLE OF CONTENTS

DATASHEET SECTION	PAGE NUMBER
ENVIRONMENTAL AND ABSOLUTE MAXIMUM RATINGS	3
ELECTRICAL CHARACTERISTICS TABLE	4
TERMINAL FUNCTIONS	5
TYPICAL CHARACTERISTICS ($V_I = 12V$)	6
TYPICAL CHARACTERISTICS ($V_I = 5V$)	7
TYPICAL APPLICATION SCHEMATIC	9
GRAPHICAL USER INTERFACE VALUES	10
TAPE & REEL AND TRAY DRAWINGS	11

ENVIRONMENTAL AND ABSOLUTE MAXIMUM RATINGS

(Voltages are with respect to GND)

			UNIT
V_I	Input voltage		16 V
T_A	Operating temperature range	Over V_I range	-40 to 85
T_{reflow}	Solder reflow temperature	Surface temperature of module body	260 ⁽¹⁾ °C
T_{stg}	Storage temperature		-55 to 125
	Mechanical shock	Per Mil-STD-883D, Method 2002.3, 1 msec, 1/2 sine, mounted	275 G
	Mechanical vibration	Mil-STD-883D, Method 2007.2, 20-2000 Hz	10
	Weight		3.9 grams
MTBF	Reliability	Per Telcordia SR-332, 50% stress, $T_A = 40^\circ\text{C}$, ground benign	13.3 10 ⁶ Hr
	Flammability	Meets UL94V-O	

(1) During reflow do not elevate peak temperature of the module or internal components above the stated maximum.

ELECTRICAL CHARACTERISTICS

PTD08A210W

$T_A = 25^\circ\text{C}$, $F_{\text{SW}} = 750\text{kHz}$, $V_I = 12\text{V}$, $V_O = 1.2\text{V}$, $C_{\text{IN}1} = 330\ \mu\text{F}$, $C_{\text{IN}2} = 22\ \mu\text{F}$ ceramic, $C_{\text{O}1} = 47\ \mu\text{F}$ ceramic, $C_{\text{O}2} = 330\ \mu\text{F}$, $I_{\text{O}} = I_{\text{O(max)}}$ (unless otherwise stated)

PARAMETER		TEST CONDITIONS		PTD08A210W			UNIT
				MIN	TYP	MAX	
I_{O}	Output current	Over V_{O} range	25°C, natural convection		0	10	A
V_{I}	Input voltage range	Over I_{O} range		4.75	14	V	
$V_{\text{O(ADJ)}}$	Output voltage adjust range	Over I_{O} range		0.7	3.6 ⁽¹⁾	V	
η	Efficiency	$I_{\text{O}} = 10\text{A}$, $f_{\text{s}} = 750\text{kHz}$	$V_{\text{O}} = 3.3\text{V}$	92.0%			
			$V_{\text{O}} = 2.5\text{V}$	90.4%			
			$V_{\text{O}} = 1.8\text{V}$	88.4%			
			$V_{\text{O}} = 1.2\text{V}$	84.7%			
			$V_{\text{O}} = 0.8\text{V}$	80.0%			
V_{OPP}	V_{O} Ripple (peak-to-peak)	20-MHz bandwidth		11		mV _{PP}	
I_{B}	Bias current	PWM & SRE to AGND	Standby	6		mA	
V_{IH}	High-level input voltage	SRE & PWM input levels		2.0	5.5	V	
V_{IL}	Low-level input voltage			0.8			
	PWM input	Frequency range		500 ⁽¹⁾	1000	kHz	
		Pulse width limits		20		ns	
	TEMP output	Range		-40	125	°C	
		Accuracy, $-40^\circ\text{C} \leq T_A \leq 85^\circ\text{C}$		-5	5	°C	
		Slope		10		mV/°C	
		Offset, $T_A = 25^\circ\text{C}$		720		mV	
V_{OH}	FAULT output	High-level output voltage, $I_{\text{FAULT}} = 4\text{mA}$		2.7	3.3	V	
V_{OL}		Low-level output voltage, $I_{\text{FAULT}} = 4\text{mA}$		0	0.6		
I_{LIM}		Overcurrent threshold; Reset, followed by auto-recovery		15 ⁽²⁾		A	
	IOUT output	Range		0.15	3.5	V	
		Gain, $3\text{A} \leq I_{\text{O}} \leq 10\text{A}$		188	200	212	mV/A
		Offset, $I_{\text{O}} = 0\text{A}$, $V_{\text{O}} = 1.2\text{V}$		0	0.3	0.6	V
		Output Impedance		10		k Ω	
C_{I}	External input capacitance	Nonceramic		330 ⁽³⁾		μF	
		Ceramic		22 ⁽³⁾			
C_{O}	External output capacitance	Capacitance Value	Nonceramic	330 ⁽⁴⁾	5000 ⁽⁵⁾	μF	
			Ceramic	47 ⁽⁴⁾			
		Equivalent series resistance (non-ceramic)		1 ⁽⁶⁾		m Ω	

- (1) When operating at 12V input and 500kHz, V_{O} is limited to $\leq 2.0\text{V}$.
- (2) The current limit threshold is the sum of I_{O} and the peak inductor ripple current.
- (3) A 22 μF ceramic input capacitor is required for proper operation. An additional 330 μF bulk capacitor rated for a minimum of 500mA rms of ripple current is recommended. When operating at frequencies > 500kHz the 22 μF ceramic capacitor is only recommended. Refer to the UCD9240 controller datasheet and user interface for application specific capacitor specifications.
- (4) A 47 μF ceramic output capacitor is required for basic operation. An additional 330 μF bulk capacitor is recommended for improved transient response. Refer to the UCD9240 controller datasheet and user interface for application specific capacitor specifications.
- (5) 5,000 μF is the calculated maximum output capacitance given a 1V/msec output voltage rise time. Additional capacitance or increasing the output voltage rise rate may trigger the overcurrent threshold at start-up. Refer to the UCD9240 controller datasheet and user interface for application specific capacitor specifications.
- (6) This is the minimum ESR for all non-ceramic output capacitance. Refer to the UCD9240 controller datasheet and user interface for application specific capacitor specifications.

TERMINAL FUNCTIONS

TERMINAL		DESCRIPTION
NAME	NO.	
V _{IN}	1, 2	The positive input voltage power node to the module, which is referenced to common GND.
PGND	3, 7, 8, 13, 14	The common ground connection for the V _I and V _O power connections.
V _{OUT}	15, 16	The regulated positive power output with respect to GND.
I _{SENSE}	11	Current sense output. The voltage level on this pin represents the average output current of the module.
PWM	4	The PWM input pin. It is a high impedance digital input that accepts 3.3-V or 5-V logic level signals up to 1 MHz.
FF	6	Current limit fault flag. The Fault signal is a 3.3-V digital output which is latched high after an over-current condition. The Fault is reset after a complete PWM cycle without an over-current condition (falling edge of the PWM).
SRE	5	Synchronous Rectifier Enable. This pin is a high impedance digital input. A 3.3 V or 5 V logic level signals is used to enable the synchronous rectifier switch. When this signal is high, the module will source and sink output current. When this signal is low, the module will only source current.
AGND	9, 10	Analog ground return. It is the 0 V _{dc} reference for the control inputs.
T _{SENSE}	12	Temperature sense output. The voltage level on this pin represents the temperature of the module.
Thermal Pad		This pad is electrically connected to PGND and is the primary thermal conduction cooling path for the module. This pad should be soldered to a grounded copper pad on the host board. For optimum cooling performance, the grounded copper pad should also be tied with multiple vias to the host board internal ground plane. See the Land Pattern drawing for package ECY for recommended pad dimensions.

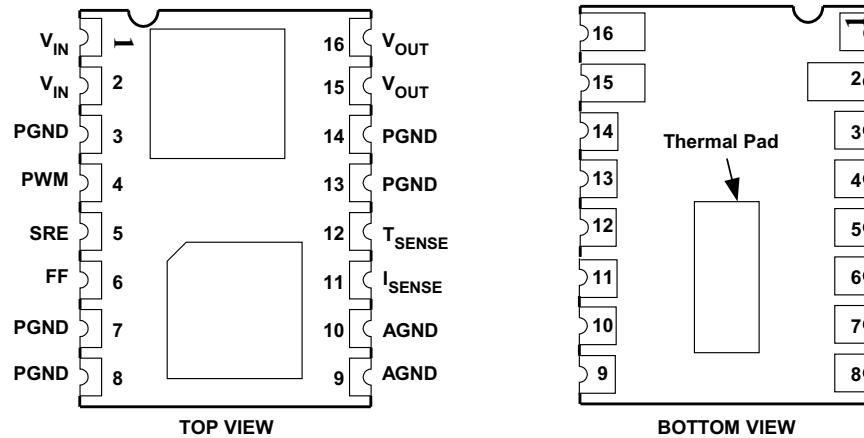

TYPICAL CHARACTERISTICS ($V_I = 12\text{ V}$)
(1)(2)

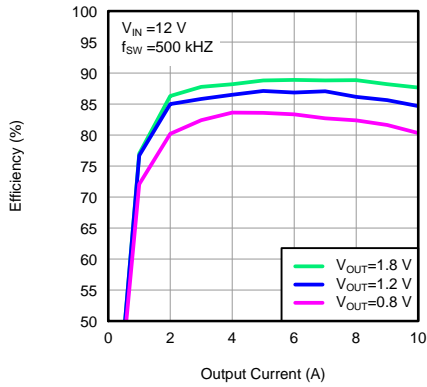

Figure 1. Efficiency

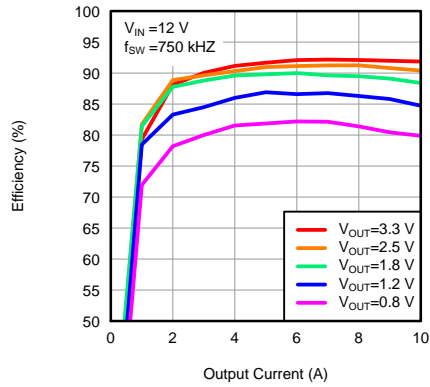

Figure 2. Efficiency

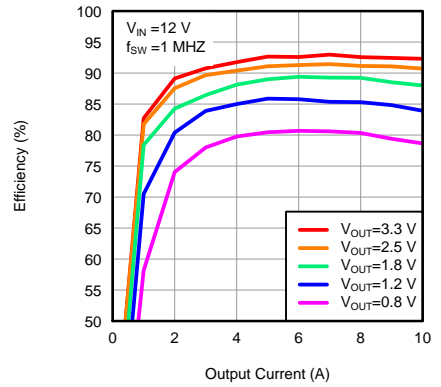

Figure 3. Efficiency

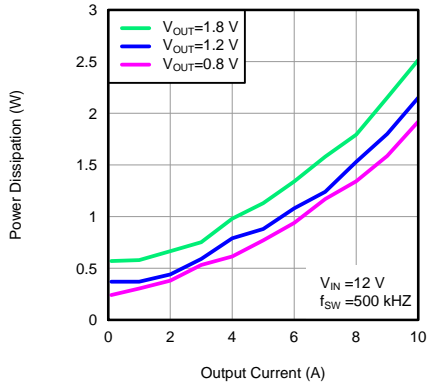

Figure 4. Power Dissipation

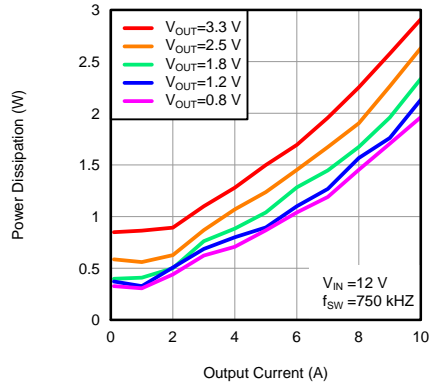

Figure 5. Power Dissipation

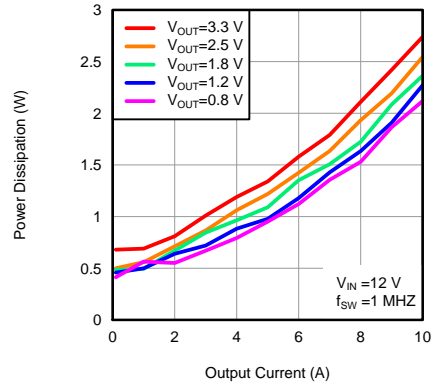

Figure 6. Power Dissipation

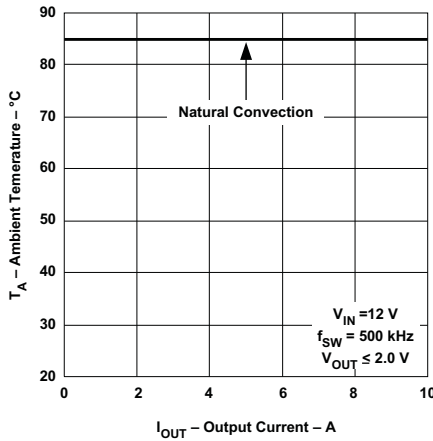

Figure 7. Safe Operating Area

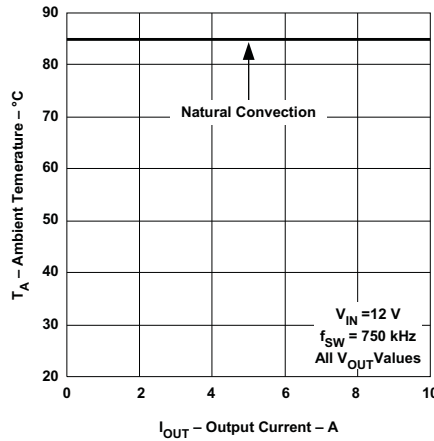

Figure 8. Safe Operating Area

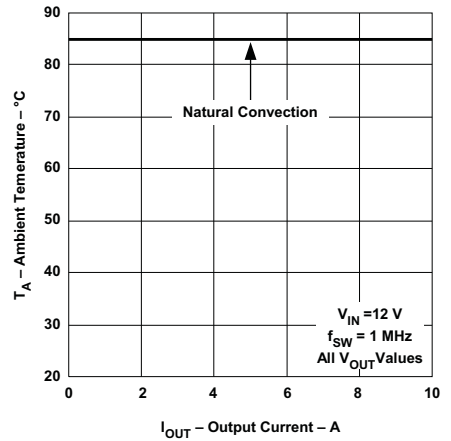

Figure 9. Safe Operating Area

- (1) The electrical characteristic data (Figure 1 through Figure 6) has been developed from actual products tested at 25°C. This data is considered typical for the converter.
- (2) The temperature derating curves (Figure 7 through Figure 9) represent the conditions at which internal components are at or below the manufacturer's maximum operating temperatures. Derating limits apply to modules soldered directly to a 100-mm x 100-mm, double-sided PCB with 2-oz. copper. See the Safe Operating Area application section of this datasheet.

TYPICAL CHARACTERISTICS ($V_I = 5\text{ V}$)
(1)(2)

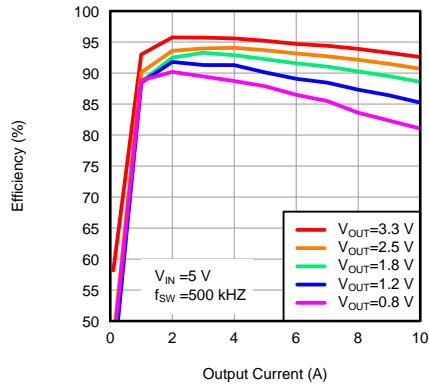

Figure 10. Efficiency

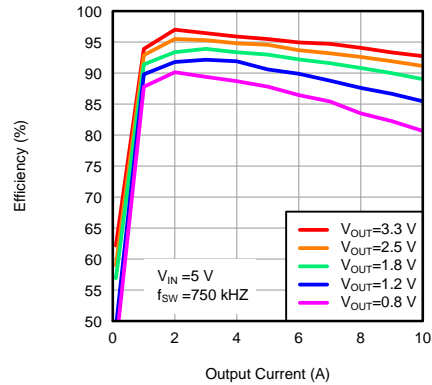

Figure 11. Efficiency

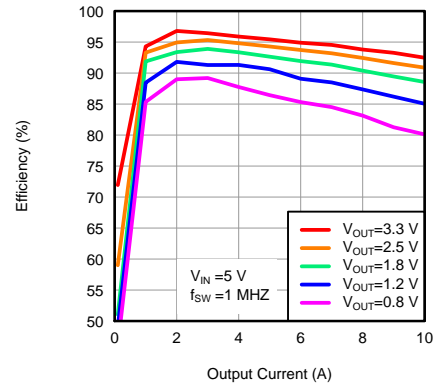

Figure 12. Efficiency

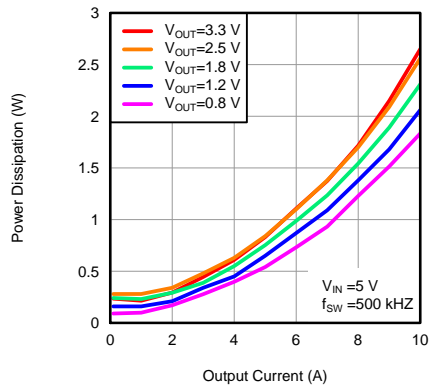

Figure 13. Power Dissipation

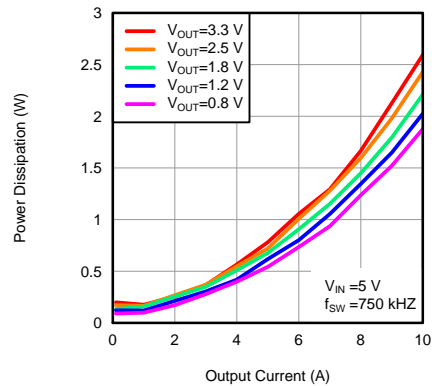

Figure 14. Power Dissipation

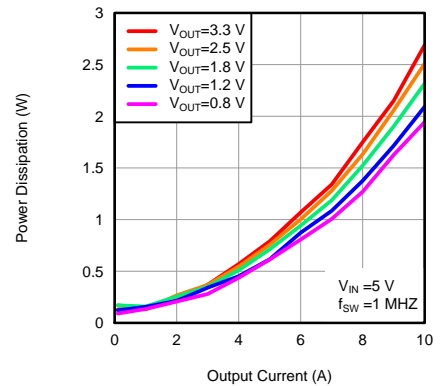

Figure 15. Power Dissipation

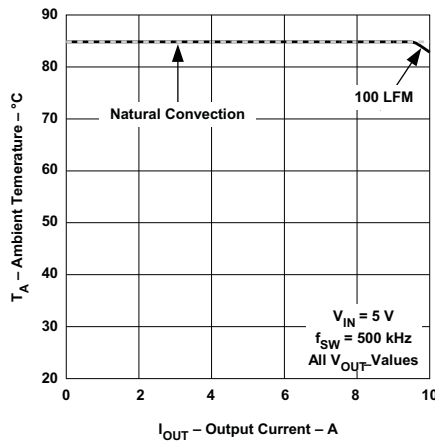

Figure 16. Safe Operating Area

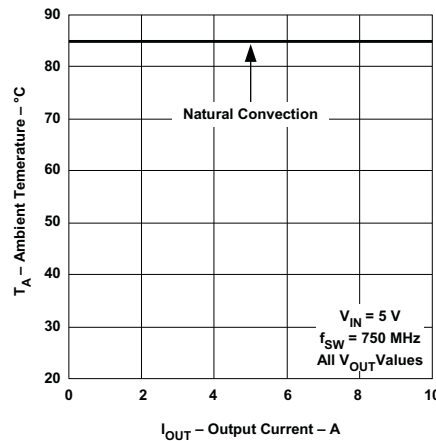

Figure 17. Safe Operating Area

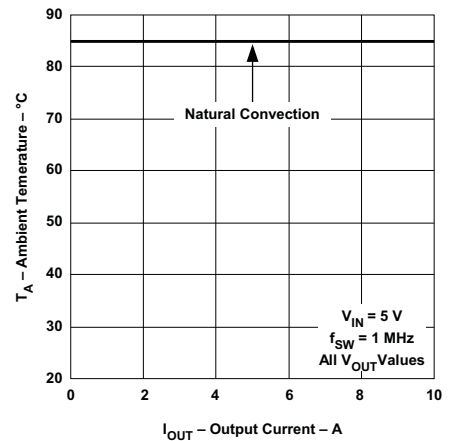

Figure 18. Safe Operating Area

- (1) The electrical characteristic data (Figure 10 through Figure 15) has been developed from actual products tested at 25°C. This data is considered typical for the converter.
- (2) The temperature derating curves (Figure 16 through Figure 18) represent the conditions at which internal components are at or below the manufacturer's maximum operating temperatures. Derating limits apply to modules soldered directly to a 100-mm x 100-mm, double-sided PCB with 2-oz. copper. See the Safe Operating Area application section of this datasheet.

TYPICAL CHARACTERISTICS

CURRENT SENSE OUTPUT
VS
OUTPUT CURRENT

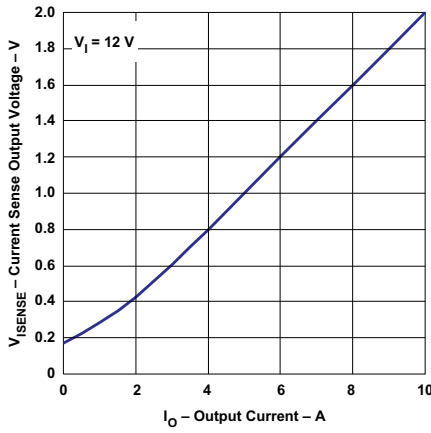

Figure 19.

CURRENT SENSE OUTPUT
VS
OUTPUT CURRENT

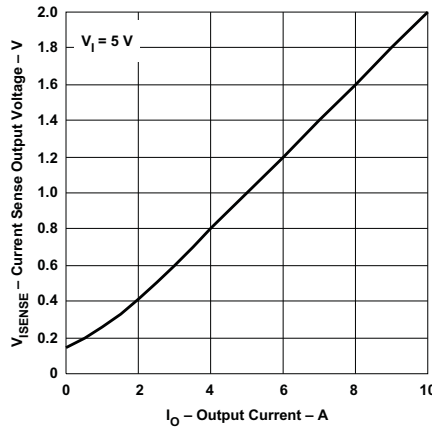

Figure 20.

TEMPERATURE SENSE
VS
JUNCTION TEMPERATURE

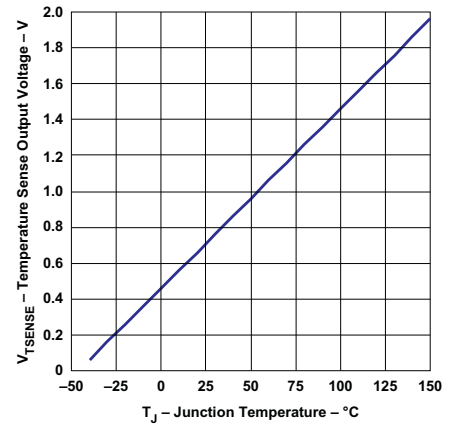

Figure 21.

APPLICATION INFORMATION

Digital Power

Figure 22 shows the UCD9220 power supply controller working with a single PTD08A210W, digital powertrain module. The loop for the power supply is created by the voltage output feeding into the Error ADC differential inputs, and completed by the DPWM output feeding the PTD08A210W module. A second stand-alone power stage can be controlled by the UCD9220 controller. The PTD08A210W's output cannot be paralleled. It can only be used as a single stand-alone 10-A module.

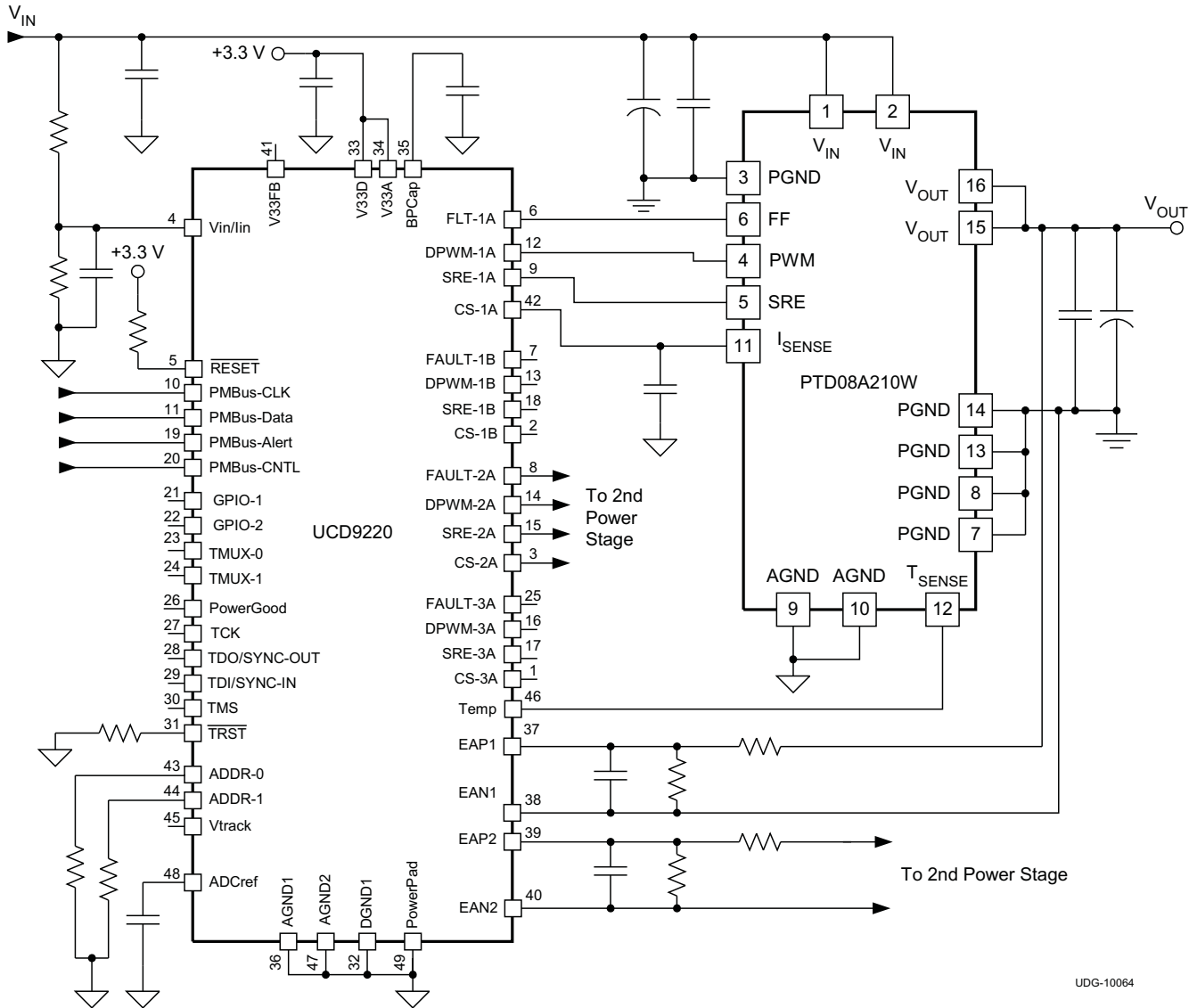

Figure 22. Typical Dual-Output Application Schematic

Note: A low dropout linear regulator such as the TI TPS715A33 can provide the 3.3-V bias power to the UCD9220.

Fusion Digital Power Graphical User Interface (GUI)

When using the UCD92x0 digital controller along with digital PowerTrain modules to design a digital power system, several internal parameters of the modules are required to run the Fusion Digital Power Designer GUI. See the plant parameters below for the PTD08A210W digital PowerTrain modules.

Table 1. PTD08A210W Plant Parameters

PTD08A210W Plant Parameters			
L (μH)	DCR ($\text{m}\Omega$)	$R_{\text{DS(on)-high}}$ ($\text{m}\Omega$)	$R_{\text{DS(on)-low}}$ ($\text{m}\Omega$)
0.47	2.6	15.5	6.5

Internal output capacitance is present on the digital PowerTrain modules themselves. When using the GUI interface this capacitance information must be included along with any additional external capacitance. See the capacitor parameters below for the PTD08A210W digital PowerTrain modules.

Table 2. PTD08A210W Capacitor Parameters

PTD08A210W Capacitor Parameters			
C (μF)	ESR ($\text{m}\Omega$)	ESL (nH)	Quantity
47	1.5	2.5	1

TAPE & REEL

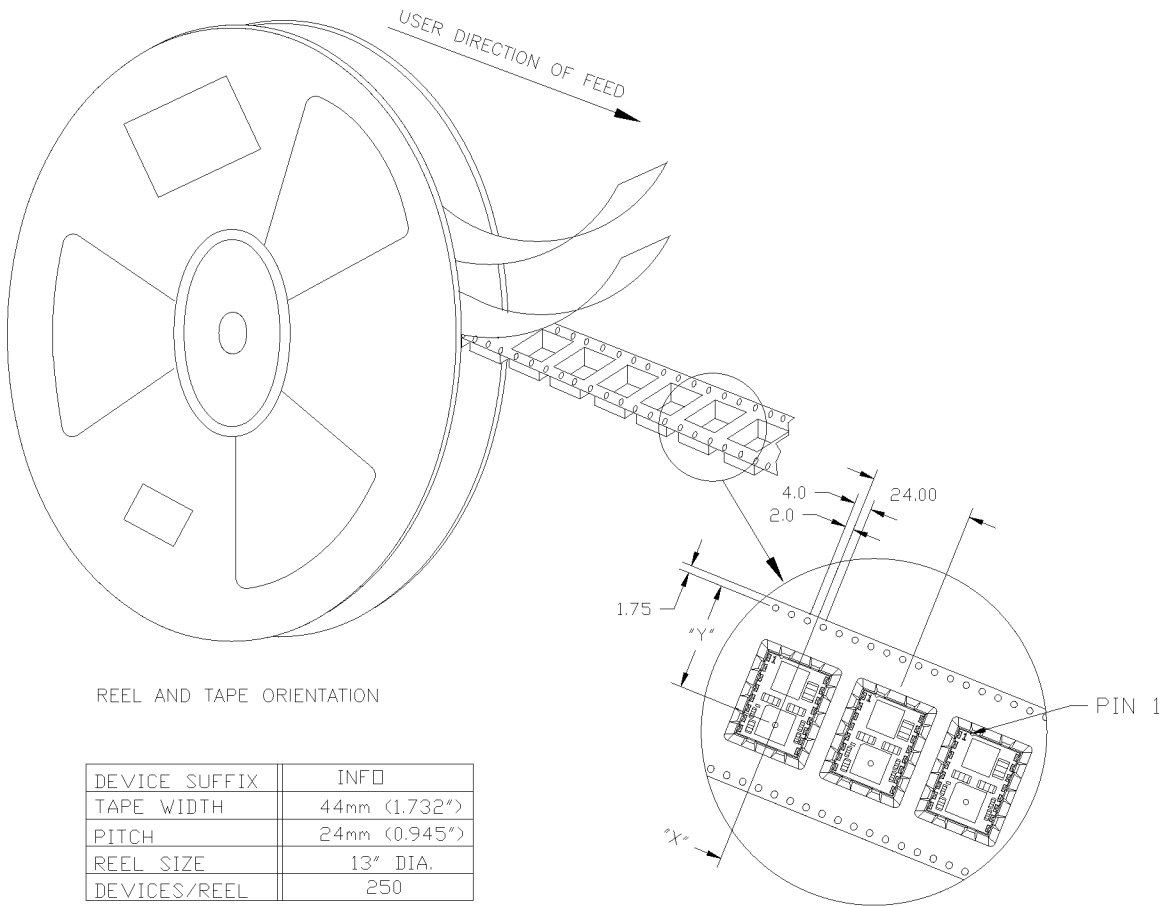

REEL AND TAPE ORIENTATION

DEVICE SUFFIX	INFO
TAPE WIDTH	44mm (1.732")
PITCH	24mm (0.945")
REEL SIZE	13" DIA.
DEVICES/REEL	250

PTDXXXXX	"X"	"Y"
PTD08A210	0mm	25.28mm

TRAY

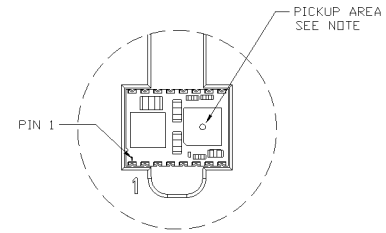
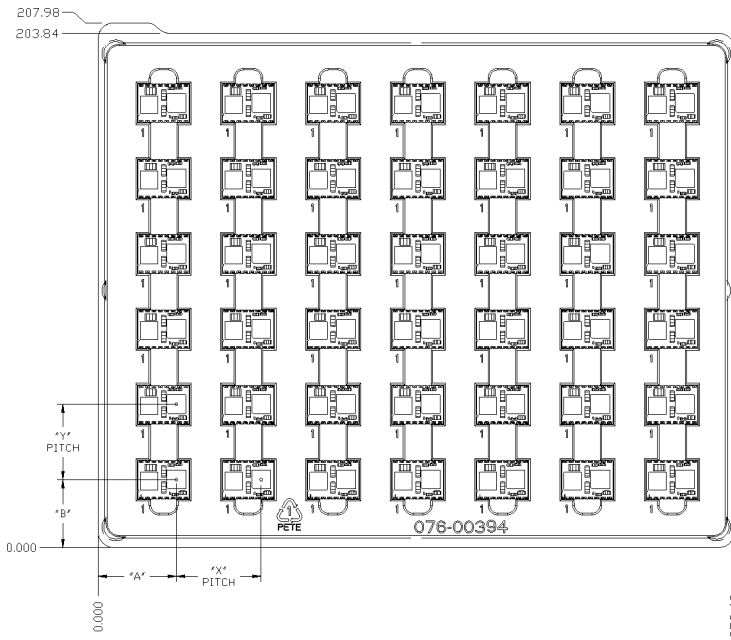

NOTE: THE INDUCTOR IS USED TO PICK AND PLACE THE MODULE. IT'S LOCATION MAY VARY FROM PACKAGE STYLE. SEE PRODUCT TABLE

PTDXXXXXX	"A"	"B"	"X"	"Y"
PTD08A210	31.08	26.95	33.61	29.85

ALL DIMENSIONS ARE IN MILLIMETER.

DEVICES/TRAY	42
--------------	----

PACKAGING INFORMATION

Orderable part number	Status (1)	Material type (2)	Package Pins	Package qty Carrier	RoHS (3)	Lead finish/ Ball material (4)	MSL rating/ Peak reflow (5)	Op temp (°C)	Part marking (6)
PTD08A210WAC	Active	Production	DIP MODULE (ECY) 16	42 TIW TRAY	In-Work	Call TI	Level-3-260C-168 HR	-40 to 85	

(1) **Status:** For more details on status, see our [product life cycle](#).

(2) **Material type:** When designated, preproduction parts are prototypes/experimental devices, and are not yet approved or released for full production. Testing and final process, including without limitation quality assurance, reliability performance testing, and/or process qualification, may not yet be complete, and this item is subject to further changes or possible discontinuation. If available for ordering, purchases will be subject to an additional waiver at checkout, and are intended for early internal evaluation purposes only. These items are sold without warranties of any kind.

(3) **RoHS values:** Yes, No, RoHS Exempt. See the [TI RoHS Statement](#) for additional information and value definition.

(4) **Lead finish/Ball material:** Parts may have multiple material finish options. Finish options are separated by a vertical ruled line. Lead finish/Ball material values may wrap to two lines if the finish value exceeds the maximum column width.

(5) **MSL rating/Peak reflow:** The moisture sensitivity level ratings and peak solder (reflow) temperatures. In the event that a part has multiple moisture sensitivity ratings, only the lowest level per JEDEC standards is shown. Refer to the shipping label for the actual reflow temperature that will be used to mount the part to the printed circuit board.

(6) **Part marking:** There may be an additional marking, which relates to the logo, the lot trace code information, or the environmental category of the part.

Multiple part markings will be inside parentheses. Only one part marking contained in parentheses and separated by a "~" will appear on a part. If a line is indented then it is a continuation of the previous line and the two combined represent the entire part marking for that device.

Important Information and Disclaimer: The information provided on this page represents TI's knowledge and belief as of the date that it is provided. TI bases its knowledge and belief on information provided by third parties, and makes no representation or warranty as to the accuracy of such information. Efforts are underway to better integrate information from third parties. TI has taken and continues to take reasonable steps to provide representative and accurate information but may not have conducted destructive testing or chemical analysis on incoming materials and chemicals. TI and TI suppliers consider certain information to be proprietary, and thus CAS numbers and other limited information may not be available for release.

In no event shall TI's liability arising out of such information exceed the total purchase price of the TI part(s) at issue in this document sold by TI to Customer on an annual basis.

ECY (R-PDSS-T16)

SINGLE SIDED MODULE

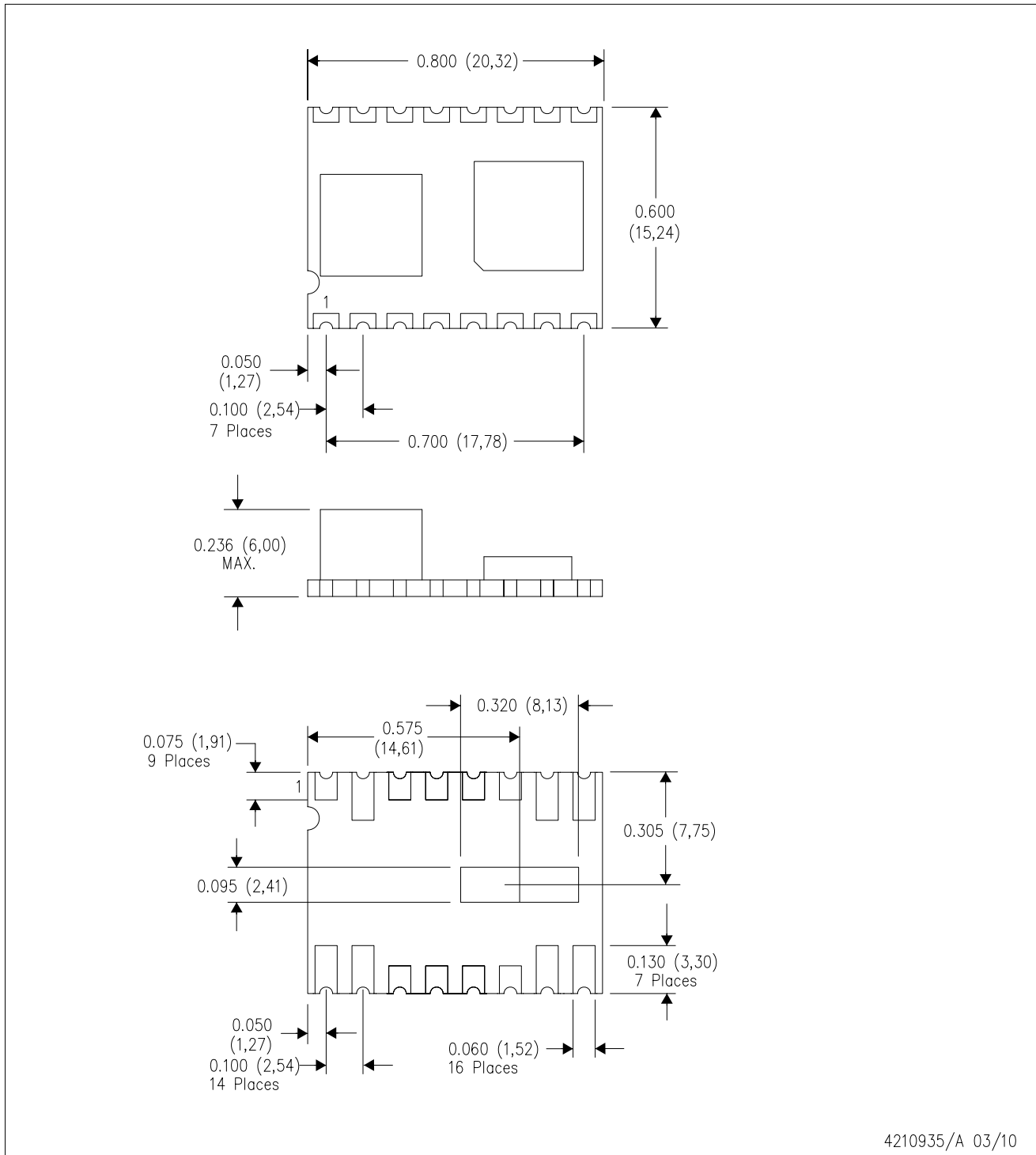

4210935/A 03/10

- NOTES:
- A. All linear dimensions are in inches (mm).
 - B. This drawing is subject to change without notice.
 - C. 2 place decimals are ± 0.030 ($\pm 0,76$ mm).
 - D. 3 place decimals are ± 0.010 ($\pm 0,25$ mm).

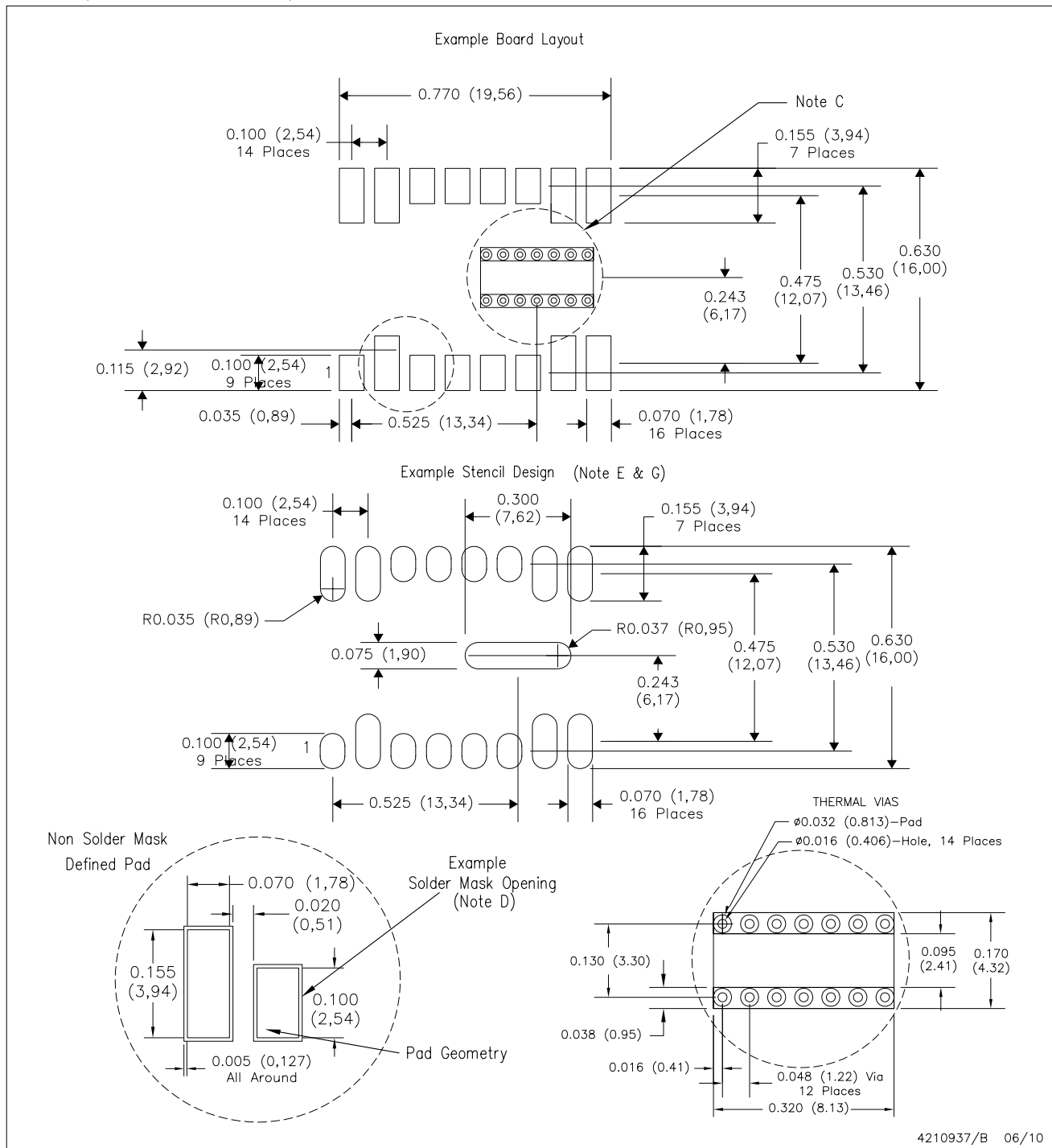

4210937/B 06/10

- NOTES:
- A. All linear dimensions are in inches & millimeters.
 - B. This drawing is subject to change without notice.
 - C. This package is designed to be soldered to a thermal pad on the board. This pad must be at ground potential and be connected to an internal ground plane with multiple thermal vias.
 - D. Customers should contact their board fabrication site for minimum solder mask web tolerances between signal pads.
 - E. Laser cutting apertures with trapezoidal walls and also rounding corners will offer better paste release. Customers should contact their board assembly site for stencil design recommendations. Refer to IPC 7525 for stencil design considerations.
 - F. Paste screen thickness: 0.006 (0,15).
 - G. 3 place decimals are ±0.010 (±0.25)

IMPORTANT NOTICE AND DISCLAIMER

TI PROVIDES TECHNICAL AND RELIABILITY DATA (INCLUDING DATASHEETS), DESIGN RESOURCES (INCLUDING REFERENCE DESIGNS), APPLICATION OR OTHER DESIGN ADVICE, WEB TOOLS, SAFETY INFORMATION, AND OTHER RESOURCES "AS IS" AND WITH ALL FAULTS, AND DISCLAIMS ALL WARRANTIES, EXPRESS AND IMPLIED, INCLUDING WITHOUT LIMITATION ANY IMPLIED WARRANTIES OF MERCHANTABILITY, FITNESS FOR A PARTICULAR PURPOSE OR NON-INFRINGEMENT OF THIRD PARTY INTELLECTUAL PROPERTY RIGHTS.

These resources are intended for skilled developers designing with TI products. You are solely responsible for (1) selecting the appropriate TI products for your application, (2) designing, validating and testing your application, and (3) ensuring your application meets applicable standards, and any other safety, security, regulatory or other requirements.

These resources are subject to change without notice. TI grants you permission to use these resources only for development of an application that uses the TI products described in the resource. Other reproduction and display of these resources is prohibited. No license is granted to any other TI intellectual property right or to any third party intellectual property right. TI disclaims responsibility for, and you fully indemnify TI and its representatives against any claims, damages, costs, losses, and liabilities arising out of your use of these resources.

TI's products are provided subject to [TI's Terms of Sale](#), [TI's General Quality Guidelines](#), or other applicable terms available either on [ti.com](#) or provided in conjunction with such TI products. TI's provision of these resources does not expand or otherwise alter TI's applicable warranties or warranty disclaimers for TI products. Unless TI explicitly designates a product as custom or customer-specified, TI products are standard, catalog, general purpose devices.

TI objects to and rejects any additional or different terms you may propose.

Copyright © 2025, Texas Instruments Incorporated

Last updated 10/2025