

SN54157, SN54LS157, SN54LS158, SN54S157, SN54S158, SN74157, SN74LS157, SN74LS158, SN74S157, SN74S158 QUADRUPLE 2-LINE TO 1-LINE DATA SELECTORS/MULTIPLEXERS

MARCH 1974 — REVISED MARCH 1988

- Buffered Inputs and Outputs
- Three Speed/Power Ranges Available

TYPES	TYPICAL AVERAGE PROPAGATION TIME	TYPICAL POWER DISSIPATION
'157	9 ns	150 mW
'LS157	9 ns	49 mW
'S157	5 ns	250 mW
'LS158	7 ns	24 mW
'S158	4 ns	195 mW

applications

- Expand Any Data Input Point
- Multiplex Dual Data Buses
- Generate Four Functions of Two Variables (One Variable Is Common)
- Source Programmable Counters

description

These monolithic data selectors/multiplexers contain inverters and drivers to supply full on-chip data selection to the four output gates. A separate strobe input is provided. A 4-bit word is selected from one of two sources and is routed to the four outputs. The '157, 'LS157, and 'S157 present true data whereas the 'LS158 and 'S158 present inverted data to minimize propagation delay time.

FUNCTION TABLE

STROBE \bar{G}	INPUTS		OUTPUT Y		
	SELECT \bar{A}/\bar{B}	A	B	'157, 'LS157, 'S157	'LS158 'S158
H	X	X	X	L	H
L	L	L	X	L	H
L	L	H	X	H	L
L	H	X	L	L	H
L	H	X	H	H	L

H = high level, L = low level, X = irrelevant

absolute maximum ratings over operating free-air temperature range (unless otherwise noted)

Supply voltage, V_{CC} (See Note 1)	7 V
Input voltage: '157, 'S158	5.5 V
'LS157, 'LS158	7 V
Operating free-air temperature range: SN54'	-55°C to 125°C
SN74'	0°C to 70°C
Storage temperature range	-65°C to 150°C

NOTE 1: Voltage values are with respect to network ground terminal.

SN54157, SN54LS157, SN54S157,
SN54LS158, SN54S158 . . . J OR W PACKAGE
SN74157 . . . N PACKAGE
SN74LS157, SN74S157,
SN74LS158, SN74S158 . . . D OR N PACKAGE

(TOP VIEW)

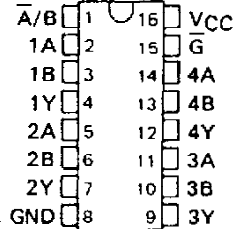

SN54LS157, SN54S157, SN54LS158,
SN54S158 . . . FK PACKAGE

(TOP VIEW)



NC - No internal connection

PRODUCTION DATA documents contain information current as of publication date. Products conform to specifications per the terms of Texas Instruments standard warranty. Production processing does not necessarily include testing of all parameters.



POST OFFICE BOX 655812 • DALLAS, TEXAS 75265

**SN54157, SN54LS157, SN54LS158, SN54S157, SN54S158,
SN74157, SN74LS157, SN74LS158, SN74S157, SN74S158
QUADRUPLE 2-LINE TO 1-LINE DATA SELECTORS/MULTIPLEXERS**

logic symbols†

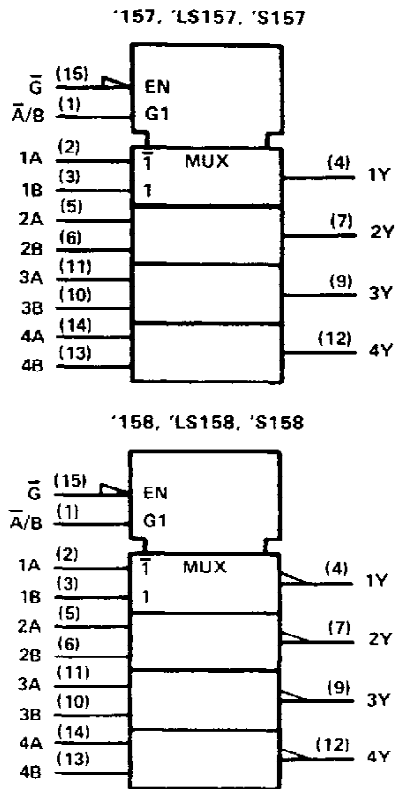

logic diagram (positive logic)



† These symbols are in accordance with ANSI/IEEE Std. 91-1984 and IEC Publication 617-12.

Pin numbers shown are for D, J, N, and W packages.

schematics of inputs and outputs



TEXAS
INSTRUMENTS

POST OFFICE BOX 635012 • DALLAS, TEXAS 75265

SN54LS157, SN54LS158, SN54S157, SN54S158, SN74LS157, SN74LS158, SN74S157, SN74S158 QUADRUPLE 2-LINE TO 1-LINE DATA SELECTORS/MULTIPLEXERS

logic diagrams (positive logic)

schematics of inputs and outputs

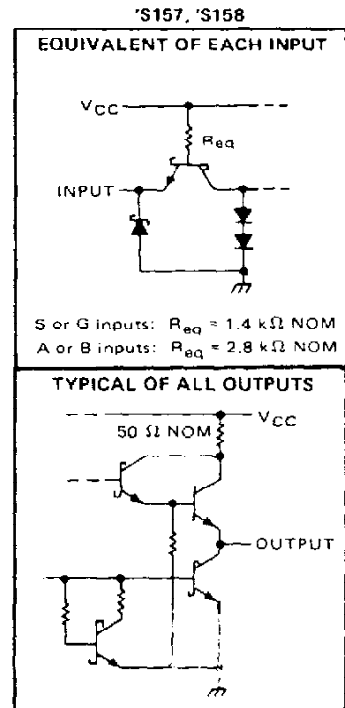
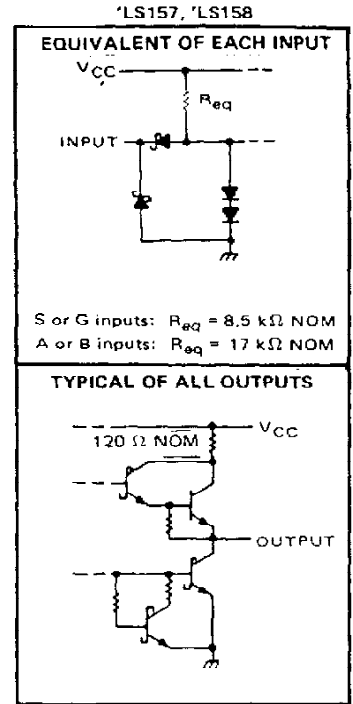
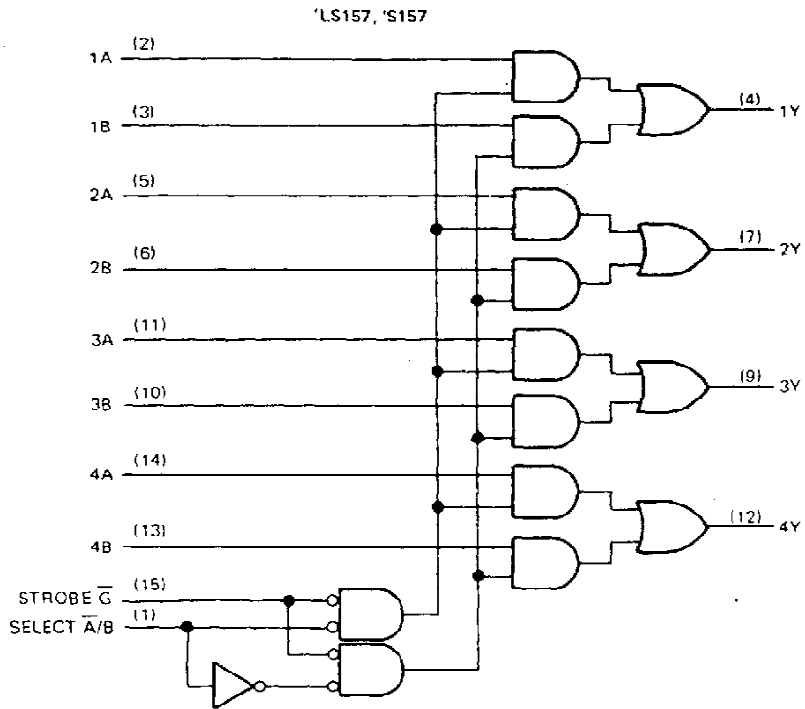

Pin numbers shown are for D, J, N, and W packages.

**TEXAS
INSTRUMENTS**

POST OFFICE BOX 655012 • DALLAS, TEXAS 75265

SN54157, SN74157 QUADRUPLE 2-LINE TO 1-LINE DATA SELECTORS/MULTIPLEXERS

recommended operating conditions

	SN54157			SN74157			UNIT
	MIN	NOM	MAX	MIN	NOM	MAX	
Supply voltage, V_{CC}	4.5	5	5.5	4.75	5	5.25	V
High-level output current, I_{OH}			-800			-800	μ A
Low-level output current, I_{OL}			16			16	mA
Operating free-air temperature, T_A	-55		125	0		70	$^{\circ}$ C

electrical characteristics over recommended operating free-air temperature range (unless otherwise noted)

PARAMETER	TEST CONDITIONS†	SN54157			SN74157			UNIT
		MIN	TYP‡	MAX	MIN	TYP‡	MAX	
V_{IH} High-level input voltage		2			2			V
V_{IL} Low-level input voltage				0.8			0.8	V
V_{IK} Input clamp voltage	$V_{CC} = \text{MIN}$, $I_I = -12 \text{ mA}$			-1.5			-1.5	V
V_{OH} High-level output voltage	$V_{CC} = \text{MIN}$, $V_{IH} = 2 \text{ V}$, $V_{IL} = 0.8 \text{ V}$, $I_{OH} = -800 \mu\text{A}$	2.4	3.4		2.4	3.4		V
V_{OL} Low-level output voltage	$V_{CC} = \text{MIN}$, $V_{IH} = 2 \text{ V}$, $V_{IL} = 0.8 \text{ V}$, $I_{OL} = 16 \text{ mA}$		0.2	0.4		0.2	0.4	V
I_I Input current at maximum input voltage	$V_{CC} = \text{MAX}$, $V_I = 5.5 \text{ V}$			1			1	mA
I_{IH} High-level input current	$V_{CC} = \text{MAX}$, $V_I = 2.4 \text{ V}$			40			40	μ A
I_{IL} Low level input current	$V_{CC} = \text{MAX}$, $V_I = 0.4 \text{ V}$			-1.6			-1.6	mA
I_{OS} Short-circuit output current‡	$V_{CC} = \text{MAX}$	-20		-55	-18		-55	mA
I_{CC} Supply current	$V_{CC} = \text{MAX}$. See Note 2		30	48		30	48	mA

†For conditions shown as MIN or MAX, use the appropriate value specified under recommended operating conditions.

‡All typical values are at $V_{CC} = 5 \text{ V}$, $T_A = 25^{\circ}\text{C}$.

§Not more than one output should be shorted at a time and duration of short-circuit should not exceed one second.

NOTE 2: I_{CC} is measured with 4.5 V applied to all inputs and all outputs open.

switching characteristics, $V_{CC} = 5 \text{ V}$, $T_A = 25^{\circ}\text{C}$

PARAMETER¶	FROM (INPUT)	TEST CONDITIONS	MIN	TYP	MAX	UNIT
t_{PLH}	Data	$C_L = 15 \mu\text{F}$, $R_L = 400 \Omega$, See Note 3		9	14	ns
t_{PHL}				9	14	
t_{PLH}	Strobe \bar{G}			13	20	ns
t_{PHL}				14	21	
t_{PLH}	Select \bar{A}/\bar{B}			15	23	ns
t_{PHL}				18	27	

¶ t_{PLH} = propagation delay time, low-to-high-level output

t_{PHL} = propagation delay time, high-to-low-level output

NOTE 3: Load circuits and voltage waveforms are shown in Section 1.

TEXAS
INSTRUMENTS

POST OFFICE BOX 655012 • DALLAS, TEXAS 75265

SN54LS157, SN54LS158, SN74LS157, SN74LS158 QUADRUPLE 2-LINE TO 1-LINE DATA SELECTORS/MULTIPLEXERS

recommended operating conditions

	SN54LS'			SN74LS'			UNIT
	MIN	NOM	MAX	MIN	NOM	MAX	
V _{CC} Supply voltage	4.5	5	5.5	4.75	5	5.25	V
I _{OH} High-level output current			-400			-400	μA
I _{OL} Low-level output current			4			8	mA
T _A Operating free-air temperature	-55		125	0		70	°C

electrical characteristics over recommended operating free-air temperature range (unless otherwise noted)

PARAMETER	TEST CONDITIONS†	SN54LS'			SN74LS'			UNIT
		MIN	TYP‡	MAX	MIN	TYP‡	MAX	
V _{IH} High-level input voltage		2			2			V
V _{IL} Low-level input voltage				0.7			0.8	V
V _{IK} Input clamp voltage	V _{CC} = MIN, I _I = -18 mA			-1.5			-1.5	V
V _{OH} High-level output voltage	V _{CC} = MIN, V _{IH} = 2 V, V _{IL} = MAX, I _{OH} = -400 μA	2.5	3.4		2.7	3.4		V
V _{OL} Low-level output voltage	V _{CC} = MIN, V _{IH} = 2 V, V _{IL} = MAX	I _{OL} = 4 mA		0.25	0.4	0.25	0.4	V
		I _{OL} = 8 mA				0.35	0.5	
I _I Input current at maximum input voltage	\bar{A}/B or \bar{G}	V _{CC} = MAX, V _I = 7 V				0.2		0.2
	A or B							
I _{IH} High-level input current	\bar{A}/B or \bar{G}	V _{CC} = MAX, V _I = 2.7 V				40		40
	A or B							
I _{IL} Low-level input current	\bar{A}/B or \bar{G}	V _{CC} = MAX, V _I = 0.4 V				-0.8		-0.8
	A or B							
I _{OS} Short-circuit output current§	V _{CC} = MAX	-20	-100	-20	-100			mA
I _{CC} Supply current	V _{CC} = MAX, See Note 2		'LS157	9.7	16	9.7	16	mA
			'LS158	4.8	8	4.8	8	
	V _{CC} = MAX, All A inputs at 4.5 V, All other inputs at 0 V		'LS158	6.5	11	6.5	11	

† For conditions shown as MIN or MAX, use the appropriate value specified under recommended operating conditions.

‡ All typical values are at V_{CC} = 5 V, T_A = 25°C.

§ Not more than one output should be shorted at a time and duration of short circuit should not exceed one second.

NOTE 2: I_{CC} is measured with 4.5 V applied to all inputs and all outputs open.

switching characteristics, V_{CC} = 5 V, T_A = 25°C

PARAMETER¶	FROM (INPUT)	TEST CONDITIONS	'LS157			'LS158			UNIT
			MIN	TYP	MAX	MIN	TYP	MAX	
t _{PLH}	Data	C _L = 15 pF, R _L = 2 kΩ, See Note 3	9	14		7	12	ns	
t _{PHL}			9	14		10	15		
t _{PLH}	Strobe \bar{G}		13	20		11	17	ns	
t _{PHL}			14	21		18	24		
t _{PLH}	Select \bar{A}/B		15	23		13	20	ns	
t _{PHL}			18	27		16	24		

¶ t_{PLH} = propagation delay time, low-to-high-level output

t_{PHL} = propagation delay time, high-to-low-level output

NOTE 3: Load circuits and voltage diagrams are shown in Section 1.

**TEXAS
INSTRUMENTS**

POST OFFICE BOX 655012 • DALLAS, TEXAS 75265

SN54S157, SN54S158, SN74S157, SN74S158 QUADRUPLE 2-LINE TO 1-LINE DATA SELECTORS/MULTIPLEXERS

recommended operating conditions

	SN54S157 SN54S158			SN74S157 SN74S158			UNIT
	MIN	NOM	MAX	MIN	NOM	MAX	
Supply voltage, V_{CC}	4.5	5	5.5	4.75	5	5.25	V
High-level output current, I_{OH}			-1			-1	mA
Low-level output current, I_{OL}			20			20	mA
Operating free-air temperature, T_A	-55		125	0		70	$^{\circ}$ C

electrical characteristics over recommended operating free-air temperature range (unless otherwise noted)

PARAMETER	TEST CONDITIONS†	SN54S157 SN74S157			SN54S158 SN74S158			UNIT
		MIN	TYP‡	MAX	MIN	TYP‡	MAX	
V_{IH} High-level input voltage		2			2			V
V_{IL} Low-level input voltage				0.8			0.8	V
V_{IK} Input clamp voltage	$V_{CC} = \text{MIN}, I_I = -18 \text{ mA}$			-1.2			-1.2	V
V_{OH} High-level output voltage	$V_{CC} = \text{MIN}, V_{IH} = 2 \text{ V},$ $V_{IL} = 0.8 \text{ V}, I_{OH} = -1 \text{ mA}$	Series 54S	2.5	3.4	Series 74S	2.5	3.4	V
		Series 74S	2.7	3.4	Series 74S	2.7	3.4	
V_{OL} Low-level output voltage	$V_{CC} = \text{MIN}, V_{IH} = 2 \text{ V},$ $V_{IL} = 0.8 \text{ V}, I_{OL} = 20 \text{ mA}$			0.5			0.5	V
I_I Input current at maximum input voltage	$V_{CC} = \text{MAX}, V_I = 5.5 \text{ V}$			1			1	mA
I_{IH} High-level input current	$\overline{A/B}$ or \overline{G}			100			100	μ A
	A or B			50			50	
I_{IL} Low-level input current	$\overline{A/B}$ or \overline{G}			-4			-4	mA
	A or B			-2			-2	
I_{OS} Short-circuit output current §	$V_{CC} = \text{MAX}$			-40			-100	mA
I_{CC} Supply current	$V_{CC} = \text{MAX},$ All inputs at 4.5 V, See Note 2			50			39	mA
	$V_{CC} = \text{MAX},$ A inputs at 4.5 V, B,G,S, inputs at 0 V, See Note 2						81	

† For conditions shown as MIN or MAX, use the appropriate value specified under recommended operating conditions.

‡ All typical values are at $V_{CC} = 5 \text{ V}, T_A = 25^{\circ}\text{C}$.

§ Not more than one output should be shorted at a time, and duration of the short-circuit should not exceed one second.

Note 2: I_{CC} is measured with all outputs open.

switching characteristics, $V_{CC} = 5 \text{ V}, T_A = 25^{\circ}\text{C}$

PARAMETER ¶	FROM (INPUT)	TEST CONDITIONS	SN54S157 SN74S157			SN54S158 SN74S158			UNIT
			MIN	TYP	MAX	MIN	TYP	MAX	
t_{PLH}	Data	$C_L = 15 \text{ pF},$ $R_L = 280 \Omega,$ See Note 3	5	7.5		4	6	ns	
t_{PHL}			4.5	6.5		4	6		
t_{PLH}	Strobe \overline{G}		8.5	12.5		6.5	11.5	ns	
t_{PHL}			7.5	12		7	12		
t_{PLH}	Select $\overline{A/B}$		9.5	15		8	12	ns	
t_{PHL}			9.5	15		8	12		

¶ t_{PLH} = propagation delay time, low-to-high-level output

¶ t_{PHL} = propagation delay time, high-to-low-level output

NOTE 3: Load circuits and voltage waveforms are shown in Section 1.

TEXAS
INSTRUMENTS

POST OFFICE BOX 655012 • DALLAS, TEXAS 75265

PACKAGING INFORMATION

Orderable part number	Status (1)	Material type (2)	Package Pins	Package qty Carrier	RoHS (3)	Lead finish/ Ball material (4)	MSL rating/ Peak reflow (5)	Op temp (°C)	Part marking (6)
76002012A	Active	Production	LCCC (FK) 20	55 TUBE	No	SNPB	N/A for Pkg Type	-55 to 125	76002012A SNJ54LS 157FK
7600201EA	Active	Production	CDIP (J) 16	25 TUBE	No	SNPB	N/A for Pkg Type	-55 to 125	7600201EA SNJ54LS157J
7600201FA	Active	Production	CFP (W) 16	25 TUBE	No	SNPB	N/A for Pkg Type	-55 to 125	7600201FA SNJ54LS157W
76033012A	Active	Production	LCCC (FK) 20	55 TUBE	No	SNPB	N/A for Pkg Type	-55 to 125	76033012A SNJ54LS 158FK
7603301EA	Active	Production	CDIP (J) 16	25 TUBE	No	SNPB	N/A for Pkg Type	-55 to 125	7603301EA SNJ54LS158J
JM38510/07903BEA	Active	Production	CDIP (J) 16	25 TUBE	No	SNPB	N/A for Pkg Type	-55 to 125	JM38510/ 07903BEA
JM38510/07903BEA.A	Active	Production	CDIP (J) 16	25 TUBE	No	SNPB	N/A for Pkg Type	-55 to 125	JM38510/ 07903BEA
JM38510/07903BFA	Active	Production	CFP (W) 16	25 TUBE	No	SNPB	N/A for Pkg Type	-55 to 125	JM38510/ 07903BFA
JM38510/07903BFA.A	Active	Production	CFP (W) 16	25 TUBE	No	SNPB	N/A for Pkg Type	-55 to 125	JM38510/ 07903BFA
JM38510/30903B2A	Active	Production	LCCC (FK) 20	55 TUBE	No	SNPB	N/A for Pkg Type	-55 to 125	JM38510/ 30903B2A
JM38510/30903B2A.A	Active	Production	LCCC (FK) 20	55 TUBE	No	SNPB	N/A for Pkg Type	-55 to 125	JM38510/ 30903B2A
JM38510/30903BEA	Active	Production	CDIP (J) 16	25 TUBE	No	SNPB	N/A for Pkg Type	-55 to 125	JM38510/ 30903BEA
JM38510/30903BEA.A	Active	Production	CDIP (J) 16	25 TUBE	No	SNPB	N/A for Pkg Type	-55 to 125	JM38510/ 30903BEA
JM38510/30903BFA	Active	Production	CFP (W) 16	25 TUBE	No	SNPB	N/A for Pkg Type	-55 to 125	JM38510/ 30903BFA
JM38510/30903BFA.A	Active	Production	CFP (W) 16	25 TUBE	No	SNPB	N/A for Pkg Type	-55 to 125	JM38510/ 30903BFA
M38510/07903BEA	Active	Production	CDIP (J) 16	25 TUBE	No	SNPB	N/A for Pkg Type	-55 to 125	JM38510/ 07903BEA

Orderable part number	Status (1)	Material type (2)	Package Pins	Package qty Carrier	RoHS (3)	Lead finish/ Ball material (4)	MSL rating/ Peak reflow (5)	Op temp (°C)	Part marking (6)
M38510/07903BFA	Active	Production	CFP (W) 16	25 TUBE	No	SNPB	N/A for Pkg Type	-55 to 125	JM38510/ 07903BFA
M38510/30903B2A	Active	Production	LCCC (FK) 20	55 TUBE	No	SNPB	N/A for Pkg Type	-55 to 125	JM38510/ 30903B2A
M38510/30903BEA	Active	Production	CDIP (J) 16	25 TUBE	No	SNPB	N/A for Pkg Type	-55 to 125	JM38510/ 30903BEA
M38510/30903BFA	Active	Production	CFP (W) 16	25 TUBE	No	SNPB	N/A for Pkg Type	-55 to 125	JM38510/ 30903BFA
SN54157J	Active	Production	CDIP (J) 16	25 TUBE	No	SNPB	N/A for Pkg Type	-55 to 125	SN54157J
SN54157J.A	Active	Production	CDIP (J) 16	25 TUBE	No	SNPB	N/A for Pkg Type	-55 to 125	SN54157J
SN54LS157J	Active	Production	CDIP (J) 16	25 TUBE	No	SNPB	N/A for Pkg Type	-55 to 125	SN54LS157J
SN54LS157J.A	Active	Production	CDIP (J) 16	25 TUBE	No	SNPB	N/A for Pkg Type	-55 to 125	SN54LS157J
SN54LS158J	Active	Production	CDIP (J) 16	25 TUBE	No	SNPB	N/A for Pkg Type	-55 to 125	SN54LS158J
SN54LS158J.A	Active	Production	CDIP (J) 16	25 TUBE	No	SNPB	N/A for Pkg Type	-55 to 125	SN54LS158J
SN54S157J	Active	Production	CDIP (J) 16	25 TUBE	No	SNPB	N/A for Pkg Type	-55 to 125	SN54S157J
SN54S157J.A	Active	Production	CDIP (J) 16	25 TUBE	No	SNPB	N/A for Pkg Type	-55 to 125	SN54S157J
SN74LS157D	Obsolete	Production	SOIC (D) 16	-	-	Call TI	Call TI	0 to 70	LS157
SN74LS157DR	Active	Production	SOIC (D) 16	2500 LARGE T&R	Yes	NIPDAU	Level-1-260C-UNLIM	0 to 70	LS157
SN74LS157DR.A	Active	Production	SOIC (D) 16	2500 LARGE T&R	Yes	NIPDAU	Level-1-260C-UNLIM	0 to 70	LS157
SN74LS157DRE4	Active	Production	SOIC (D) 16	2500 LARGE T&R	Yes	NIPDAU	Level-1-260C-UNLIM	0 to 70	LS157
SN74LS157N	Active	Production	PDIP (N) 16	25 TUBE	Yes	NIPDAU	N/A for Pkg Type	0 to 70	SN74LS157N
SN74LS157N.A	Active	Production	PDIP (N) 16	25 TUBE	Yes	NIPDAU	N/A for Pkg Type	0 to 70	SN74LS157N
SN74LS157NE4	Active	Production	PDIP (N) 16	25 TUBE	Yes	NIPDAU	N/A for Pkg Type	0 to 70	SN74LS157N
SN74LS157NSR	Active	Production	SOP (NS) 16	2000 LARGE T&R	Yes	NIPDAU	Level-1-260C-UNLIM	0 to 70	74LS157
SN74LS157NSR.A	Active	Production	SOP (NS) 16	2000 LARGE T&R	Yes	NIPDAU	Level-1-260C-UNLIM	0 to 70	74LS157
SN74LS158D	Obsolete	Production	SOIC (D) 16	-	-	Call TI	Call TI	0 to 70	LS158
SN74LS158DR	Active	Production	SOIC (D) 16	2500 LARGE T&R	Yes	NIPDAU	Level-1-260C-UNLIM	0 to 70	LS158
SN74LS158DR.A	Active	Production	SOIC (D) 16	2500 LARGE T&R	Yes	NIPDAU	Level-1-260C-UNLIM	0 to 70	LS158
SN74LS158N	Active	Production	PDIP (N) 16	25 TUBE	Yes	NIPDAU	N/A for Pkg Type	0 to 70	SN74LS158N
SN74LS158N.A	Active	Production	PDIP (N) 16	25 TUBE	Yes	NIPDAU	N/A for Pkg Type	0 to 70	SN74LS158N
SN74LS158NSR	Active	Production	SOP (NS) 16	2000 LARGE T&R	Yes	NIPDAU	Level-1-260C-UNLIM	0 to 70	74LS158
SN74LS158NSR.A	Active	Production	SOP (NS) 16	2000 LARGE T&R	Yes	NIPDAU	Level-1-260C-UNLIM	0 to 70	74LS158

Orderable part number	Status (1)	Material type (2)	Package Pins	Package qty Carrier	RoHS (3)	Lead finish/ Ball material (4)	MSL rating/ Peak reflow (5)	Op temp (°C)	Part marking (6)
SNJ54157J	Active	Production	CDIP (J) 16	25 TUBE	No	SNPB	N/A for Pkg Type	-55 to 125	SNJ54157J
SNJ54157J.A	Active	Production	CDIP (J) 16	25 TUBE	No	SNPB	N/A for Pkg Type	-55 to 125	SNJ54157J
SNJ54157W	Active	Production	CFP (W) 16	25 TUBE	No	SNPB	N/A for Pkg Type	-55 to 125	SNJ54157W
SNJ54157W.A	Active	Production	CFP (W) 16	25 TUBE	No	SNPB	N/A for Pkg Type	-55 to 125	SNJ54157W
SNJ54LS157FK	Active	Production	LCCC (FK) 20	55 TUBE	No	SNPB	N/A for Pkg Type	-55 to 125	76002012A SNJ54LS 157FK
SNJ54LS157FK.A	Active	Production	LCCC (FK) 20	55 TUBE	No	SNPB	N/A for Pkg Type	-55 to 125	76002012A SNJ54LS 157FK
SNJ54LS157J	Active	Production	CDIP (J) 16	25 TUBE	No	SNPB	N/A for Pkg Type	-55 to 125	7600201EA SNJ54LS157J
SNJ54LS157J.A	Active	Production	CDIP (J) 16	25 TUBE	No	SNPB	N/A for Pkg Type	-55 to 125	7600201EA SNJ54LS157J
SNJ54LS157W	Active	Production	CFP (W) 16	25 TUBE	No	SNPB	N/A for Pkg Type	-55 to 125	7600201FA SNJ54LS157W
SNJ54LS157W.A	Active	Production	CFP (W) 16	25 TUBE	No	SNPB	N/A for Pkg Type	-55 to 125	7600201FA SNJ54LS157W
SNJ54LS158FK	Active	Production	LCCC (FK) 20	55 TUBE	No	SNPB	N/A for Pkg Type	-55 to 125	76033012A SNJ54LS 158FK
SNJ54LS158FK.A	Active	Production	LCCC (FK) 20	55 TUBE	No	SNPB	N/A for Pkg Type	-55 to 125	76033012A SNJ54LS 158FK
SNJ54LS158J	Active	Production	CDIP (J) 16	25 TUBE	No	SNPB	N/A for Pkg Type	-55 to 125	7603301EA SNJ54LS158J
SNJ54LS158J.A	Active	Production	CDIP (J) 16	25 TUBE	No	SNPB	N/A for Pkg Type	-55 to 125	7603301EA SNJ54LS158J
SNJ54S157FK	Active	Production	LCCC (FK) 20	55 TUBE	No	SNPB	N/A for Pkg Type	-55 to 125	SNJ54S 157FK
SNJ54S157FK.A	Active	Production	LCCC (FK) 20	55 TUBE	No	SNPB	N/A for Pkg Type	-55 to 125	SNJ54S 157FK
SNJ54S157J	Active	Production	CDIP (J) 16	25 TUBE	No	SNPB	N/A for Pkg Type	-55 to 125	SNJ54S157J
SNJ54S157J.A	Active	Production	CDIP (J) 16	25 TUBE	No	SNPB	N/A for Pkg Type	-55 to 125	SNJ54S157J
SNJ54S157W	Active	Production	CFP (W) 16	25 TUBE	No	SNPB	N/A for Pkg Type	-55 to 125	SNJ54S157W

Orderable part number	Status (1)	Material type (2)	Package Pins	Package qty Carrier	RoHS (3)	Lead finish/ Ball material (4)	MSL rating/ Peak reflow (5)	Op temp (°C)	Part marking (6)
SNJ54S157W.A	Active	Production	CFP (W) 16	25 TUBE	No	SNPB	N/A for Pkg Type	-55 to 125	SNJ54S157W

(1) **Status:** For more details on status, see our [product life cycle](#).

(2) **Material type:** When designated, preproduction parts are prototypes/experimental devices, and are not yet approved or released for full production. Testing and final process, including without limitation quality assurance, reliability performance testing, and/or process qualification, may not yet be complete, and this item is subject to further changes or possible discontinuation. If available for ordering, purchases will be subject to an additional waiver at checkout, and are intended for early internal evaluation purposes only. These items are sold without warranties of any kind.

(3) **RoHS values:** Yes, No, RoHS Exempt. See the [TI RoHS Statement](#) for additional information and value definition.

(4) **Lead finish/Ball material:** Parts may have multiple material finish options. Finish options are separated by a vertical ruled line. Lead finish/Ball material values may wrap to two lines if the finish value exceeds the maximum column width.

(5) **MSL rating/Peak reflow:** The moisture sensitivity level ratings and peak solder (reflow) temperatures. In the event that a part has multiple moisture sensitivity ratings, only the lowest level per JEDEC standards is shown. Refer to the shipping label for the actual reflow temperature that will be used to mount the part to the printed circuit board.

(6) **Part marking:** There may be an additional marking, which relates to the logo, the lot trace code information, or the environmental category of the part.

Multiple part markings will be inside parentheses. Only one part marking contained in parentheses and separated by a "~" will appear on a part. If a line is indented then it is a continuation of the previous line and the two combined represent the entire part marking for that device.

Important Information and Disclaimer:The information provided on this page represents TI's knowledge and belief as of the date that it is provided. TI bases its knowledge and belief on information provided by third parties, and makes no representation or warranty as to the accuracy of such information. Efforts are underway to better integrate information from third parties. TI has taken and continues to take reasonable steps to provide representative and accurate information but may not have conducted destructive testing or chemical analysis on incoming materials and chemicals. TI and TI suppliers consider certain information to be proprietary, and thus CAS numbers and other limited information may not be available for release.

In no event shall TI's liability arising out of such information exceed the total purchase price of the TI part(s) at issue in this document sold by TI to Customer on an annual basis.

OTHER QUALIFIED VERSIONS OF SN54LS157, SN54LS158, SN74LS157, SN74LS158 :

- Catalog : [SN74LS157](#), [SN74LS158](#)
- Military : [SN54LS157](#), [SN54LS158](#)

NOTE: Qualified Version Definitions:

- Catalog - TI's standard catalog product
- Military - QML certified for Military and Defense Applications

TAPE AND REEL INFORMATION

QUADRANT ASSIGNMENTS FOR PIN 1 ORIENTATION IN TAPE

*All dimensions are nominal

Device	Package Type	Package Drawing	Pins	SPQ	Reel Diameter (mm)	Reel Width W1 (mm)	A0 (mm)	B0 (mm)	K0 (mm)	P1 (mm)	W (mm)	Pin1 Quadrant
SN74LS157DR	SOIC	D	16	2500	330.0	16.4	6.5	10.3	2.1	8.0	16.0	Q1
SN74LS157NSR	SOP	NS	16	2000	330.0	16.4	8.45	10.55	2.5	12.0	16.2	Q1
SN74LS157NSR	SOP	NS	16	2000	330.0	16.4	8.1	10.4	2.5	12.0	16.0	Q1
SN74LS158DR	SOIC	D	16	2500	330.0	16.4	6.5	10.3	2.1	8.0	16.0	Q1
SN74LS158NSR	SOP	NS	16	2000	330.0	16.4	8.1	10.4	2.5	12.0	16.0	Q1

TAPE AND REEL BOX DIMENSIONS

*All dimensions are nominal

Device	Package Type	Package Drawing	Pins	SPQ	Length (mm)	Width (mm)	Height (mm)
SN74LS157DR	SOIC	D	16	2500	340.5	336.1	32.0
SN74LS157NSR	SOP	NS	16	2000	353.0	353.0	32.0
SN74LS157NSR	SOP	NS	16	2000	353.0	353.0	32.0
SN74LS158DR	SOIC	D	16	2500	353.0	353.0	32.0
SN74LS158NSR	SOP	NS	16	2000	353.0	353.0	32.0

TUBE

*All dimensions are nominal

Device	Package Name	Package Type	Pins	SPQ	L (mm)	W (mm)	T (µm)	B (mm)
76002012A	FK	LCCC	20	55	506.98	12.06	2030	NA
7600201FA	W	CFP	16	25	506.98	26.16	6220	NA
76033012A	FK	LCCC	20	55	506.98	12.06	2030	NA
JM38510/07903BFA	W	CFP	16	25	506.98	26.16	6220	NA
JM38510/07903BFA.A	W	CFP	16	25	506.98	26.16	6220	NA
JM38510/30903B2A	FK	LCCC	20	55	506.98	12.06	2030	NA
JM38510/30903B2A.A	FK	LCCC	20	55	506.98	12.06	2030	NA
JM38510/30903BFA	W	CFP	16	25	506.98	26.16	6220	NA
JM38510/30903BFA.A	W	CFP	16	25	506.98	26.16	6220	NA
M38510/07903BFA	W	CFP	16	25	506.98	26.16	6220	NA
M38510/30903B2A	FK	LCCC	20	55	506.98	12.06	2030	NA
M38510/30903BFA	W	CFP	16	25	506.98	26.16	6220	NA
SN74LS157N	N	PDIP	16	25	506	13.97	11230	4.32
SN74LS157N	N	PDIP	16	25	506	13.97	11230	4.32
SN74LS157N.A	N	PDIP	16	25	506	13.97	11230	4.32
SN74LS157N.A	N	PDIP	16	25	506	13.97	11230	4.32
SN74LS157NE4	N	PDIP	16	25	506	13.97	11230	4.32
SN74LS157NE4	N	PDIP	16	25	506	13.97	11230	4.32
SN74LS158N	N	PDIP	16	25	506	13.97	11230	4.32
SN74LS158N	N	PDIP	16	25	506	13.97	11230	4.32
SN74LS158N.A	N	PDIP	16	25	506	13.97	11230	4.32
SN74LS158N.A	N	PDIP	16	25	506	13.97	11230	4.32
SNJ54157W	W	CFP	16	25	506.98	26.16	6220	NA
SNJ54157W.A	W	CFP	16	25	506.98	26.16	6220	NA
SNJ54LS157FK	FK	LCCC	20	55	506.98	12.06	2030	NA
SNJ54LS157FK.A	FK	LCCC	20	55	506.98	12.06	2030	NA
SNJ54LS157W	W	CFP	16	25	506.98	26.16	6220	NA
SNJ54LS157W.A	W	CFP	16	25	506.98	26.16	6220	NA
SNJ54LS158FK	FK	LCCC	20	55	506.98	12.06	2030	NA

Device	Package Name	Package Type	Pins	SPQ	L (mm)	W (mm)	T (μm)	B (mm)
SNJ54LS158FK.A	FK	LCCC	20	55	506.98	12.06	2030	NA
SNJ54S157FK	FK	LCCC	20	55	506.98	12.06	2030	NA
SNJ54S157FK.A	FK	LCCC	20	55	506.98	12.06	2030	NA

W (R-GDFP-F16)

CERAMIC DUAL FLATPACK



- NOTES:
- A. All linear dimensions are in inches (millimeters).
 - B. This drawing is subject to change without notice.
 - C. This package can be hermetically sealed with a ceramic lid using glass frit.
 - D. Index point is provided on cap for terminal identification only.
 - E. Falls within MIL STD 1835 GDFP2-F16

GENERIC PACKAGE VIEW

FK 20

LCCC - 2.03 mm max height

8.89 x 8.89, 1.27 mm pitch

LEADLESS CERAMIC CHIP CARRIER

This image is a representation of the package family, actual package may vary.
Refer to the product data sheet for package details.



4229370VA\

J (R-GDIP-T**)

14 LEADS SHOWN

CERAMIC DUAL IN-LINE PACKAGE



DIM \ PINS **	14	16	18	20
A	0.300 (7,62) BSC	0.300 (7,62) BSC	0.300 (7,62) BSC	0.300 (7,62) BSC
B MAX	0.785 (19,94)	.840 (21,34)	0.960 (24,38)	1.060 (26,92)
B MIN	—	—	—	—
C MAX	0.300 (7,62)	0.300 (7,62)	0.310 (7,87)	0.300 (7,62)
C MIN	0.245 (6,22)	0.245 (6,22)	0.220 (5,59)	0.245 (6,22)



4040083/F 03/03

- NOTES:
- All linear dimensions are in inches (millimeters).
 - This drawing is subject to change without notice.
 - This package is hermetically sealed with a ceramic lid using glass frit.
 - Index point is provided on cap for terminal identification only on press ceramic glass frit seal only.
 - Falls within MIL STD 1835 GDIP1-T14, GDIP1-T16, GDIP1-T18 and GDIP1-T20.

N (R-PDIP-T**)

PLASTIC DUAL-IN-LINE PACKAGE

16 PINS SHOWN



4040049/E 12/2002

- NOTES:
- A. All linear dimensions are in inches (millimeters).
 - B. This drawing is subject to change without notice.
 - (C) Falls within JEDEC MS-001, except 18 and 20 pin minimum body length (Dim A).
 - (D) The 20 pin end lead shoulder width is a vendor option, either half or full width.



PACKAGE OUTLINE

NS0016A

SOP - 2.00 mm max height

SOP



4220735/A 12/2021

NOTES:

1. All linear dimensions are in millimeters. Dimensions in parenthesis are for reference only. Dimensioning and tolerancing per ASME Y14.5M.
2. This drawing is subject to change without notice.
3. This dimension does not include mold flash, protrusions, or gate burrs. Mold flash, protrusions, or gate burrs shall not exceed 0.15 mm, per side.
4. This dimension does not include interlead flash. Interlead flash shall not exceed 0.25 mm, per side.

EXAMPLE BOARD LAYOUT

NS0016A

SOP - 2.00 mm max height

SOP



4220735/A 12/2021

NOTES: (continued)

5. Publication IPC-7351 may have alternate designs.

6. Solder mask tolerances between and around signal pads can vary based on board fabrication site.

EXAMPLE STENCIL DESIGN

NS0016A

SOP - 2.00 mm max height

SOP



SOLDER PASTE EXAMPLE
BASED ON 0.125 mm THICK STENCIL
SCALE:7X

4220735/A 12/2021



NOTES: (continued)

7. Laser cutting apertures with trapezoidal walls and rounded corners may offer better paste release. IPC-7525 may have alternate design recommendations.
8. Board assembly site may have different recommendations for stencil design.

D (R-PDSO-G16)

PLASTIC SMALL OUTLINE



- NOTES:
- A. All linear dimensions are in inches (millimeters).
 - B. This drawing is subject to change without notice.
 -  C. Body length does not include mold flash, protrusions, or gate burrs. Mold flash, protrusions, or gate burrs shall not exceed 0.006 (0,15) each side.
 -  D. Body width does not include interlead flash. Interlead flash shall not exceed 0.017 (0,43) each side.
 - E. Reference JEDEC MS-012 variation AC.

IMPORTANT NOTICE AND DISCLAIMER

TI PROVIDES TECHNICAL AND RELIABILITY DATA (INCLUDING DATASHEETS), DESIGN RESOURCES (INCLUDING REFERENCE DESIGNS), APPLICATION OR OTHER DESIGN ADVICE, WEB TOOLS, SAFETY INFORMATION, AND OTHER RESOURCES "AS IS" AND WITH ALL FAULTS, AND DISCLAIMS ALL WARRANTIES, EXPRESS AND IMPLIED, INCLUDING WITHOUT LIMITATION ANY IMPLIED WARRANTIES OF MERCHANTABILITY, FITNESS FOR A PARTICULAR PURPOSE OR NON-INFRINGEMENT OF THIRD PARTY INTELLECTUAL PROPERTY RIGHTS.

These resources are intended for skilled developers designing with TI products. You are solely responsible for (1) selecting the appropriate TI products for your application, (2) designing, validating and testing your application, and (3) ensuring your application meets applicable standards, and any other safety, security, regulatory or other requirements.

These resources are subject to change without notice. TI grants you permission to use these resources only for development of an application that uses the TI products described in the resource. Other reproduction and display of these resources is prohibited. No license is granted to any other TI intellectual property right or to any third party intellectual property right. TI disclaims responsibility for, and you fully indemnify TI and its representatives against any claims, damages, costs, losses, and liabilities arising out of your use of these resources.

TI's products are provided subject to [TI's Terms of Sale](#), [TI's General Quality Guidelines](#), or other applicable terms available either on ti.com or provided in conjunction with such TI products. TI's provision of these resources does not expand or otherwise alter TI's applicable warranties or warranty disclaimers for TI products. Unless TI explicitly designates a product as custom or customer-specified, TI products are standard, catalog, general purpose devices.

TI objects to and rejects any additional or different terms you may propose.

Copyright © 2026, Texas Instruments Incorporated

Last updated 10/2025