

TLV916x 16V, 11MHz, Rail-to-Rail Input/Output, Low Offset Voltage, Low Noise Op Amp

1 Features

- Low offset voltage: $\pm 210\mu\text{V}$
- Low offset voltage drift: $\pm 0.25\mu\text{V}/^\circ\text{C}$
- Low noise: $6.8\text{nV}/\sqrt{\text{Hz}}$ at 1kHz, $4.2\text{nV}/\sqrt{\text{Hz}}$ broadband
- High common-mode rejection: 110dB
- Low bias current: $\pm 10\text{pA}$
- Rail-to-rail input and output
- MUX-friendly/comparator inputs
 - Amplifier operates with differential inputs up to supply rails
 - Amplifier can be used in open-loop or as comparator
- Wide bandwidth: 11MHz GBW, unity-gain stable
- High slew rate: $33\text{V}/\mu\text{s}$
- Low quiescent current: 2.4mA per amplifier
- Wide supply: $\pm 1.35\text{V}$ to $\pm 8\text{V}$, 2.7V to 16V
- Robust EMIRR performance

2 Applications

- [Professional microphones and wireless systems](#)
- [Multiplexed data-acquisition systems](#)
- [Test and measurement equipment](#)
- [Factory automation and control](#)
- [High-side and low-side current sensing](#)

3 Description

The TLV916x family (TLV9161, TLV9162, and TLV9164) is a family of 16V, general-purpose operational amplifiers. These devices offer exceptional DC precision and AC performance, including rail-to-rail input/output, low offset ($\pm 210\mu\text{V}$, typical), low-offset drift ($\pm 0.25\mu\text{V}/^\circ\text{C}$, typ), and low noise ($6.8\text{nV}/\sqrt{\text{Hz}}$ at 1kHz, $4.2\text{nV}/\sqrt{\text{Hz}}$ at 10kHz).

Features such as differential and common-mode input voltage ranges to the supply rails, high short-circuit current ($\pm 73\text{mA}$), and high slew rate ($33\text{V}/\mu\text{s}$) make the TLV916x a flexible, robust, and high-performance op amp for industrial applications.

The TLV916x family of op amps is available in small-size packages (such as X2QFN and WSON), as well as standard packages (such as SOT-23, SOIC, and TSSOP), and is specified from -40°C to 125°C .

Device Information

PART NUMBER ⁽¹⁾	CHANNEL COUNT	PACKAGE	PACKAGE SIZE ⁽²⁾
TLV9161	Single	DCK (SC70, 5)	2.00mm × 2.10mm
		DBV (SOT-23, 5)	2.90mm × 2.80mm
TLV9161S	Single, Shutdown	DBV (SOT-23, 6)	2.90mm × 2.80mm
TLV9162	Dual	D (SOIC, 8)	4.90mm × 6.00mm
		DDF (SOT-23, 8)	2.90mm × 2.80mm
		PW (TSSOP, 8)	3.00mm × 6.40mm
		DGK (VSSOP, 8)	3.00mm × 4.90mm
		DSG (WSON, 8)	2.00mm × 2.00mm
TLV9162S	Dual, Shutdown	RUG (X2QFN, 10)	1.50mm × 2.00mm
TLV9164	Quad	D (SOIC, 14)	8.65mm × 6.00mm
		PW (TSSOP, 14)	5.00mm × 6.40mm

(1) For more information, see [Section 10](#)

(2) The package size (length × width) is a nominal value and includes pins, where applicable.

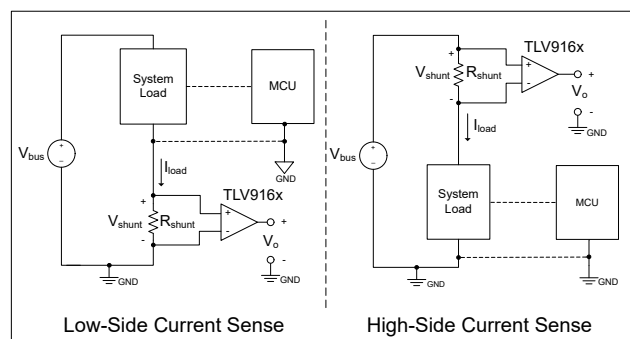

TLV916x in Current-Sensing Applications



Table of Contents

1 Features	1	6.4 Device Functional Modes.....	27
2 Applications	1	7 Application and Implementation	28
3 Description	1	7.1 Application Information.....	28
4 Pin Configuration and Functions	3	7.2 Typical Applications.....	28
5 Specifications	7	7.3 Power Supply Recommendations.....	30
5.1 Absolute Maximum Ratings.....	7	7.4 Layout.....	30
5.2 ESD Ratings.....	7	8 Device and Documentation Support	33
5.3 Recommended Operating Conditions.....	7	8.1 Device Support.....	33
5.4 Thermal Information for Single Channel.....	8	8.2 Documentation Support.....	33
5.5 Thermal Information for Dual Channel.....	8	8.3 Receiving Notification of Documentation Updates....	33
5.6 Thermal Information for Quad Channel.....	8	8.4 Support Resources.....	33
5.7 Electrical Characteristics.....	9	8.5 Trademarks.....	33
5.8 Typical Characteristics.....	12	8.6 Electrostatic Discharge Caution.....	33
6 Detailed Description	19	8.7 Glossary.....	34
6.1 Overview.....	19	9 Revision History	34
6.2 Functional Block Diagram.....	19	10 Mechanical, Packaging, and Orderable Information	35
6.3 Feature Description.....	20		

4 Pin Configuration and Functions

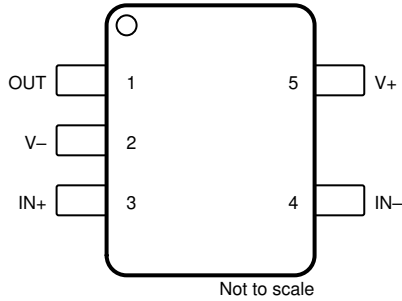

**Figure 4-1. TLV9161 DBV Package
5-Pin SOT-23
(Top View)**

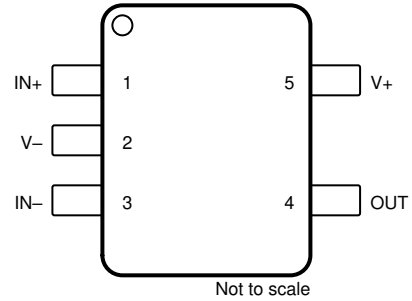

**Figure 4-2. TLV9161 DCK Package
5-Pin SC70
(Top View)**

Table 4-1. Pin Functions: TLV9161

NAME	PIN		I/O	DESCRIPTION
	SOT-23	SC70		
IN+	3	1	I	Noninverting input
IN-	4	3	I	Inverting input
OUT	1	4	O	Output
V+	5	5	—	Positive (highest) power supply
V-	2	2	—	Negative (lowest) power supply

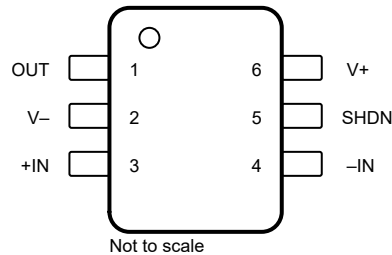

**Figure 4-3. TLV9161S DBV Package
6-Pin SOT-23
(Top View)**

Table 4-2. Pin Functions: TLV9161S

NAME	PIN		I/O	DESCRIPTION
	NO.			
+IN	3		I	Noninverting input
-IN	4		I	Inverting input
OUT	1		O	Output
SHDN	5		I	Shutdown: low = amplifier enabled, high = amplifier disabled
V+	6		—	Positive (highest) power supply
V-	2		—	Negative (lowest) power supply



Not to scale

**Figure 4-4. TLV9162 D, DDF, PW, and DGK Package
8-Pin SOIC, SOT-23, TSSOP, and VSSOP
(Top View)**



Not to scale

A. Connect thermal pad to V-. See [Section 6.3.10](#) for more information.

**Figure 4-5. TLV9162 DSG Package^(A)
8-Pin WSON With Exposed Thermal Pad
(Top View)**

Table 4-3. Pin Functions: TLV9162

PIN		I/O	DESCRIPTION
NAME	NO.		
IN1+	3	I	Noninverting input, channel 1
IN1-	2	I	Inverting input, channel 1
IN2+	5	I	Noninverting input, channel 2
IN2-	6	I	Inverting input, channel 2
OUT1	1	O	Output, channel 1
OUT2	7	O	Output, channel 2
V+	8	—	Positive (highest) power supply
V-	4	—	Negative (lowest) power supply



**Figure 4-6. TLV9162S RUG Package
10-Pin X2QFN
(Top View)**

Table 4-4. Pin Functions: TLV9162S

PIN		I/O	DESCRIPTION
NAME	NO.		
IN1+	10	I	Noninverting input, channel 1
IN1-	9	I	Inverting input, channel 1
IN2+	4	I	Noninverting input, channel 2
IN2-	5	I	Inverting input, channel 2
OUT1	8	O	Output, channel 1
OUT2	6	O	Output, channel 2
SHDN1	2	I	Shutdown, channel 1: low = amplifier enabled, high = amplifier disabled. See Section 6.3.11 for more information.
SHDN2	3	I	Shutdown, channel 2: low = amplifier enabled, high = amplifier disabled. See Section 6.3.11 for more information.
V+	7	—	Positive (highest) power supply
V-	1	—	Negative (lowest) power supply



Not to scale

**Figure 4-7. TLV9164 D and PW Package
14-Pin SOIC and TSSOP
(Top View)**

Table 4-5. Pin Functions: TLV9164

PIN		I/O	DESCRIPTION
NAME	NO.		
IN1+	3	I	Noninverting input, channel 1
IN1–	2	I	Inverting input, channel 1
IN2+	5	I	Noninverting input, channel 2
IN2–	6	I	Inverting input, channel 2
IN3+	10	I	Noninverting input, channel 3
IN3–	9	I	Inverting input, channel 3
IN4+	12	I	Noninverting input, channel 4
IN4–	13	I	Inverting input, channel 4
OUT1	1	O	Output, channel 1
OUT2	7	O	Output, channel 2
OUT3	8	O	Output, channel 3
OUT4	14	O	Output, channel 4
V+	4	—	Positive (highest) power supply
V–	11	—	Negative (lowest) power supply

5 Specifications

5.1 Absolute Maximum Ratings

over operating ambient temperature range (unless otherwise noted)⁽¹⁾

		MIN	MAX	UNIT
Supply voltage, $V_S = (V+) - (V-)$		0	20	V
Signal input pins	Common-mode voltage ⁽³⁾	$(V-) - 0.5$	$(V+) + 0.5$	V
	Differential voltage ⁽³⁾		$V_S + 0.2$	V
	Current ⁽³⁾	-10	10	mA
Shutdown pin voltage		$V-$	$V+$	
Output short-circuit ⁽²⁾		Continuous		
Operating ambient temperature, T_A		-55	150	°C
Junction temperature, T_J			150	°C
Storage temperature, T_{stg}		-65	150	°C

- Operating the device beyond the ratings listed under *Absolute Maximum Ratings* will cause permanent damage to the device. These are stress ratings only, based on process and design limitations, and this device has not been designed to function outside the conditions indicated under *Recommended Operating Conditions*. Exposure to any condition outside *Recommended Operating Conditions* for extended periods, including absolute-maximum-rated conditions, may affect device reliability and performance.
- Short-circuit to ground, one amplifier per package. Extended short-circuit current, especially with higher supply voltage, can cause excessive heating and eventual destruction.
- Input pins are diode-clamped to the power-supply rails. Input signals that may swing more than 0.5 V beyond the supply rails must be current limited to 10 mA or less.

5.2 ESD Ratings

			VALUE	UNIT
$V_{(ESD)}$	Electrostatic discharge	Human-body model (HBM), per ANSI/ESDA/JEDEC JS-001 ⁽¹⁾	±2500	V
		Charged-device model (CDM), per ANSI/ESDA/JEDEC JS-002 ⁽²⁾	±1500	

- JEDEC document JEP155 states that 500-V HBM allows safe manufacturing with a standard ESD control process.
- JEDEC document JEP157 states that 250-V CDM allows safe manufacturing with a standard ESD control process.

5.3 Recommended Operating Conditions

over operating ambient temperature range (unless otherwise noted)

		MIN	MAX	UNIT
V_S	Supply voltage, $(V+) - (V-)$	2.7	16	V
V_I	Common mode voltage range	$V-$	$V+$	V
V_{IH}	High level input voltage at shutdown pin (amplifier disabled)	$(V-) + 1.1$	$V+$	V
V_{IL}	Low level input voltage at shutdown pin (amplifier enabled)	$V-$	$(V-) + 0.2$	V
T_A	Specified temperature	-40	125	°C

5.4 Thermal Information for Single Channel

THERMAL METRIC ⁽¹⁾		TLV9161, TLV9161S			Unit
		DBV (SOT-23)		DCK (SC70)	
		5 PINS	6 PINS	5 PINS	
R _{θJA}	Junction-to-ambient thermal resistance	185.4	166.9	198.1	°C/W
R _{θJC(top)}	Junction-to-case (top) thermal resistance	83.9	83.9	94.1	°C/W
R _{θJB}	Junction-to-board thermal resistance	52.5	47.1	45.3	°C/W
ψ _{JT}	Junction-to-top characterization parameter	25.4	25.9	16.9	°C/W
ψ _{JB}	Junction-to-board characterization parameter	52.1	47.0	45.0	°C/W
R _{θJC(bot)}	Junction-to-case (bottom) thermal resistance	N/A	N/A	N/A	°C/W

(1) For more information about traditional and new thermal metrics, see the [Semiconductor and IC Package Thermal Metrics](#) application note.

5.5 Thermal Information for Dual Channel

THERMAL METRIC ⁽¹⁾		TLV9162, TLV9162S						Unit
		D (SOIC)	DDF (SOT-23)	DGK (VSSOP)	DSG (WSON)	PW (TSSOP)	RUG (X2QFN)	
		8 PINS	8 PINS	8 PINS	8 PINS	8 PINS	10 PINS	
R _{θJA}	Junction-to-ambient thermal resistance	131.0	149.6	174.2	74.8	183.4	131.7	°C/W
R _{θJC(top)}	Junction-to-case (top) thermal resistance	73.0	85.3	65.9	93.6	72.4	52.9	°C/W
R _{θJB}	Junction-to-board thermal resistance	74.5	68.6	95.9	42.1	114.0	62.0	°C/W
ψ _{JT}	Junction-to-top characterization parameter	25.0	7.9	11.0	3.8	12.1	1.1	°C/W
ψ _{JB}	Junction-to-board characterization parameter	73.8	68.4	94.4	41.9	112.3	61.8	°C/W
R _{θJC(bot)}	Junction-to-case (bottom) thermal resistance	N/A	N/A	N/A	17.0	N/A	N/A	°C/W

(1) For more information about traditional and new thermal metrics, see the [Semiconductor and IC Package Thermal Metrics](#) application note.

5.6 Thermal Information for Quad Channel

THERMAL METRIC ⁽¹⁾		TLV9164		UNIT
		D (SOIC)	PW (TSSOP)	
		14 PINS	14 PINS	
R _{θJA}	Junction-to-ambient thermal resistance	99.0	118.8	°C/W
R _{θJC(top)}	Junction-to-case (top) thermal resistance	55.1	47.0	°C/W
R _{θJB}	Junction-to-board thermal resistance	54.8	61.9	°C/W
ψ _{JT}	Junction-to-top characterization parameter	16.7	5.5	°C/W
ψ _{JB}	Junction-to-board characterization parameter	54.4	61.3	°C/W
R _{θJC(bot)}	Junction-to-case (bottom) thermal resistance	N/A	N/A	°C/W

(1) For more information about traditional and new thermal metrics, see the [Semiconductor and IC Package Thermal Metrics](#) application note.

5.7 Electrical Characteristics

For $V_S = (V+) - (V-) = 2.7\text{ V to }16\text{ V}$ ($\pm 1.35\text{ V to } \pm 8\text{ V}$) at $T_A = 25^\circ\text{C}$, $R_L = 10\text{ k}\Omega$ connected to $V_S / 2$, $V_{CM} = V_S / 2$, and $V_{OUT} = V_S / 2$, unless otherwise noted.

PARAMETER		TEST CONDITIONS		MIN	TYP	MAX	UNIT
OFFSET VOLTAGE							
V_{OS}	Input offset voltage	$V_{CM} = V_-$	$T_A = -40^\circ\text{C to }125^\circ\text{C}$		± 0.21	± 1	mV
dV_{OS}/dT	Input offset voltage drift	$V_{CM} = V_-$	$T_A = -40^\circ\text{C to }125^\circ\text{C}$		± 0.25		$\mu\text{V}/^\circ\text{C}$
PSRR	Input offset voltage versus power supply	TLV9161, TLV9162, $V_{CM} = V_-$, $V_S = 5\text{ V to }16\text{ V}$	$T_A = -40^\circ\text{C to }125^\circ\text{C}$		± 0.45	± 2	$\mu\text{V}/\text{V}$
			$T_A = -40^\circ\text{C to }125^\circ\text{C}$		± 0.45	± 3	
		TLV9162SIRUGR, $V_{CM} = V_-$, $V_S = 5\text{ V to }16\text{ V}^{(1)}$	$T_A = -40^\circ\text{C to }125^\circ\text{C}$		± 0.45	± 2.8	
			$T_A = -40^\circ\text{C to }125^\circ\text{C}$		± 0.45	± 3.1	
		TLV9164, $V_{CM} = V_-$, $V_S = 5\text{ V to }16\text{ V}$	$T_A = -40^\circ\text{C to }125^\circ\text{C}$		± 0.45	± 2.2	
TLV9161, TLV9162, TLV9164, $V_{CM} = V_-$, $V_S = 2.7\text{ V to }16\text{ V}^{(1)}$	$T_A = -40^\circ\text{C to }125^\circ\text{C}$			± 2	± 12		
	DC channel separation				0.4		$\mu\text{V}/\text{V}$
INPUT BIAS CURRENT							
I_B	Input bias current				± 10		pA
I_{OS}	Input offset current				± 10		pA
NOISE							
E_N	Input voltage noise	$f = 0.1\text{ Hz to }10\text{ Hz}$			2.7		μV_{PP}
					0.49		μV_{RMS}
e_N	Input voltage noise density	$f = 1\text{ kHz}$			6.8		$\text{nV}/\sqrt{\text{Hz}}$
		$f = 10\text{ kHz}$			4.2		
i_N	Input current noise density	$f = 1\text{ kHz}$			55		$\text{fA}/\sqrt{\text{Hz}}$
INPUT VOLTAGE RANGE							
V_{CM}	Common-mode voltage range			(V-)		(V+)	V
CMRR	Common-mode rejection ratio	$V_S = 16\text{ V}$, $V_- < V_{CM} < (V+) - 2\text{ V}$ (PMOS pair)	$T_A = -40^\circ\text{C to }125^\circ\text{C}$		85	110	dB
		$V_S = 5\text{ V}$, $V_- < V_{CM} < (V+) - 2\text{ V}$ (PMOS pair) ⁽¹⁾			75	98	
		$V_S = 2.7\text{ V}$, $V_- < V_{CM} < (V+) - 2\text{ V}$ (PMOS pair)				90	
		$V_S = 2.7 - 16\text{ V}$, $(V+) - 1\text{ V} < V_{CM} < V_+$ (NMOS pair)				78	
		$(V+) - 2\text{ V} < V_{CM} < (V+) - 1\text{ V}$				See Figure 5-6	
INPUT IMPEDANCE							
Z_{ID}	Differential				100 9		M Ω pF
Z_{ICM}	Common-mode				6 1		T Ω pF
OPEN-LOOP GAIN							
A_{OL}	Open-loop voltage gain	$V_S = 16\text{ V}$, $V_{CM} = V_S / 2$, $(V_-) + 0.1\text{ V} < V_O < (V+) - 0.1\text{ V}$	$T_A = -40^\circ\text{C to }125^\circ\text{C}$		120	136	dB
			$T_A = -40^\circ\text{C to }125^\circ\text{C}$			136	
		$V_S = 5\text{ V}$, $V_{CM} = V_S / 2$, $(V_-) + 0.1\text{ V} < V_O < (V+) - 0.1\text{ V}^{(1)}$	$T_A = -40^\circ\text{C to }125^\circ\text{C}$		104	125	
			$T_A = -40^\circ\text{C to }125^\circ\text{C}$			125	
$V_S = 2.7\text{ V}$, $V_{CM} = V_S / 2$, $(V_-) + 0.1\text{ V} < V_O < (V+) - 0.1\text{ V}^{(1)}$	$T_A = -40^\circ\text{C to }125^\circ\text{C}$		90	105			
	$T_A = -40^\circ\text{C to }125^\circ\text{C}$			105			
FREQUENCY RESPONSE							
GBW	Gain-bandwidth product				11		MHz
SR	Slew rate	$V_S = 16\text{ V}$, $G = +1$, $V_{STEP} = 10\text{ V}$, $C_L = 20\text{ pF}^{(3)}$			33		V/ μs

5.7 Electrical Characteristics (continued)

For $V_S = (V+) - (V-) = 2.7\text{ V to }16\text{ V}$ ($\pm 1.35\text{ V to } \pm 8\text{ V}$) at $T_A = 25^\circ\text{C}$, $R_L = 10\text{ k}\Omega$ connected to $V_S / 2$, $V_{CM} = V_S / 2$, and $V_{OUT} = V_S / 2$, unless otherwise noted.

PARAMETER		TEST CONDITIONS	MIN	TYP	MAX	UNIT
t _s	Settling time	To 0.1%, V _S = 16 V, V _{STEP} = 10 V, G = +1, C _L = 20 pF		0.70		μs
		To 0.1%, V _S = 16 V, V _{STEP} = 2 V, G = +1, C _L = 20 pF		0.22		
		To 0.01%, V _S = 16 V, V _{STEP} = 10 V, G = +1, C _L = 20 pF		0.89		
		To 0.01%, V _S = 16 V, V _{STEP} = 2 V, G = +1, C _L = 20 pF		0.42		
	Phase margin	G = +1, R _L = 10 kΩ, C _L = 20 pF		64		°
	Overload recovery time	V _{IN} × gain > V _S		120		ns
THD+N	Total harmonic distortion + noise	V _S = 16 V, V _O = 3 V _{RMS} , G = 1, f = 1 kHz		0.00005%		
				126		dB
		V _S = 10 V, V _O = 3 V _{RMS} , G = 1, f = 1 kHz, R _L = 128 Ω		0.0032%		
				90		dB
V _S = 10 V, V _O = 0.4 V _{RMS} , G = 1, f = 1 kHz, R _L = 32 Ω		0.00032%				
		110		dB		

5.7 Electrical Characteristics (continued)

For $V_S = (V+) - (V-) = 2.7\text{ V to }16\text{ V}$ ($\pm 1.35\text{ V to } \pm 8\text{ V}$) at $T_A = 25^\circ\text{C}$, $R_L = 10\text{ k}\Omega$ connected to $V_S / 2$, $V_{CM} = V_S / 2$, and $V_{OUT} = V_S / 2$, unless otherwise noted.

PARAMETER	TEST CONDITIONS		MIN	TYP	MAX	UNIT
OUTPUT						
Voltage output swing from rail	Positive and negative rail headroom	$V_S = 16\text{ V}$, $R_L = \text{no load}$		6		mV
		$V_S = 16\text{ V}$, $R_L = 10\text{ k}\Omega$		25	60	
		$V_S = 16\text{ V}$, $R_L = 2\text{ k}\Omega$		85	300	
		$V_S = 2.7\text{ V}$, $R_L = \text{no load}$		0.5		
		$V_S = 2.7\text{ V}$, $R_L = 10\text{ k}\Omega$		5	20	
		$V_S = 2.7\text{ V}$, $R_L = 2\text{ k}\Omega$		20	50	
I_{SC}	Short-circuit current			± 73		mA
C_{LOAD}	Capacitive load drive			See Figure 5-33		pF
Z_O	Open-loop output impedance	$I_O = 0\text{ A}$		See Figure 5-30		Ω
POWER SUPPLY						
I_Q	Quiescent current per amplifier	TLV9162, TLV9164, $I_O = 0\text{ A}$		2.4	2.8	mA
			$T_A = -40^\circ\text{C to }125^\circ\text{C}$		2.84	
		TLV9161, $I_O = 0\text{ A}$		2.48	2.92	
			$T_A = -40^\circ\text{C to }125^\circ\text{C}$		2.98	
SHUTDOWN						
I_{QSD}	Quiescent current per amplifier	$V_S = 2.7\text{ V to }16\text{ V}$, all amplifiers disabled, $SHDN = V- + 2\text{ V}$		36	45	μA
Z_{SHDN}	Output impedance during shutdown	$V_S = 2.7\text{ V to }16\text{ V}$, amplifier disabled		$10 \parallel 2$		$\text{G}\Omega \parallel \text{pF}$
V_{IH}	Logic high threshold voltage (amplifier disabled)	For valid input high, the SHDN pin voltage should be greater than the maximum threshold but less than or equal to $V+$			$(V-) + 1.1\text{ V}$	V
V_{IL}	Logic low threshold voltage (amplifier enabled)	For valid input low, the SHDN pin voltage should be less than the minimum threshold but greater than or equal to $V-$	$(V-) + 0.2\text{ V}$			V
t_{ON}	Amplifier enable time (from shutdown) ⁽²⁾	$V_S = \pm 8\text{ V}$, $G = +1$, $V_{CM} = V_S/2$, $R_L = 10\text{ k}\Omega$ connected to $V-$		5		μs
t_{OFF}	Amplifier disable time ⁽²⁾	$V_S = \pm 8\text{ V}$, $G = +1$, $V_{CM} = V_S/2$, $R_L = 10\text{ k}\Omega$ connected to $V-$		3		μs
	SHDN pin input bias current (per pin)	$V_S = 2.7\text{ V to }16\text{ V}$, $V+ \geq SHDN \geq (V-) + 0.9\text{ V}$		500		nA
		$V_S = 2.7\text{ V to }16\text{ V}$, $(V-) \leq SHDN \leq (V-) + 0.7\text{ V}$		400		

(1) Specified by characterization only.

(2) Disable time (t_{OFF}) and enable time (t_{ON}) are defined as the time interval between the 50% point of the signal applied to the SHDN pin and the point at which the output voltage reaches 10% (disable) or 90% (enable) of its final value.

(3) See Figure 5-15 for more information.

5.8 Typical Characteristics

at $T_A = 25^\circ\text{C}$, $V_S = \pm 8\text{V}$, $V_{CM} = V_S / 2$, $R_{LOAD} = 10\text{k}\Omega$ (unless otherwise noted)



Distribution from 74 amplifiers, $T_A = 25^\circ\text{C}$

Figure 5-1. Offset Voltage Production Distribution



Distribution from 74 amplifiers

Figure 5-2. Offset Voltage Drift Distribution

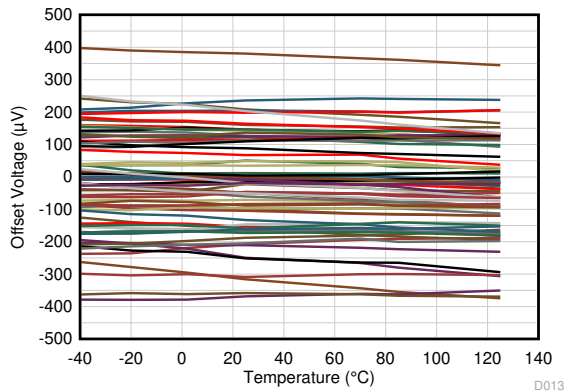

$V_{CM} = V^-$

Data from 74 amplifiers

Figure 5-3. Offset Voltage vs Temperature

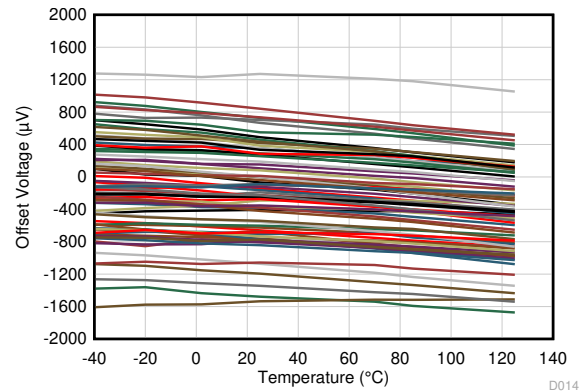

$V_{CM} = V^+$

Data from 74 amplifiers

Figure 5-4. Offset Voltage vs Temperature



$T_A = 25^\circ\text{C}$

Data from 74 amplifiers

Figure 5-5. Offset Voltage vs Common-Mode Voltage

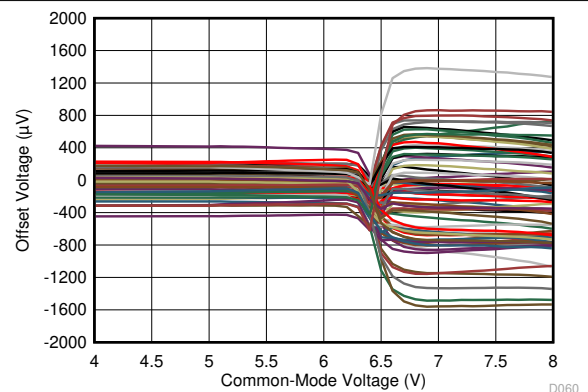

$T_A = 25^\circ\text{C}$

Data from 74 amplifiers

Figure 5-6. Offset Voltage vs Common-Mode Voltage (Transition Region)

5.8 Typical Characteristics (continued)

at $T_A = 25^\circ\text{C}$, $V_S = \pm 8\text{V}$, $V_{CM} = V_S / 2$, $R_{LOAD} = 10\text{k}\Omega$ (unless otherwise noted)



$T_A = 125^\circ\text{C}$
Data from 74 amplifiers

Figure 5-7. Offset Voltage vs Common-Mode Voltage



$T_A = 125^\circ\text{C}$
Data from 74 amplifiers

Figure 5-8. Offset Voltage vs Common-Mode Voltage (Transition Region)



$T_A = -40^\circ\text{C}$
Data from 74 amplifiers

Figure 5-9. Offset Voltage vs Common-Mode Voltage



$T_A = -40^\circ\text{C}$
Data from 74 amplifiers

Figure 5-10. Offset Voltage vs Common-Mode Voltage (Transition Region)



$V_{CM} = V^-$
Data from 74 amplifiers

Figure 5-11. Offset Voltage vs Power Supply



Figure 5-12. Closed-Loop Gain vs Frequency

5.8 Typical Characteristics (continued)

at $T_A = 25^\circ\text{C}$, $V_S = \pm 8\text{V}$, $V_{CM} = V_S / 2$, $R_{LOAD} = 10\text{k}\Omega$ (unless otherwise noted)

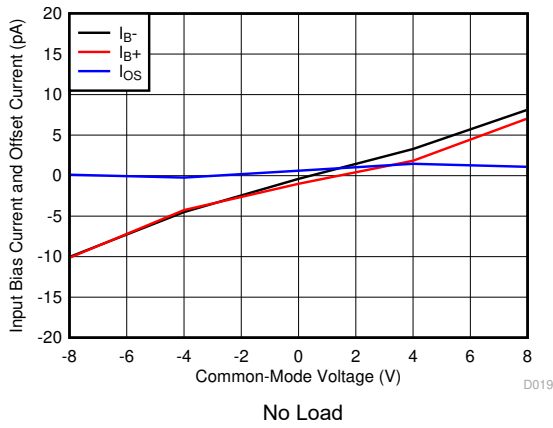

Figure 5-13. Input Bias Current and Offset Current vs Common-Mode Voltage

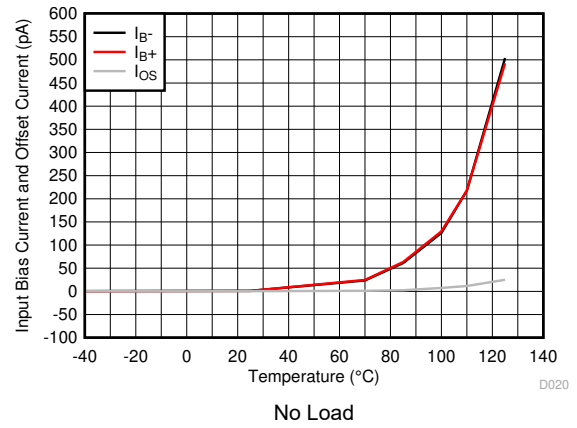

Figure 5-14. Input Bias Current and Offset Current vs Temperature

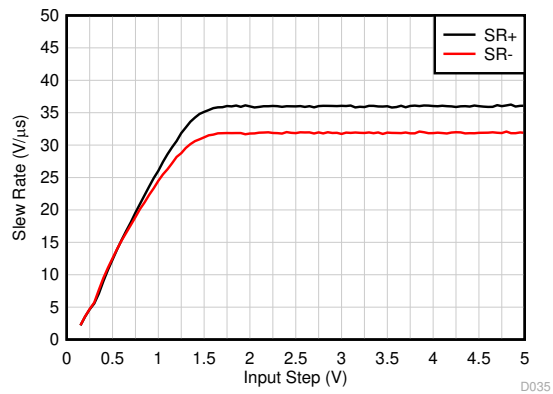

Figure 5-15. Slew Rate vs Input Step Voltage

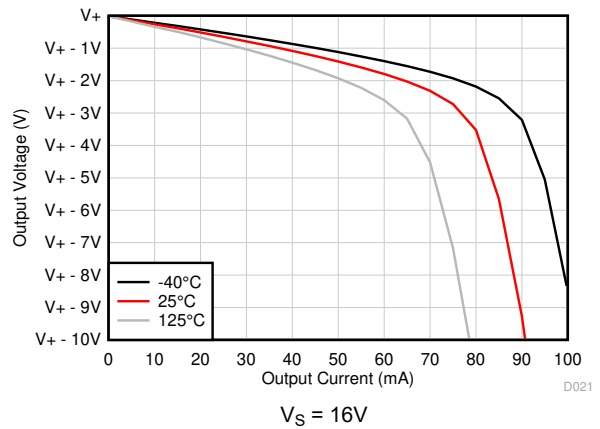

Figure 5-16. Output Voltage Swing vs Output Current (Sourcing)

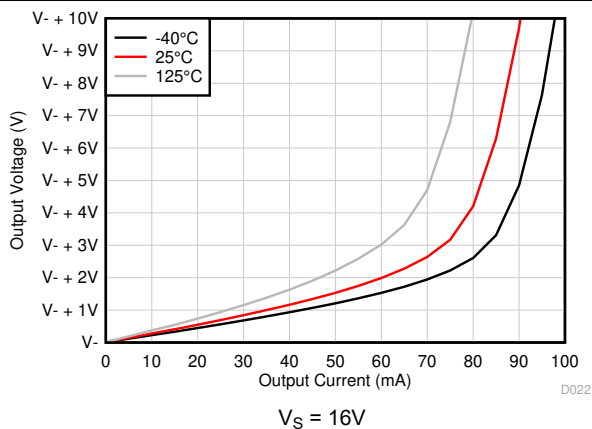

Figure 5-17. Output Voltage Swing vs Output Current (Sinking)

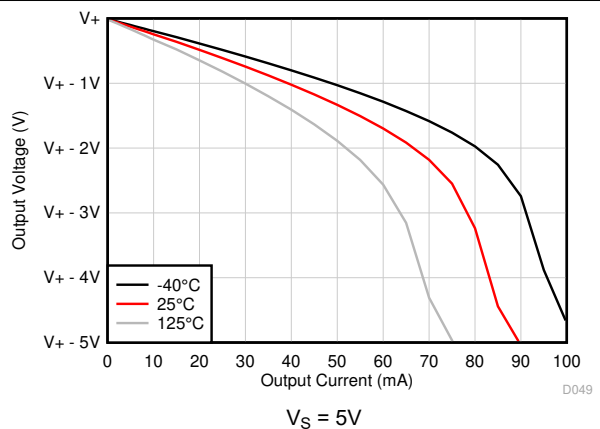

Figure 5-18. Output Voltage Swing vs Output Current (Sourcing)

5.8 Typical Characteristics (continued)

at $T_A = 25^\circ\text{C}$, $V_S = \pm 8\text{V}$, $V_{CM} = V_S / 2$, $R_{LOAD} = 10\text{k}\Omega$ (unless otherwise noted)

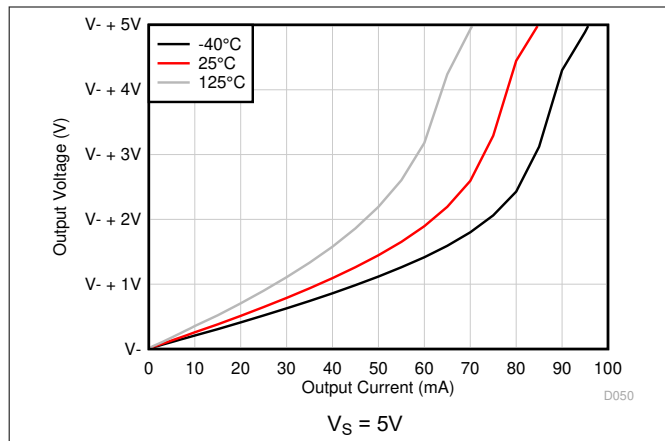

Figure 5-19. Output Voltage Swing vs Output Current (Sinking)

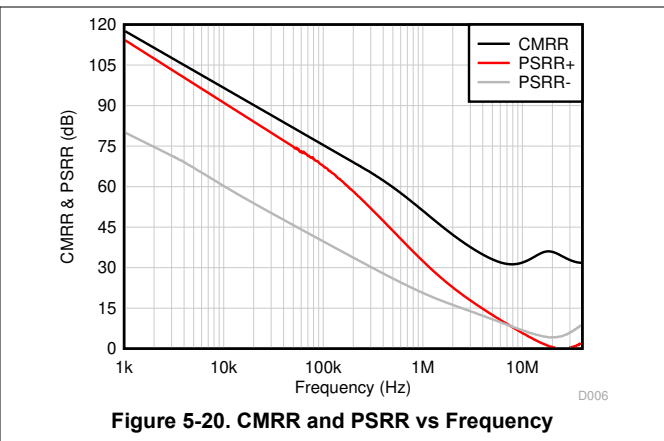

Figure 5-20. CMRR and PSRR vs Frequency

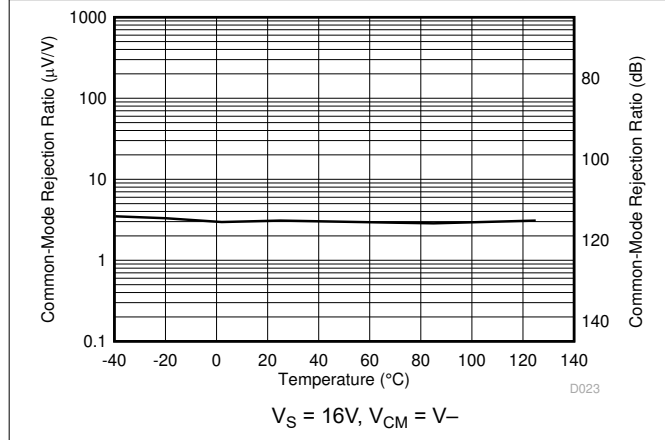

Figure 5-21. CMRR vs Temperature

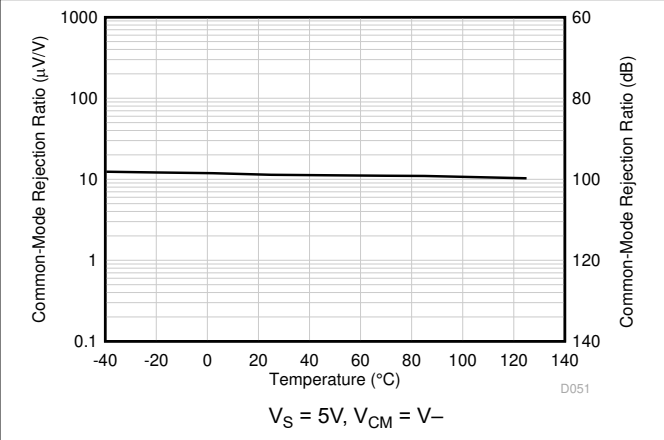

Figure 5-22. CMRR vs Temperature

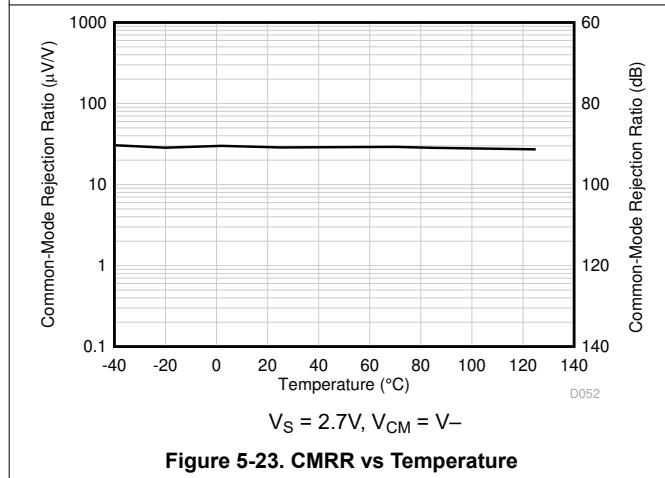

Figure 5-23. CMRR vs Temperature

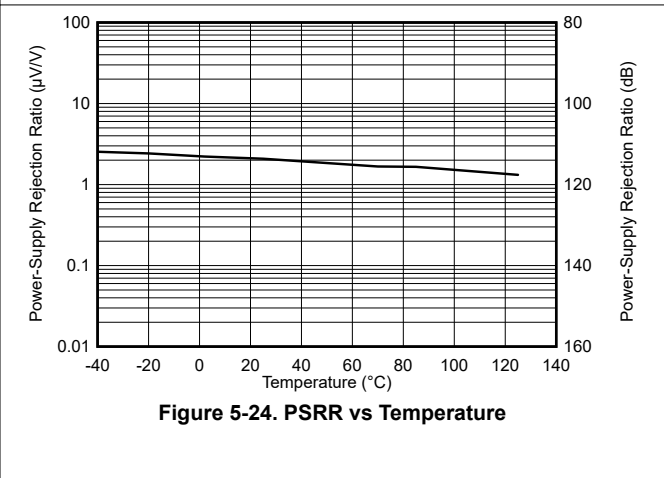
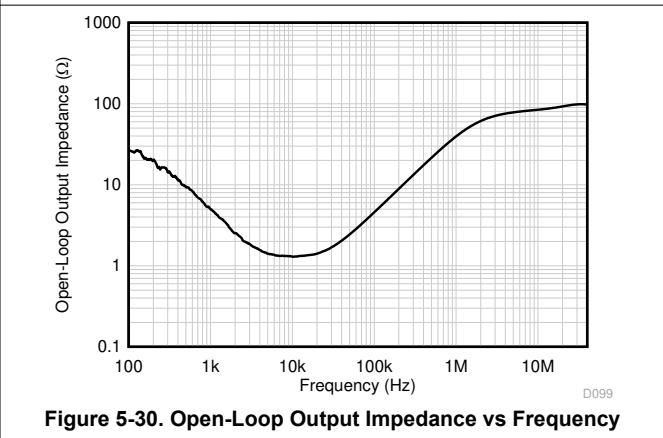
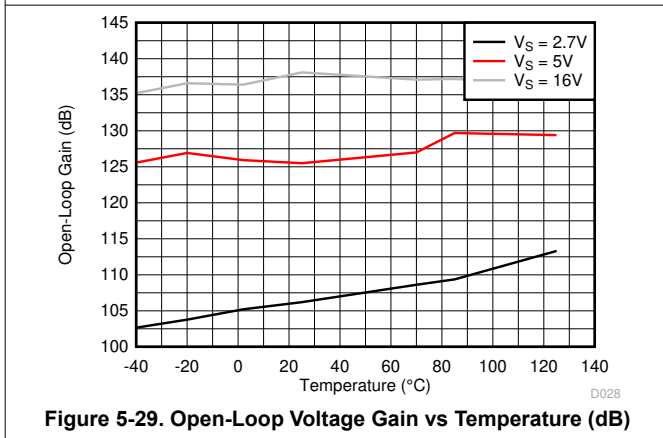
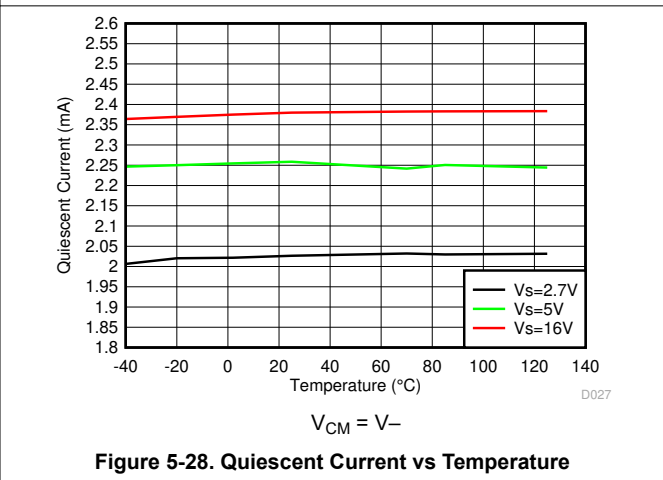
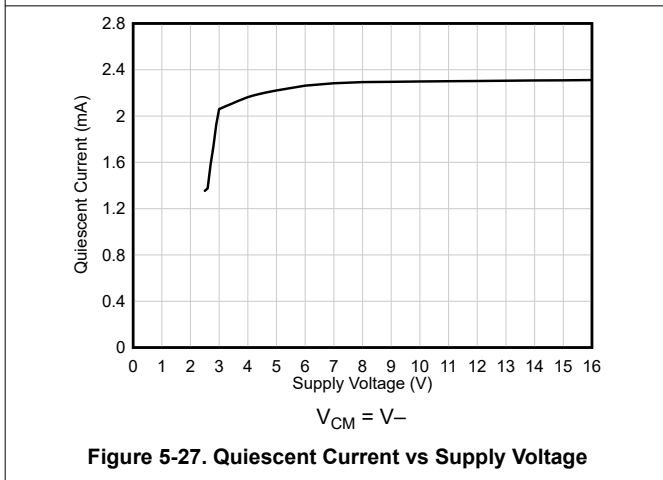
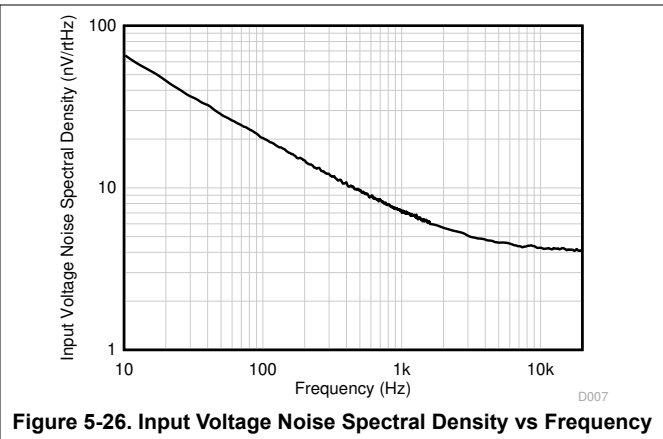
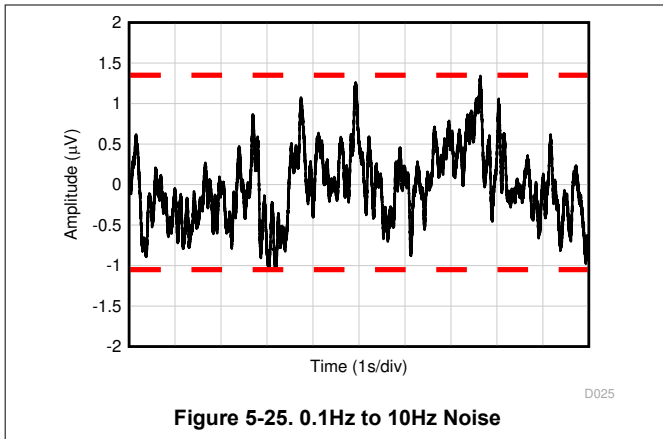

Figure 5-24. PSRR vs Temperature

5.8 Typical Characteristics (continued)

at $T_A = 25^\circ\text{C}$, $V_S = \pm 8\text{V}$, $V_{CM} = V_S / 2$, $R_{LOAD} = 10\text{k}\Omega$ (unless otherwise noted)



5.8 Typical Characteristics (continued)

at $T_A = 25^\circ\text{C}$, $V_S = \pm 8\text{V}$, $V_{CM} = V_S / 2$, $R_{LOAD} = 10\text{k}\Omega$ (unless otherwise noted)



Figure 5-31. Small-Signal Overshoot vs Capacitive Load



Figure 5-32. Small-Signal Overshoot vs Capacitive Load



Figure 5-33. Phase Margin vs Capacitive Load



Figure 5-34. Small-Signal Step Response



Figure 5-35. Small-Signal Step Response



Figure 5-36. Large-Signal Step Response

5.8 Typical Characteristics (continued)

at $T_A = 25^\circ\text{C}$, $V_S = \pm 8\text{V}$, $V_{CM} = V_S / 2$, $R_{LOAD} = 10\text{k}\Omega$ (unless otherwise noted)



$C_L = 20\text{pF}$, $G = -1$, $5V_{pp}$ step response

Figure 5-37. Large-Signal Step Response



Figure 5-38. Maximum Output Voltage vs Frequency



Figure 5-39. Channel Separation vs Frequency



Figure 5-40. EMIRR (Electromagnetic Interference Rejection Ratio) vs Frequency

6 Detailed Description

6.1 Overview

The TLV916x family (TLV9161, TLV9162, and TLV9164) is a family of 16V, general-purpose, operational amplifiers.

These devices offer excellent DC precision and AC performance, including rail-to-rail input/output, low offset ($\pm 210\mu\text{V}$, typ), low offset drift ($\pm 0.25\mu\text{V}/^\circ\text{C}$, typ), and 11MHz bandwidth.

Features such as differential and common-mode input voltage range to the supply rail, high short-circuit current ($\pm 73\text{mA}$), high slew rate ($33\text{V}/\mu\text{s}$), and shutdown make the TLV916x a flexible, robust, and high-performance operational amplifier for 16V industrial applications.

6.2 Functional Block Diagram



6.3 Feature Description

6.3.1 Input Protection Circuitry

The TLV916x uses a special input architecture to eliminate the requirement for input protection diodes but still provides robust input protection under transient conditions. Figure 6-1 shows conventional input diode protection schemes that are activated by fast transient step responses and introduce signal distortion and settling time delays because of alternate current paths, as shown in Figure 6-2. For low-gain circuits, these fast-ramping input signals forward-bias back-to-back diodes, causing an increase in input current and resulting in extended settling time.

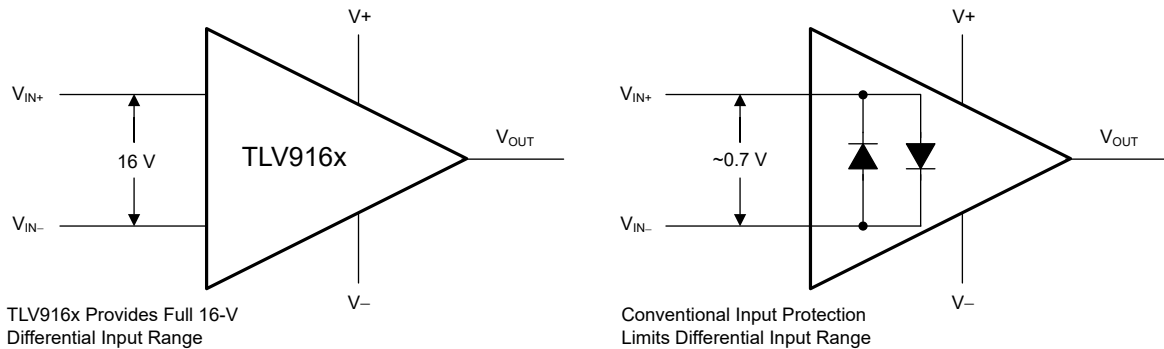

Figure 6-1. TLV916x Input Protection Does Not Limit Differential Input Capability

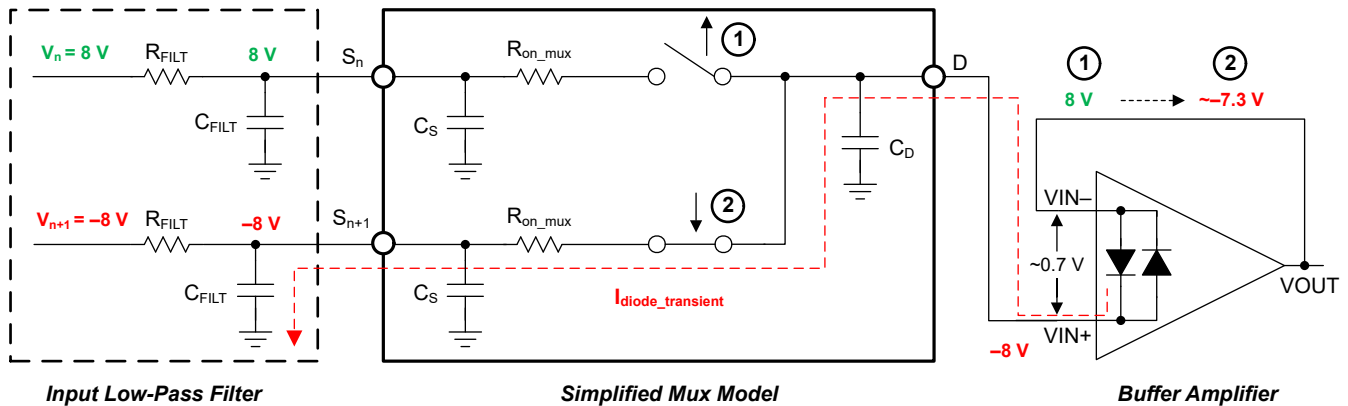

Figure 6-2. Back-to-Back Diodes Create Settling Issues

The TLV916x family of operational amplifiers provides a true high-impedance differential input capability using a patented input protection architecture that does not introduce additional signal distortion or delayed settling time, making the device an optimal op amp for multichannel, high-switched, input applications. The TLV916x tolerates a maximum differential swing (voltage between inverting and non-inverting pins of the op amp) of up to 16V, making the device suitable for use as a comparator or in applications with fast-ramping input signals such as data-acquisition systems; see the TI TechNote [MUX-Friendly Precision Operational Amplifiers](#) for more information.

6.3.2 EMI Rejection

The TLV916x uses integrated electromagnetic interference (EMI) filtering to reduce the effects of EMI from sources such as wireless communications and densely-populated boards with a mix of analog signal chain and digital components. EMI immunity can be improved with circuit design techniques; the TLV916x benefits from these design improvements. Texas Instruments has developed the ability to accurately measure and quantify the immunity of an operational amplifier over a broad frequency spectrum extending from 10MHz to 6GHz. [Figure 6-3](#) shows the results of this testing on the TLV916x. [Table 6-1](#) lists the EMIRR IN+ values for the TLV916x at particular frequencies commonly encountered in real-world applications. The [EMI Rejection Ratio of Operational Amplifiers](#) application report contains detailed information on the topic of EMIRR performance as it relates to op amps and is available for download from www.ti.com.

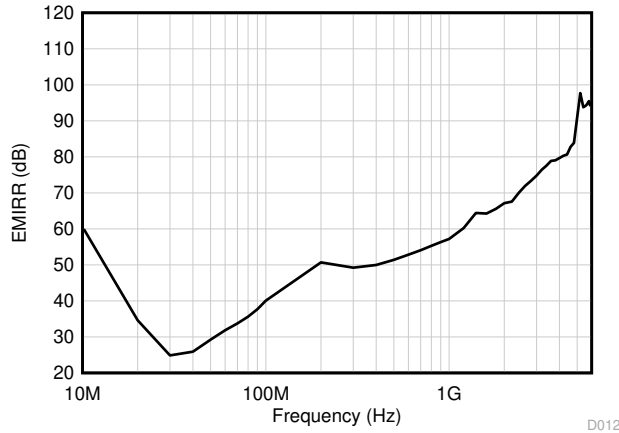

Figure 6-3. EMIRR Testing

Table 6-1. TLV9161 EMIRR IN+ for Frequencies of Interest

FREQUENCY	APPLICATION OR ALLOCATION	EMIRR IN+
400 MHz	Mobile radio, mobile satellite, space operation, weather, radar, ultra-high frequency (UHF) applications	50.0dB
900 MHz	Global system for mobile communications (GSM) applications, radio communication, navigation, GPS (to 1.6GHz), GSM, aeronautical mobile, UHF applications	56.3dB
1.8GHz	GSM applications, mobile personal communications, broadband, satellite, L-band (1GHz to 2GHz)	65.6dB
2.4GHz	802.11b, 802.11g, 802.11n, Bluetooth®, mobile personal communications, industrial, scientific and medical (ISM) radio band, amateur radio and satellite, S-band (2GHz to 4GHz)	70.0dB
3.6GHz	Radiolocation, aero communication and navigation, satellite, mobile, S-band	78.9dB
5GHz	802.11a, 802.11n, aero communication and navigation, mobile communication, space and satellite operation, C-band (4GHz to 8GHz)	91.0dB

6.3.3 Thermal Protection

The internal power dissipation of any amplifier causes its internal (junction) temperature to rise. This phenomenon is called *self heating*. The absolute maximum junction temperature of the TLV916x is 150°C. Exceeding this temperature causes damage to the device. The TLV916x has a thermal protection feature that reduces damage from self heating. The protection works by monitoring the temperature of the device and turning off the op amp output drive for temperatures above 170°C. Figure 6-4 shows an application example for the TLV9162 that has significant self heating because of its power dissipation (0.627 W). In this example, both channels have a quiescent power dissipation while one of the channels has a significant load. Thermal calculations indicate that for an ambient temperature of 60°C, the device junction temperature reaches 175°C. The actual device, however, turns off the output drive to recover towards a safe junction temperature. Figure 6-4 shows how the circuit behaves during thermal protection. During normal operation, the device acts as a buffer so the output is 5V. When self heating causes the device junction temperature to increase above the internal limit, the thermal protection forces the output to a high-impedance state and the output is pulled to ground through resistor R_L . If the condition that caused excessive power dissipation is not removed, the amplifier will oscillate between a shutdown and enabled state until the output fault is corrected. Please note that thermal performance can vary greatly depending on the package selected and the PCB layout design. This example uses the thermal performance of the TSSOP (8) package.

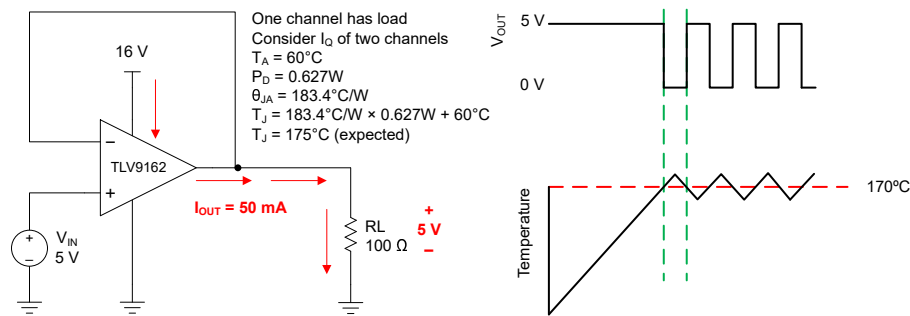

Figure 6-4. Thermal Protection

6.3.4 Capacitive Load and Stability

The TLV916x features an output stage capable of driving moderate capacitive loads, and by leveraging an isolation resistor, the device can easily be configured to drive larger capacitive loads. Increasing the gain enhances the ability of the amplifier to drive greater capacitive loads; see Figure 6-5 and Figure 6-6. The particular op amp circuit configuration, layout, gain, and output loading are some of the factors to consider when establishing whether an amplifier will be stable in operation.



Figure 6-5. Small-Signal Overshoot vs Capacitive Load (20-mV_{pp} Output Step, G = +1)



Figure 6-6. Small-Signal Overshoot vs Capacitive Load (20-mV_{pp} Output Step, G = -1)

6.3.6 Phase Reversal Protection

The TLV916x family has internal phase-reversal protection. Many op amps exhibit a phase reversal when the input is driven beyond its linear common-mode range. This condition is most often encountered in non-inverting circuits when the input is driven beyond the specified common-mode voltage range, causing the output to reverse into the opposite rail. The TLV916x is a rail-to-rail input op amp; therefore, the common-mode range can extend up to the rails. Input signals beyond the rails do not cause phase reversal; instead, the output limits into the appropriate rail. For more information on phase reversal, see [Op Amps With Complementary-Pair Input Stages](#) application note.

6.3.7 Electrical Overstress

Designers often ask questions about the capability of an operational amplifier to withstand electrical overstress (EOS). These questions tend to focus on the device inputs, but may involve the supply voltage pins or even the output pin. Each of these different pin functions have electrical stress limits determined by the voltage breakdown characteristics of the particular semiconductor fabrication process and specific circuits connected to the pin. Additionally, internal electrostatic discharge (ESD) protection is built into these circuits to protect them from accidental ESD events both before and during product assembly.

Having a good understanding of this basic ESD circuitry and its relevance to an electrical overstress event is helpful. [Figure 6-9](#) shows an illustration of the ESD circuits contained in the TLV916x (indicated by the dashed line area). The ESD protection circuitry involves several current-steering diodes connected from the input and output pins and routed back to the internal power-supply lines, where the diodes meet at an absorption device or the power-supply ESD cell, internal to the operational amplifier. This protection circuitry is intended to remain inactive during normal circuit operation.

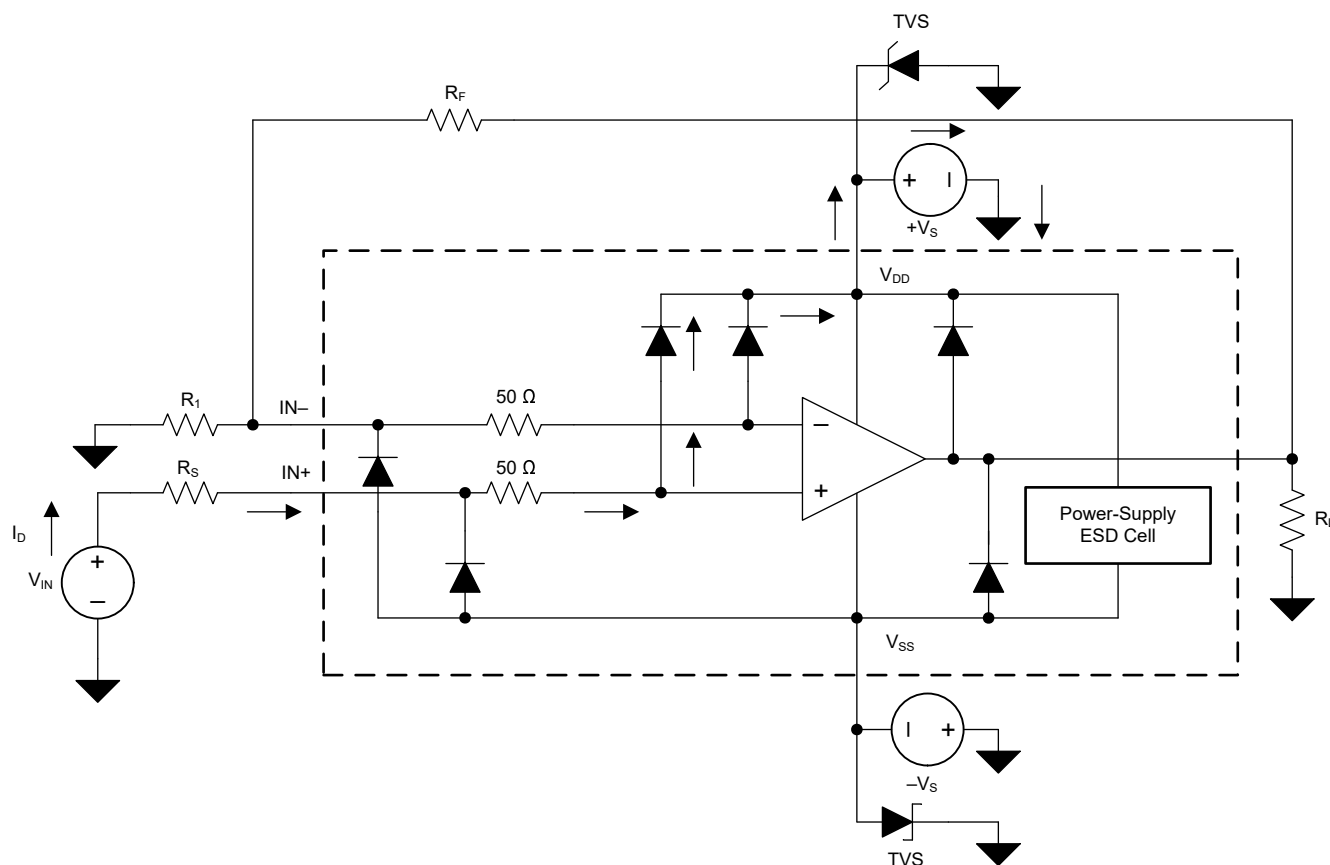

Figure 6-9. Equivalent Internal ESD Circuitry Relative to a Typical Circuit Application

An ESD event is very short in duration and very high voltage (for example; 1kV, 100 ns), whereas an EOS event is long duration and lower voltage (for example; 50V, 100 ms). The ESD diodes are designed for out-of-circuit ESD protection (that is, during assembly, test, and storage of the device before being soldered to the PCB). During an ESD event, the ESD signal is passed through the ESD steering diodes to an absorption circuit (labeled ESD power-supply circuit). The ESD absorption circuit clamps the supplies to a safe level.

Although this behavior is necessary for out-of-circuit protection, excessive current and damage is caused if activated in-circuit. A transient voltage suppressors (TVS) can be used to prevent against damage caused by turning on the ESD absorption circuit during an in-circuit ESD event. Using the appropriate current limiting resistors and TVS diodes allows for the use of device ESD diodes to protect against EOS events.

6.3.8 Overload Recovery

Overload recovery is defined as the time required for the op amp output to recover from a saturated state to a linear state. The output devices of the op amp enter a saturation region when the output voltage exceeds the rated operating voltage, either due to the high input voltage or the high gain. After the device enters the saturation region, the charge carriers in the output devices require time to return back to the linear state. After the charge carriers return back to the linear state, the device begins to slew at the specified slew rate. Thus, the propagation delay in case of an overload condition is the sum of the overload recovery time and the slew time. The overload recovery time for the TLV916x is approximately 120ns.

6.3.9 Typical Specifications and Distributions

Designers often have questions about a typical specification of an amplifier in order to design a more robust circuit. Due to natural variation in process technology and manufacturing procedures, every specification of an amplifier will exhibit some amount of deviation from the ideal value, like an amplifier's input offset voltage. These deviations often follow *Gaussian* ("bell curve"), or *normal* distributions, and circuit designers can leverage this information to guardband their system, even when there is not a minimum or maximum specification in the [Electrical Characteristics](#) table.



Figure 6-10. Ideal Gaussian Distribution

Figure 6-10 shows an example distribution, where μ , or mu , is the mean of the distribution, and where σ , or $sigma$, is the standard deviation of a system. For a specification that exhibits this kind of distribution, approximately two-thirds (68.26%) of all units can be expected to have a value within one standard deviation, or one sigma, of the mean (from $\mu - \sigma$ to $\mu + \sigma$).

Depending on the specification, values listed in the *typical* column of the *Electrical Characteristics* table are represented in different ways. As a general rule of thumb, if a specification naturally has a nonzero mean (for example, like gain bandwidth), then the typical value is equal to the mean (μ). However, if a specification naturally has a mean near zero (like input offset voltage), then the typical value is equal to the mean plus one standard deviation ($\mu + \sigma$) in order to most accurately represent the typical value.

You can use this chart to calculate approximate probability of a specification in a unit; for example, for TLV916x, the typical input voltage offset is 210 μ V, so 68.2% of all TLV916x devices are expected to have an offset from -210μ V to 210 μ V. At 4 σ ($\pm 840\mu$ V), 99.9937% of the distribution has an offset voltage less than $\pm 840\mu$ V, which means 0.0063% of the population is outside of these limits, which corresponds to about 1 in 15,873 units.

Specifications with a value in the minimum or maximum column are specified by TI, and units outside these limits will be removed from production material. For example, the TLV916x family has a maximum offset voltage of 1mV at 25°C, and even though this corresponds to about 5- σ (≈ 1 in 1.7 million units), which is extremely unlikely, any unit with larger offset than 1mV will be removed from production material.

For specifications with no value in the minimum or maximum column, consider selecting a sigma value of sufficient guardband for the application, and design worst-case conditions using this value. For example, the 6- σ value corresponds to about 1 in 500 million units, which is an extremely unlikely chance, and could be an option as a wide guardband to design a system around. In this case, the TLV916x family does not have a maximum or minimum for offset voltage drift, but based on the typical value of 0.25 μ V/°C in the *Electrical Characteristics* table, it can be calculated that the 6- σ value for offset voltage drift is about 1.5 μ V/°C. When designing for worst-case system conditions, this value can be used to estimate the worst possible offset across temperature without having an actual minimum or maximum value.

However, process variation and adjustments over time can shift typical means and standard deviations, and unless there is a value in the minimum or maximum specification column, TI cannot assure the performance of a device. This information should be used only to estimate the performance of a device.

6.3.10 Packages With an Exposed Thermal Pad

The TLV916x family is available in the WSON-8 (DSG) package which features an exposed thermal pad. Inside the package, the die is attached to this thermal pad using an electrically conductive compound. For this reason, when using a package with an exposed thermal pad, the thermal pad must either be connected to V $-$ or left floating. Attaching the thermal pad to a potential other than V $-$ is not allowed, and performance of the device is not assured when doing so.

6.3.11 Shutdown

The TLV916xS devices feature one or more shutdown pins (SHDN) that disable the op amp, placing it into a low-power standby mode. In this mode, the op amp typically consumes about 36 μ A. The SHDN pins are active high, meaning that shutdown mode is enabled when the input to the SHDN pin is a valid logic high. The amplifier is enabled when the input to the SHDN pin is a valid logic low.

The SHDN pins are referenced to the negative supply rail of the op amp. The threshold of the shutdown feature lies around 800mV (typical) and does not change with respect to the supply voltage. Hysteresis has been included in the switching threshold for smooth switching characteristics. For optimal shutdown behavior, the SHDN pins should be driven with valid logic signals. A valid logic low is defined as a voltage between V $-$ and V $-$ + 0.2V. A valid logic high is defined as a voltage between V $-$ + 1.1V and V $+$. The shutdown pin circuitry includes a pull-down resistor, which will inherently pull the voltage of the pin to the negative supply rail if not driven. Thus, to enable the amplifier, the SHDN pins should either be left floating or driven to a valid logic low. To disable the amplifier, the SHDN pins must be driven to a valid logic high. The maximum voltage allowed at the SHDN pins is V $+$. Exceeding V $+$ will damage the device.

The SHDN pins are high-impedance CMOS inputs. Channels of single and dual op amp packages are independently controlled, and channels of quad op amp packages are controlled in pairs. For battery-operated applications, this feature may be used to greatly reduce the average current and extend battery life. The typical enable time out of shutdown is 5 μ s; disable time is 3 μ s. When disabled, the output assumes a high-impedance state. This architecture allows the TLV916xS family to operate as a gated amplifier, multiplexer, or programmable-gain amplifier. Shutdown time (t_{OFF}) depends on loading conditions and increases as load resistance increases. To shutdown (disable) the device within a specific shutdown time, the specified 10k Ω load to V– is required. If using the TLV916xS without a load, the resulting turnoff time significantly increases.

6.4 Device Functional Modes

The TLV916x has a single functional mode and is operational when the power-supply voltage is greater than 2.7V (± 1.35 V). The maximum power supply voltage for the TLV916x is 16V (± 8 V).

The TLV916xS devices feature a shutdown pin, which can be used to place the op amp into a low-power mode. See [Shutdown](#) section for more information.

7 Application and Implementation

Note

Information in the following applications sections is not part of the TI component specification, and TI does not warrant its accuracy or completeness. TI's customers are responsible for determining suitability of components for their purposes, as well as validating and testing their design implementation to confirm system functionality.

7.1 Application Information

The TLV916x family offers excellent DC precision and AC performance. These devices operate up to 16V supply rails and offer true rail-to-rail input/output, low offset voltage and offset voltage drift, as well as 11MHz bandwidth and high output drive. These features make the TLV916x a robust, high-performance operational amplifier for 16V industrial applications.

7.2 Typical Applications

7.2.1 Low-Side Current Measurement

Figure 7-1 shows the TLV9161 configured in a low-side current sensing application. For a full analysis of the circuit shown in Figure 7-1 including theory, calculations, simulations, and measured data, see TI Precision Design TIPD129, *0-A to 1-A Single-Supply Low-Side Current-Sensing Solution*.

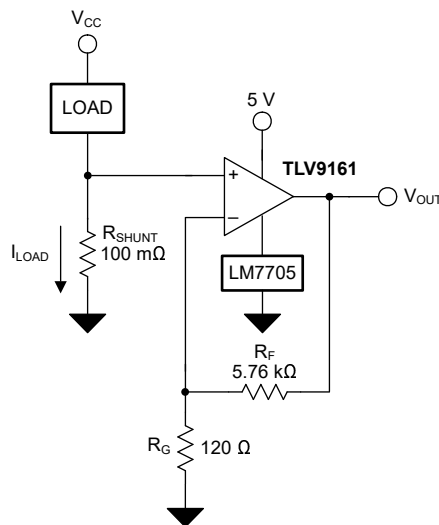

Figure 7-1. TLV9161 in a Low-Side, Current-Sensing Application

7.2.1.1 Design Requirements

The design requirements for this design are:

- Load current: 0A to 1A
- Output voltage: 4.9V
- Maximum shunt voltage: 100mV

7.2.1.2 Detailed Design Procedure

The transfer function of the circuit in [Figure 7-1](#) is given in [Equation 1](#).

$$V_{OUT} = I_{LOAD} \times R_{SHUNT} \times \text{Gain} \quad (1)$$

The load current (I_{LOAD}) produces a voltage drop across the shunt resistor (R_{SHUNT}). The load current is set from 0A to 1A. To keep the shunt voltage below 100mV at maximum load current, the largest shunt resistor is defined using [Equation 2](#).

$$R_{SHUNT} = \frac{V_{SHUNT_MAX}}{I_{LOAD_MAX}} = \frac{100\text{mV}}{1\text{A}} = 100\text{m}\Omega \quad (2)$$

Using [Equation 2](#), R_{SHUNT} is calculated to be 100m Ω . The voltage drop produced by I_{LOAD} and R_{SHUNT} is amplified by the TLV9161 to produce an output voltage of 0V to 4.9V. The gain needed by the TLV9161 to produce the necessary output voltage is calculated using [Equation 3](#).

$$\text{Gain} = \frac{(V_{OUT_MAX} - V_{OUT_MIN})}{(V_{IN_MAX} - V_{IN_MIN})} \quad (3)$$

Using [Equation 3](#), the required gain is calculated to be 49V/V, which is set with resistors R_F and R_G . [Equation 4](#) is used to size the resistors, R_F and R_G , to set the gain of the TLV9161 to 49V/V.

$$\text{Gain} = 1 + \frac{(R_F)}{(R_G)} \quad (4)$$

Choosing R_F as 5.76k Ω , R_G is calculated to be 120 Ω . R_F and R_G were chosen as 5.76k Ω and 120 Ω because they are standard value resistors that create a 49:1 ratio. Other resistors that create a 49:1 ratio can also be used. However, excessively large resistors will generate thermal noise that exceeds the intrinsic noise of the op amp [Figure 7-2](#) shows the measured transfer function of the circuit shown in [Figure 7-1](#).

7.2.1.3 Application Curve



Figure 7-2. Low-Side, Current-Sense, Transfer Function

7.2.2 Buffered Multiplexer

The TLV916xS shutdown devices can be configured to create a buffered multiplexer. Outputs can be connected together on a common bus and the shutdown pins can be used to select the desired channel to pass through. Since the amplifier circuitry has been designed such that disable transitions occur faster than enable transitions, the amplifier naturally exhibits a "break before make" switch topology. Amplifier outputs enter a high impedance state when placed in shutdown, so there is no risk of bus contention when connecting multiple channel outputs together. Additionally, because outputs are isolated from inputs, there is no concern about the impedance at the input of each channel interacting undesirably with the impedance at the output, like an amplifier gain stage or ADC driver circuit. Also, because this topology uses amplifiers instead of MOSFET switches, other common issues with multiplexers such as charge injection or signal error due to R_{ON} effects are eliminated.

Figure 7-3 shows an example topology for a basic 2:1 multiplexer. When SEL is low, channel 1 is selected and active; when SEL is high, channel 2 is selected and active. For more information on how to use the TLV916xS shutdown function, see the shutdown section in [Section 6.3.11](#)



Figure 7-3. Precision Reference Buffer

7.3 Power Supply Recommendations

The TLV916x is specified for operation from 2.7V to 16V ($\pm 1.35V$ to $\pm 8V$); many specifications apply from $-40^{\circ}C$ to $125^{\circ}C$ or with specific supply voltage and test conditions.

CAUTION

Supply voltages larger than 20V can permanently damage the device; see the [Absolute Maximum Ratings](#) section.

Place 0.1 μ F bypass capacitors close to the power-supply pins to reduce errors coupling in from noisy or high-impedance power supplies. For more detailed information on bypass capacitor placement, refer to the [Layout](#) section.

7.4 Layout

7.4.1 Layout Guidelines

For best operational performance of the device, use good PCB layout practices, including:

- Noise can propagate into analog circuitry through the power pins of the circuit as a whole and op amp itself. Bypass capacitors are used to reduce the coupled noise by providing low-impedance power sources local to the analog circuitry.
 - Connect low-ESR, 0.1 μ F ceramic bypass capacitors between each supply pin and ground, placed as close to the device as possible. A single bypass capacitor from V+ to ground is applicable for single-supply applications.

- Separate grounding for analog and digital portions of circuitry is one of the simplest and most-effective methods of noise suppression. One or more layers on multilayer PCBs are usually devoted to ground planes. A ground plane helps distribute heat and reduces EMI noise pickup. Make sure to physically separate digital and analog grounds paying attention to the flow of the ground current.
- In order to reduce parasitic coupling, run the input traces as far away from the supply or output traces as possible. If these traces cannot be kept separate, crossing the sensitive trace perpendicular is much better as opposed to in parallel with the noisy trace.
- Place the external components as close to the device as possible. As shown in [Figure 7-5](#), keeping RF and RG close to the inverting input minimizes parasitic capacitance.
- Keep the length of input traces as short as possible. Always remember that the input traces are the most sensitive part of the circuit.
- Consider a driven, low-impedance guard ring around the critical traces. A guard ring can significantly reduce leakage currents from nearby traces that are at different potentials.
- Cleaning the PCB following board assembly is recommended for best performance.
- Any precision integrated circuit may experience performance shifts due to moisture ingress into the plastic package. Following any aqueous PCB cleaning process, baking the PCB assembly is recommended to remove moisture introduced into the device packaging during the cleaning process. A low temperature, post cleaning bake at 85°C for 30 minutes is sufficient for most circumstances.

7.4.2 Layout Example



Figure 7-4. Schematic for Noninverting Configuration Layout Example



Figure 7-5. Operational Amplifier Board Layout for Noninverting Configuration - SC70 (DCK) Package

8 Device and Documentation Support

8.1 Device Support

8.1.1 Development Support

8.1.1.1 TINA-TI™ (Free Software Download)

TINA™ is a simple, powerful, and easy-to-use circuit simulation program based on a SPICE engine. TINA-TI is a free, fully-functional version of the TINA software, preloaded with a library of macro models in addition to a range of both passive and active models. TINA-TI provides all the conventional dc, transient, and frequency domain analysis of SPICE, as well as additional design capabilities.

Available as a [free download](#) from the Analog eLab Design Center, TINA-TI offers extensive post-processing capability that allows users to format results in a variety of ways. Virtual instruments offer the ability to select input waveforms and probe circuit nodes, voltages, and waveforms, creating a dynamic quick-start tool.

Note

These files require that either the TINA software (from DesignSoft™) or TINA-TI software be installed. Download the free TINA-TI software from the [TINA-TI folder](#).

8.2 Documentation Support

8.2.1 Related Documentation

For related documentation, see the following:

- Texas Instruments, [Analog Engineer's Circuit Cookbook: Amplifiers](#)
- Texas Instruments, [AN31 amplifier circuit collection application note](#)
- Texas Instruments, [MUX-Friendly, Precision Operational Amplifiers application brief](#)
- Texas Instruments, [EMI Rejection Ratio of Operational Amplifiers application note](#)
- Texas Instruments, [Op Amps With Complementary-Pair Input Stages application note](#)

8.3 Receiving Notification of Documentation Updates

To receive notification of documentation updates, navigate to the device product folder on [ti.com](#). Click on *Notifications* to register and receive a weekly digest of any product information that has changed. For change details, review the revision history included in any revised document.

8.4 Support Resources

[TI E2E™ support forums](#) are an engineer's go-to source for fast, verified answers and design help — straight from the experts. Search existing answers or ask your own question to get the quick design help you need.

Linked content is provided "AS IS" by the respective contributors. They do not constitute TI specifications and do not necessarily reflect TI's views; see TI's [Terms of Use](#).

8.5 Trademarks

TINA-TI™ is a trademark of Texas Instruments, Inc and DesignSoft, Inc.

TINA™ and DesignSoft™ are trademarks of DesignSoft, Inc.

TI E2E™ is a trademark of Texas Instruments.

Bluetooth® is a registered trademark of Bluetooth SIG, Inc.

All trademarks are the property of their respective owners.

8.6 Electrostatic Discharge Caution



This integrated circuit can be damaged by ESD. Texas Instruments recommends that all integrated circuits be handled with appropriate precautions. Failure to observe proper handling and installation procedures can cause damage.

ESD damage can range from subtle performance degradation to complete device failure. Precision integrated circuits may be more susceptible to damage because very small parametric changes could cause the device not to meet its published specifications.

8.7 Glossary

[TI Glossary](#) This glossary lists and explains terms, acronyms, and definitions.

9 Revision History

NOTE: Page numbers for previous revisions may differ from page numbers in the current version.

Changes from Revision C (January 2024) to Revision D (March 2024)	Page
• Added PSRR values for TLV9162SIRUGR.....	9

Changes from Revision B (August 2022) to Revision C (January 2024)	Page
• Removed preview notation from TLV9164 X2QFN (10) package from <i>Device Information</i> table.....	1

Changes from Revision A (December 2021) to Revision B (August 2022)	Page
• Added TLV9162 X2QFN (10) package to <i>Device Information</i> table with preview status.....	1
• Added TLV9162 X2QFN package (RUG) to the <i>Pin Configuration and Functions</i> section with preview status.....	3
• Added V_{IH} and V_{IL} in <i>Recommended Operating Conditions</i> section.....	7
• Added SHUTDOWN in <i>Electrical Characteristics</i> table.....	7

Changes from Revision * (November 2021) to Revision A (December 2021)	Page
• Removed preview notation from TLV9164 SOIC (14) package from <i>Device Information</i> table.....	1
• Removed preview notation from TLV9164 TSSOP (14) package from <i>Device Information</i> table.....	1
• Removed preview notation from TLV9164 D package (SOIC) in the <i>Pin Configuration and Functions</i> section.....	3
• Removed preview notation from TLV9164 PW package (TSSOP) in the <i>Pin Configuration and Functions</i> section.....	3
• Removed preview notation from TLV9164 D package (SOIC) in the <i>Thermal Information for Quad Channel</i> section.....	8
• Removed preview notation from TLV9164 PW package (TSSOP) in the <i>Thermal Information for Quad Channel</i> section.....	8
• Added PSRR specification for TLV9164 release in <i>Electrical Characteristics</i> section.....	9
• Added clarification to $V_S = 2.7\text{ V to }16\text{ V}$ PSRR specification noting that specification is for all channel variants.....	9

10 Mechanical, Packaging, and Orderable Information

The following pages include mechanical, packaging, and orderable information. This information is the most current data available for the designated devices. This data is subject to change without notice and revision of this document. For browser-based versions of this data sheet, refer to the left-hand navigation.

PACKAGING INFORMATION

Orderable part number	Status (1)	Material type (2)	Package Pins	Package qty Carrier	RoHS (3)	Lead finish/ Ball material (4)	MSL rating/ Peak reflow (5)	Op temp (°C)	Part marking (6)
TLV9161IDBVR	Active	Production	SOT-23 (DBV) 5	3000 LARGE T&R	Yes	NIPDAU SN	Level-1-260C-UNLIM	-40 to 125	T61DB
TLV9161IDBVR.A	Active	Production	SOT-23 (DBV) 5	3000 LARGE T&R	Yes	NIPDAU	Level-1-260C-UNLIM	-40 to 125	T61DB
TLV9161IDCKR	Active	Production	SC70 (DCK) 5	3000 LARGE T&R	Yes	SN	Level-1-260C-UNLIM	-40 to 125	1JT
TLV9161IDCKR.A	Active	Production	SC70 (DCK) 5	3000 LARGE T&R	Yes	SN	Level-1-260C-UNLIM	-40 to 125	1JT
TLV9161SIDBVR	Active	Production	SOT-23 (DBV) 6	3000 LARGE T&R	Yes	NIPDAU SN	Level-1-260C-UNLIM	-40 to 125	T91SD
TLV9161SIDBVR.A	Active	Production	SOT-23 (DBV) 6	3000 LARGE T&R	Yes	NIPDAU	Level-1-260C-UNLIM	-40 to 125	T91SD
TLV9162IDDFR	Active	Production	SOT-23-THIN (DDF) 8	3000 LARGE T&R	Yes	NIPDAU	Level-1-260C-UNLIM	-40 to 125	2ICF
TLV9162IDDFR.A	Active	Production	SOT-23-THIN (DDF) 8	3000 LARGE T&R	Yes	NIPDAU	Level-1-260C-UNLIM	-40 to 125	2ICF
TLV9162IDGKR	Active	Production	VSSOP (DGK) 8	2500 LARGE T&R	Yes	SN	Level-1-260C-UNLIM	-40 to 125	2JVT
TLV9162IDGKR.A	Active	Production	VSSOP (DGK) 8	2500 LARGE T&R	Yes	SN	Level-1-260C-UNLIM	-40 to 125	2JVT
TLV9162IDR	Active	Production	SOIC (D) 8	3000 LARGE T&R	Yes	NIPDAU	Level-1-260C-UNLIM	-40 to 125	T9162D
TLV9162IDR.A	Active	Production	SOIC (D) 8	3000 LARGE T&R	Yes	NIPDAU	Level-1-260C-UNLIM	-40 to 125	T9162D
TLV9162IDSGR	Active	Production	WSON (DSG) 8	3000 LARGE T&R	Yes	NIPDAU	Level-1-260C-UNLIM	-40 to 125	2HZH
TLV9162IDSGR.A	Active	Production	WSON (DSG) 8	3000 LARGE T&R	Yes	NIPDAU	Level-1-260C-UNLIM	-40 to 125	2HZH
TLV9162IPWR	Active	Production	TSSOP (PW) 8	3000 LARGE T&R	Yes	NIPDAU	Level-1-260C-UNLIM	-40 to 125	T9162P
TLV9162IPWR.A	Active	Production	TSSOP (PW) 8	3000 LARGE T&R	Yes	NIPDAU	Level-1-260C-UNLIM	-40 to 125	T9162P
TLV9162SIRUGR	Active	Production	X2QFN (RUG) 10	3000 LARGE T&R	Yes	NIPDAU	Level-1-260C-UNLIM	-40 to 125	1NA
TLV9162SIRUGR.A	Active	Production	X2QFN (RUG) 10	3000 LARGE T&R	Yes	NIPDAU	Level-1-260C-UNLIM	-40 to 125	1NA
TLV9164IDR	Active	Production	SOIC (D) 14	3000 LARGE T&R	Yes	NIPDAU	Level-1-260C-UNLIM	-40 to 125	TLV9164D
TLV9164IDR.A	Active	Production	SOIC (D) 14	3000 LARGE T&R	Yes	NIPDAU	Level-1-260C-UNLIM	-40 to 125	TLV9164D
TLV9164IPWR	Active	Production	TSSOP (PW) 14	3000 LARGE T&R	Yes	NIPDAU SN	Level-1-260C-UNLIM	-40 to 125	T9164PW
TLV9164IPWR.A	Active	Production	TSSOP (PW) 14	3000 LARGE T&R	Yes	NIPDAU	Level-1-260C-UNLIM	-40 to 125	T9164PW

(1) **Status:** For more details on status, see our [product life cycle](#).

(2) **Material type:** When designated, preproduction parts are prototypes/experimental devices, and are not yet approved or released for full production. Testing and final process, including without limitation quality assurance, reliability performance testing, and/or process qualification, may not yet be complete, and this item is subject to further changes or possible discontinuation. If available for ordering, purchases will be subject to an additional waiver at checkout, and are intended for early internal evaluation purposes only. These items are sold without warranties of any kind.

(3) **RoHS values:** Yes, No, RoHS Exempt. See the [TI RoHS Statement](#) for additional information and value definition.

(4) **Lead finish/Ball material:** Parts may have multiple material finish options. Finish options are separated by a vertical ruled line. Lead finish/Ball material values may wrap to two lines if the finish value exceeds the maximum column width.

(5) **MSL rating/Peak reflow:** The moisture sensitivity level ratings and peak solder (reflow) temperatures. In the event that a part has multiple moisture sensitivity ratings, only the lowest level per JEDEC standards is shown. Refer to the shipping label for the actual reflow temperature that will be used to mount the part to the printed circuit board.

(6) **Part marking:** There may be an additional marking, which relates to the logo, the lot trace code information, or the environmental category of the part.

Multiple part markings will be inside parentheses. Only one part marking contained in parentheses and separated by a "~" will appear on a part. If a line is indented then it is a continuation of the previous line and the two combined represent the entire part marking for that device.

Important Information and Disclaimer: The information provided on this page represents TI's knowledge and belief as of the date that it is provided. TI bases its knowledge and belief on information provided by third parties, and makes no representation or warranty as to the accuracy of such information. Efforts are underway to better integrate information from third parties. TI has taken and continues to take reasonable steps to provide representative and accurate information but may not have conducted destructive testing or chemical analysis on incoming materials and chemicals. TI and TI suppliers consider certain information to be proprietary, and thus CAS numbers and other limited information may not be available for release.

In no event shall TI's liability arising out of such information exceed the total purchase price of the TI part(s) at issue in this document sold by TI to Customer on an annual basis.

OTHER QUALIFIED VERSIONS OF TLV9161, TLV9162, TLV9164 :

- Automotive : [TLV9161-Q1](#), [TLV9162-Q1](#), [TLV9164-Q1](#)

NOTE: Qualified Version Definitions:

- Automotive - Q100 devices qualified for high-reliability automotive applications targeting zero defects

TAPE AND REEL INFORMATION

QUADRANT ASSIGNMENTS FOR PIN 1 ORIENTATION IN TAPE

*All dimensions are nominal

Device	Package Type	Package Drawing	Pins	SPQ	Reel Diameter (mm)	Reel Width W1 (mm)	A0 (mm)	B0 (mm)	K0 (mm)	P1 (mm)	W (mm)	Pin1 Quadrant
TLV9161IDBVR	SOT-23	DBV	5	3000	180.0	8.4	3.2	3.2	1.4	4.0	8.0	Q3
TLV9161IDCKR	SC70	DCK	5	3000	178.0	9.0	2.4	2.5	1.2	4.0	8.0	Q3
TLV9161SIDBVR	SOT-23	DBV	6	3000	180.0	8.4	3.2	3.2	1.4	4.0	8.0	Q3
TLV9162IDDFR	SOT-23-THIN	DDF	8	3000	180.0	8.4	3.2	3.2	1.4	4.0	8.0	Q3
TLV9162IDGKR	VSSOP	DGK	8	2500	330.0	12.4	5.25	3.35	1.25	8.0	12.0	Q1
TLV9162IDR	SOIC	D	8	3000	330.0	12.4	6.4	5.2	2.1	8.0	12.0	Q1
TLV9162IDSGR	WSON	DSG	8	3000	180.0	8.4	2.3	2.3	1.15	4.0	8.0	Q2
TLV9162IPWR	TSSOP	PW	8	3000	330.0	12.4	7.0	3.6	1.6	8.0	12.0	Q1
TLV9162SIRUGR	X2QFN	RUG	10	3000	180.0	8.4	1.75	2.25	0.55	4.0	8.0	Q1
TLV9164IDR	SOIC	D	14	3000	330.0	16.4	6.5	9.0	2.1	8.0	16.0	Q1
TLV9164IPWR	TSSOP	PW	14	3000	330.0	12.4	6.9	5.6	1.6	8.0	12.0	Q1

TAPE AND REEL BOX DIMENSIONS

*All dimensions are nominal

Device	Package Type	Package Drawing	Pins	SPQ	Length (mm)	Width (mm)	Height (mm)
TLV9161IDBVR	SOT-23	DBV	5	3000	210.0	185.0	35.0
TLV9161IDCKR	SC70	DCK	5	3000	180.0	180.0	18.0
TLV9161SIDBVR	SOT-23	DBV	6	3000	210.0	185.0	35.0
TLV9162IDDFR	SOT-23-THIN	DDF	8	3000	210.0	185.0	35.0
TLV9162IDGKR	VSSOP	DGK	8	2500	366.0	364.0	50.0
TLV9162IDR	SOIC	D	8	3000	353.0	353.0	32.0
TLV9162IDSGR	WSON	DSG	8	3000	210.0	185.0	35.0
TLV9162IPWR	TSSOP	PW	8	3000	353.0	353.0	32.0
TLV9162SIRUGR	X2QFN	RUG	10	3000	210.0	185.0	35.0
TLV9164IDR	SOIC	D	14	3000	353.0	353.0	32.0
TLV9164IPWR	TSSOP	PW	14	3000	356.0	356.0	35.0



D0014A

PACKAGE OUTLINE

SOIC - 1.75 mm max height

SMALL OUTLINE INTEGRATED CIRCUIT



4220718/A 09/2016

NOTES:

1. All linear dimensions are in millimeters. Dimensions in parenthesis are for reference only. Dimensioning and tolerancing per ASME Y14.5M.
2. This drawing is subject to change without notice.
3. This dimension does not include mold flash, protrusions, or gate burrs. Mold flash, protrusions, or gate burrs shall not exceed 0.15 mm, per side.
4. This dimension does not include interlead flash. Interlead flash shall not exceed 0.43 mm, per side.
5. Reference JEDEC registration MS-012, variation AB.

EXAMPLE BOARD LAYOUT

D0014A

SOIC - 1.75 mm max height

SMALL OUTLINE INTEGRATED CIRCUIT



LAND PATTERN EXAMPLE
SCALE:8X



SOLDER MASK DETAILS

4220718/A 09/2016

NOTES: (continued)

- 6. Publication IPC-7351 may have alternate designs.
- 7. Solder mask tolerances between and around signal pads can vary based on board fabrication site.

EXAMPLE STENCIL DESIGN

D0014A

SOIC - 1.75 mm max height

SMALL OUTLINE INTEGRATED CIRCUIT



SOLDER PASTE EXAMPLE
BASED ON 0.125 mm THICK STENCIL
SCALE:8X

4220718/A 09/2016

NOTES: (continued)

8. Laser cutting apertures with trapezoidal walls and rounded corners may offer better paste release. IPC-7525 may have alternate design recommendations.
9. Board assembly site may have different recommendations for stencil design.

GENERIC PACKAGE VIEW

RUG 10

X2QFN - 0.4 mm max height

1.5 x 2, 0.5 mm pitch

PLASTIC QUAD FLATPACK - NO LEAD

This image is a representation of the package family, actual package may vary.
Refer to the product data sheet for package details.



4231768/A

EXAMPLE BOARD LAYOUT

RUG0010A

X2QFN - 0.4 mm max height

PLASTIC QUAD FLATPACK - NO LEAD

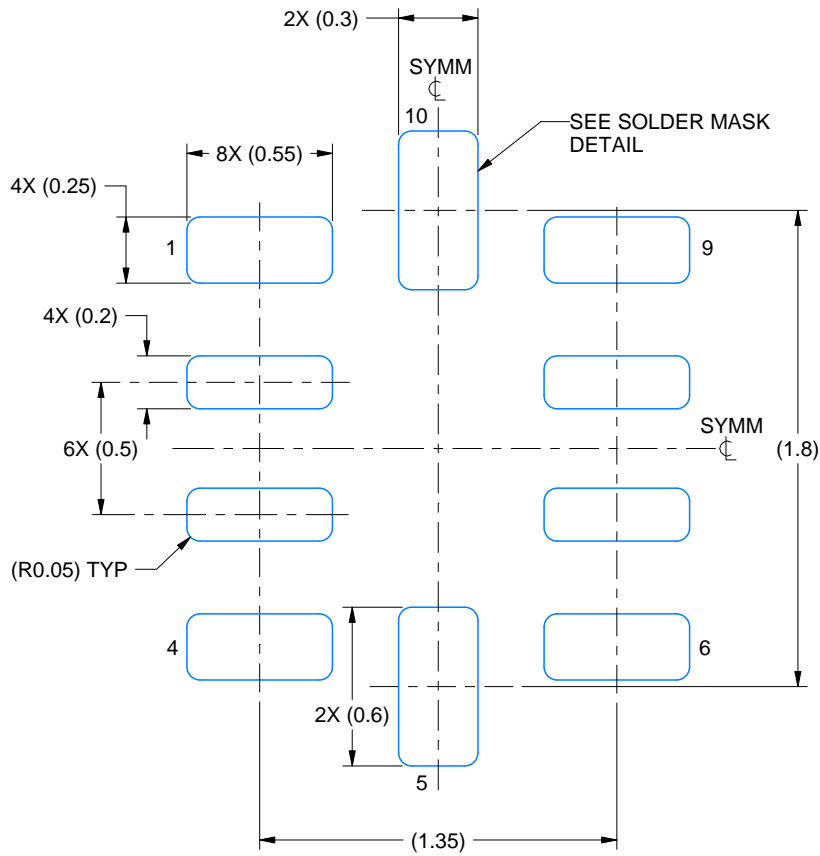

LAND PATTERN EXAMPLE
EXPOSED METAL SHOWN
SCALE: 35X

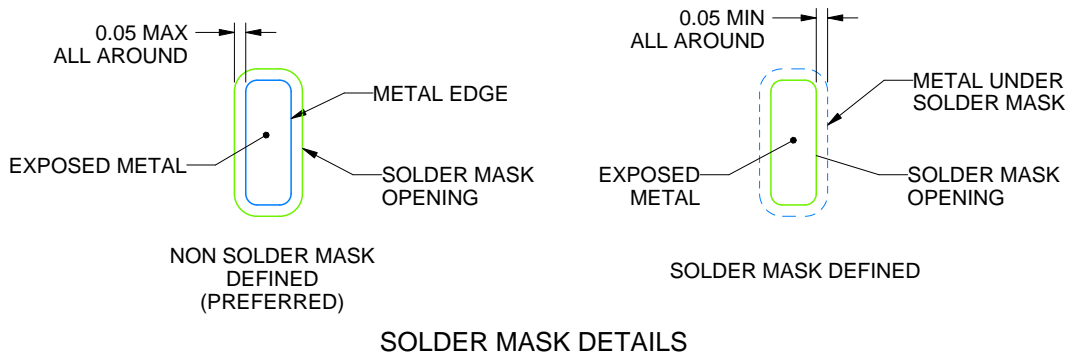

4231745/B 03/2026

NOTES: (continued)

3. For more information, see Texas Instruments literature number SLUA271 (www.ti.com/lit/sluea271).

DCK0005A



PACKAGE OUTLINE

SOT - 1.1 max height

SMALL OUTLINE TRANSISTOR

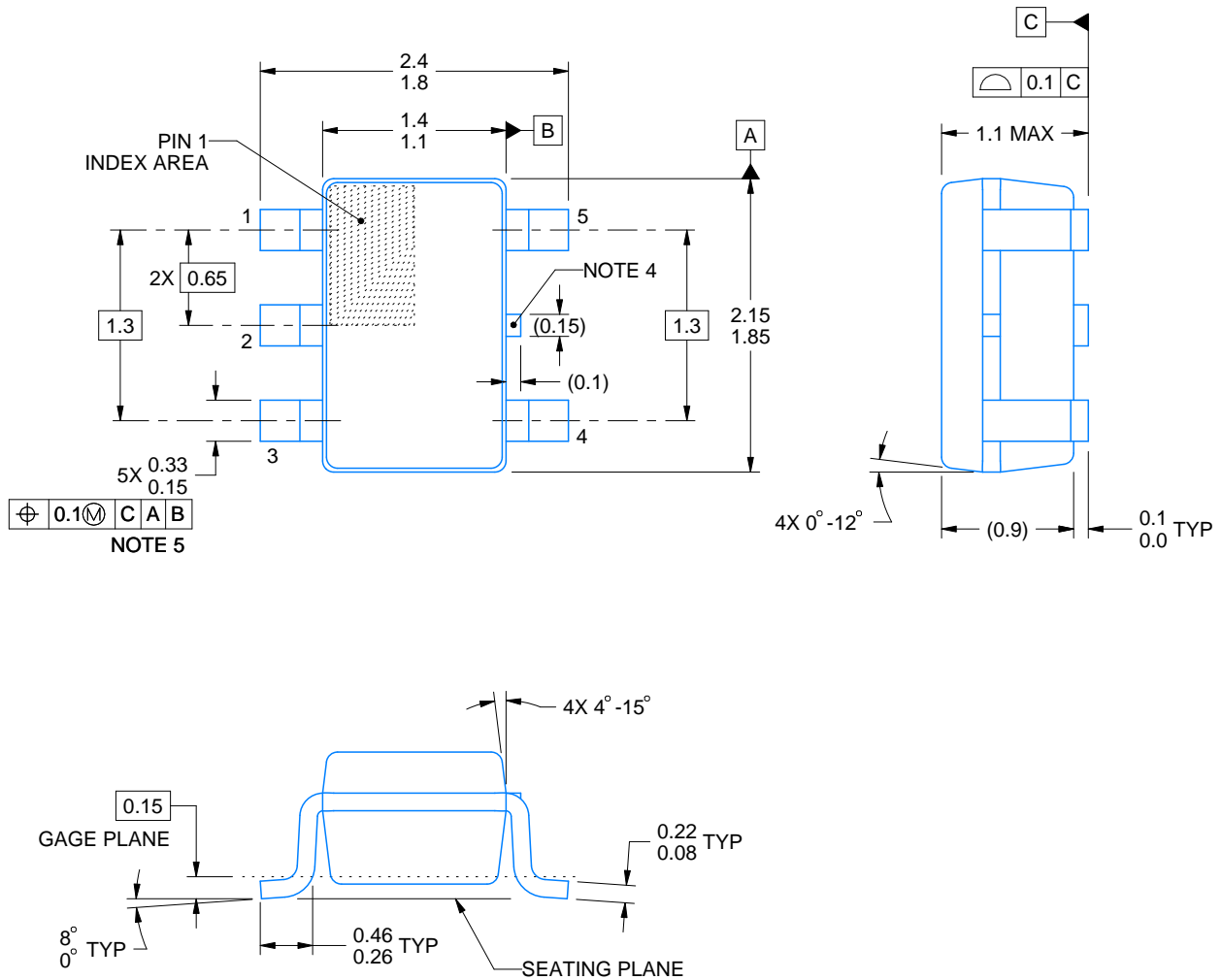

4214834/G 11/2024

NOTES:

1. All linear dimensions are in millimeters. Any dimensions in parenthesis are for reference only. Dimensioning and tolerancing per ASME Y14.5M.
2. This drawing is subject to change without notice.
3. Reference JEDEC MO-203.
4. Support pin may differ or may not be present.
5. Lead width does not comply with JEDEC.
6. Body dimensions do not include mold flash, protrusions, or gate burrs. Mold flash, protrusions, or gate burrs shall not exceed 0.25mm per side

EXAMPLE BOARD LAYOUT

DCK0005A

SOT - 1.1 max height

SMALL OUTLINE TRANSISTOR



LAND PATTERN EXAMPLE
EXPOSED METAL SHOWN
SCALE:18X



SOLDER MASK DETAILS

4214834/G 11/2024

NOTES: (continued)

- 7. Publication IPC-7351 may have alternate designs.
- 8. Solder mask tolerances between and around signal pads can vary based on board fabrication site.

EXAMPLE STENCIL DESIGN

DCK0005A

SOT - 1.1 max height

SMALL OUTLINE TRANSISTOR



SOLDER PASTE EXAMPLE
BASED ON 0.125 THICK STENCIL
SCALE: 18X

4214834/G 11/2024

NOTES: (continued)

9. Laser cutting apertures with trapezoidal walls and rounded corners may offer better paste release. IPC-7525 may have alternate design recommendations.
10. Board assembly site may have different recommendations for stencil design.

DDF0008A



PACKAGE OUTLINE

SOT-23-THIN - 1.1 mm max height

PLASTIC SMALL OUTLINE



4222047/E 07/2024

NOTES:

1. All linear dimensions are in millimeters. Any dimensions in parenthesis are for reference only. Dimensioning and tolerancing per ASME Y14.5M.
2. This drawing is subject to change without notice.
3. This dimension does not include mold flash, protrusions, or gate burrs. Mold flash, protrusions, or gate burrs shall not exceed 0.15 mm per side.

EXAMPLE BOARD LAYOUT

DDF0008A

SOT-23-THIN - 1.1 mm max height

PLASTIC SMALL OUTLINE



LAND PATTERN EXAMPLE
EXPOSED METAL SHOWN
SCALE:15X



SOLDER MASK DETAILS

4222047/E 07/2024

NOTES: (continued)

- 4. Publication IPC-7351 may have alternate designs.
- 5. Solder mask tolerances between and around signal pads can vary based on board fabrication site.

EXAMPLE STENCIL DESIGN

DDF0008A

SOT-23-THIN - 1.1 mm max height

PLASTIC SMALL OUTLINE



SOLDER PASTE EXAMPLE
BASED ON 0.125 mm THICK STENCIL
SCALE:15X

4222047/E 07/2024

NOTES: (continued)

6. Laser cutting apertures with trapezoidal walls and rounded corners may offer better paste release. IPC-7525 may have alternate design recommendations.
7. Board assembly site may have different recommendations for stencil design.



D0008A

PACKAGE OUTLINE

SOIC - 1.75 mm max height

SMALL OUTLINE INTEGRATED CIRCUIT



4214825/C 02/2019

NOTES:

- Linear dimensions are in inches [millimeters]. Dimensions in parenthesis are for reference only. Controlling dimensions are in inches. Dimensioning and tolerancing per ASME Y14.5M.
- This drawing is subject to change without notice.
- This dimension does not include mold flash, protrusions, or gate burrs. Mold flash, protrusions, or gate burrs shall not exceed .006 [0.15] per side.
- This dimension does not include interlead flash.
- Reference JEDEC registration MS-012, variation AA.

EXAMPLE BOARD LAYOUT

D0008A

SOIC - 1.75 mm max height

SMALL OUTLINE INTEGRATED CIRCUIT



LAND PATTERN EXAMPLE
EXPOSED METAL SHOWN
SCALE:8X



SOLDER MASK DETAILS

4214825/C 02/2019

NOTES: (continued)

6. Publication IPC-7351 may have alternate designs.

7. Solder mask tolerances between and around signal pads can vary based on board fabrication site.

EXAMPLE STENCIL DESIGN

D0008A

SOIC - 1.75 mm max height

SMALL OUTLINE INTEGRATED CIRCUIT



SOLDER PASTE EXAMPLE
BASED ON .005 INCH [0.125 MM] THICK STENCIL
SCALE:8X

4214825/C 02/2019

NOTES: (continued)

8. Laser cutting apertures with trapezoidal walls and rounded corners may offer better paste release. IPC-7525 may have alternate design recommendations.
9. Board assembly site may have different recommendations for stencil design.

EXAMPLE BOARD LAYOUT

DBV0006A

SOT-23 - 1.45 mm max height

SMALL OUTLINE TRANSISTOR



LAND PATTERN EXAMPLE
EXPOSED METAL SHOWN
SCALE:15X

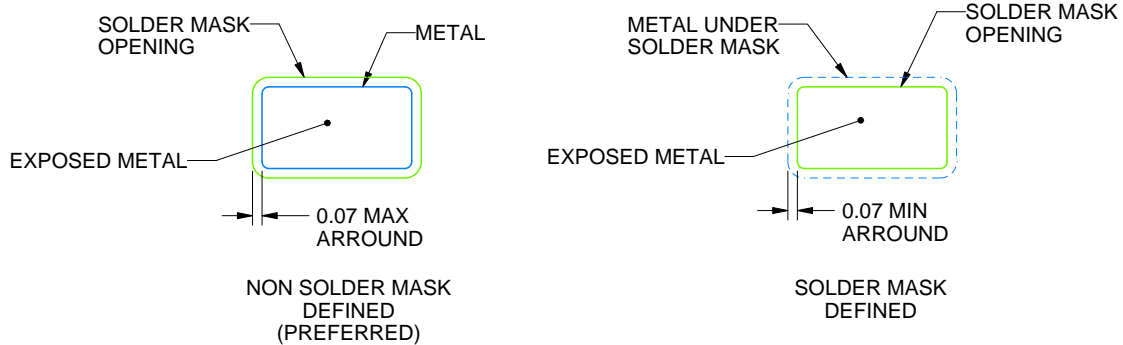

SOLDER MASK DETAILS

4214840/G 08/2024

NOTES: (continued)

6. Publication IPC-7351 may have alternate designs.

7. Solder mask tolerances between and around signal pads can vary based on board fabrication site.

EXAMPLE STENCIL DESIGN

DBV0006A

SOT-23 - 1.45 mm max height

SMALL OUTLINE TRANSISTOR



SOLDER PASTE EXAMPLE
BASED ON 0.125 mm THICK STENCIL
SCALE:15X

4214840/G 08/2024

NOTES: (continued)

8. Laser cutting apertures with trapezoidal walls and rounded corners may offer better paste release. IPC-7525 may have alternate design recommendations.
9. Board assembly site may have different recommendations for stencil design.

GENERIC PACKAGE VIEW

DSG 8

WSON - 0.8 mm max height

2 x 2, 0.5 mm pitch

PLASTIC SMALL OUTLINE - NO LEAD

This image is a representation of the package family, actual package may vary.
Refer to the product data sheet for package details.



4224783/A

DSG0008A



PACKAGE OUTLINE

WSON - 0.8 mm max height

PLASTIC SMALL OUTLINE - NO LEAD

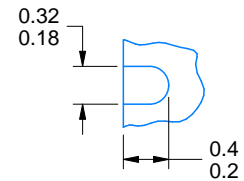
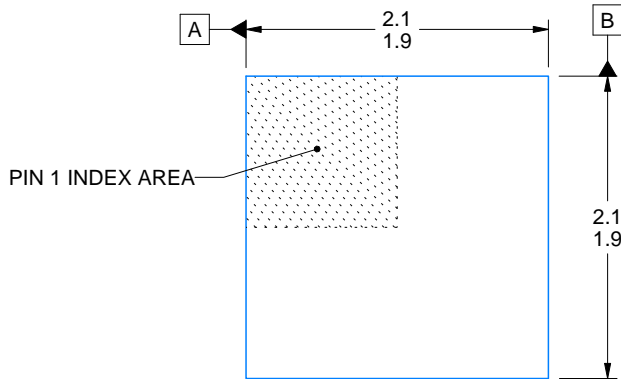

ALTERNATIVE TERMINAL SHAPE TYPICAL

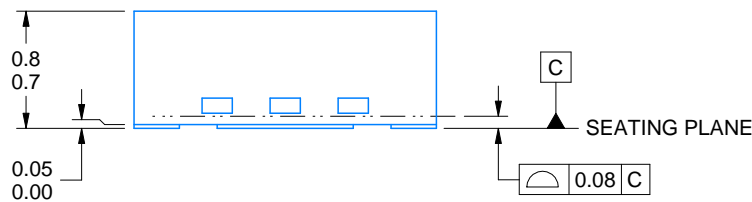

SIDE WALL METAL THICKNESS DIM A	
OPTION 1	OPTION 2
0.1	0.2

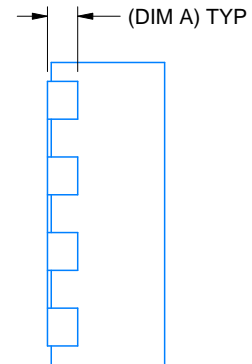
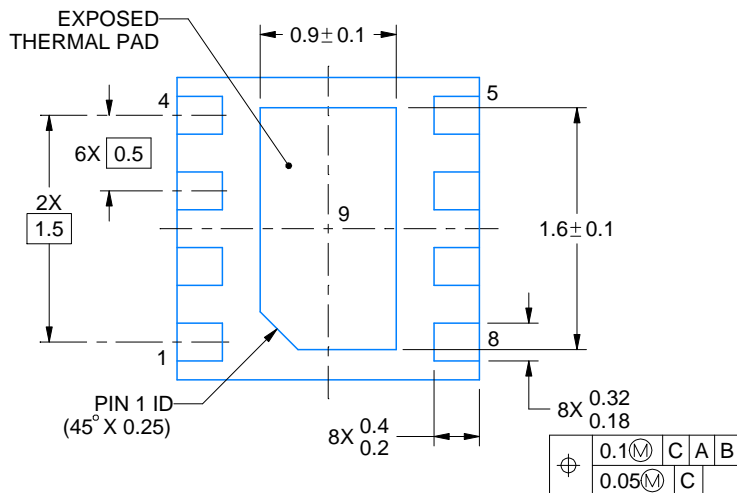

4218900/E 08/2022

NOTES:

1. All linear dimensions are in millimeters. Any dimensions in parenthesis are for reference only. Dimensioning and tolerancing per ASME Y14.5M.
2. This drawing is subject to change without notice.
3. The package thermal pad must be soldered to the printed circuit board for thermal and mechanical performance.

EXAMPLE BOARD LAYOUT

DSG0008A

WSON - 0.8 mm max height

PLASTIC SMALL OUTLINE - NO LEAD

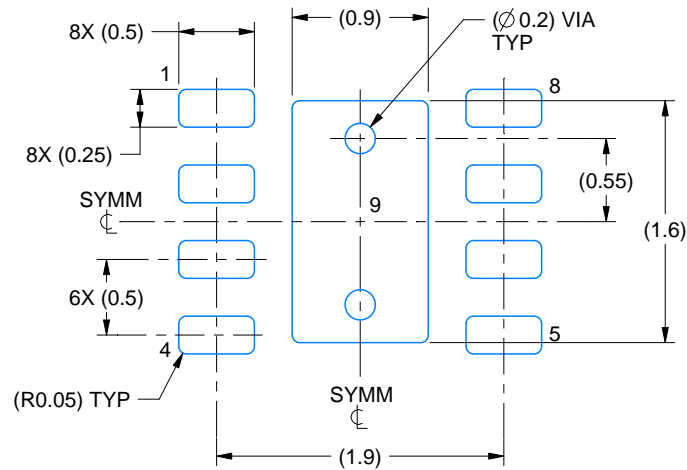

LAND PATTERN EXAMPLE
SCALE:20X

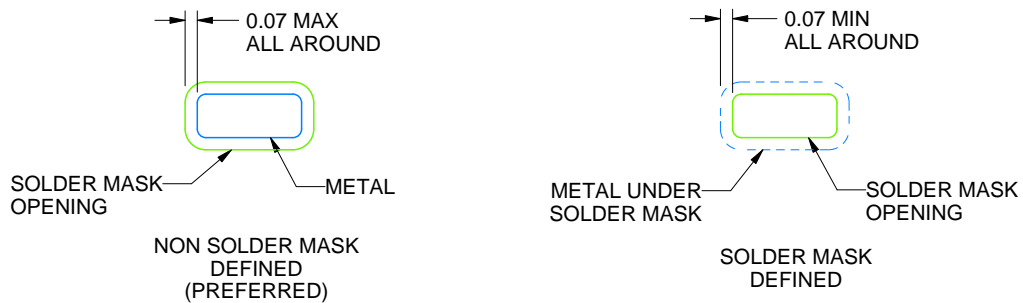

SOLDER MASK DETAILS

4218900/E 08/2022

NOTES: (continued)

4. This package is designed to be soldered to a thermal pad on the board. For more information, see Texas Instruments literature number SLUA271 (www.ti.com/lit/slua271).
5. Vias are optional depending on application, refer to device data sheet. If any vias are implemented, refer to their locations shown on this view. It is recommended that vias under paste be filled, plugged or tented.

EXAMPLE STENCIL DESIGN

DSG0008A

WSON - 0.8 mm max height

PLASTIC SMALL OUTLINE - NO LEAD

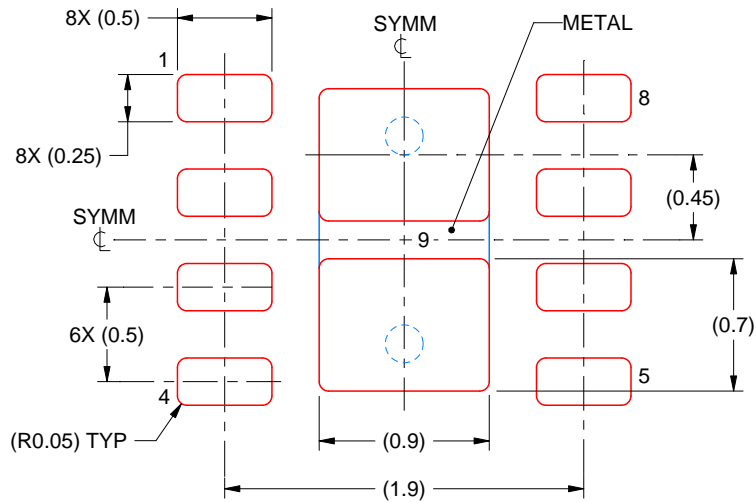

SOLDER PASTE EXAMPLE
BASED ON 0.125 mm THICK STENCIL

EXPOSED PAD 9:
87% PRINTED SOLDER COVERAGE BY AREA UNDER PACKAGE
SCALE:25X

4218900/E 08/2022

NOTES: (continued)

6. Laser cutting apertures with trapezoidal walls and rounded corners may offer better paste release. IPC-7525 may have alternate design recommendations.

PW0014A

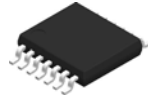

PACKAGE OUTLINE
TSSOP - 1.2 mm max height

SMALL OUTLINE PACKAGE

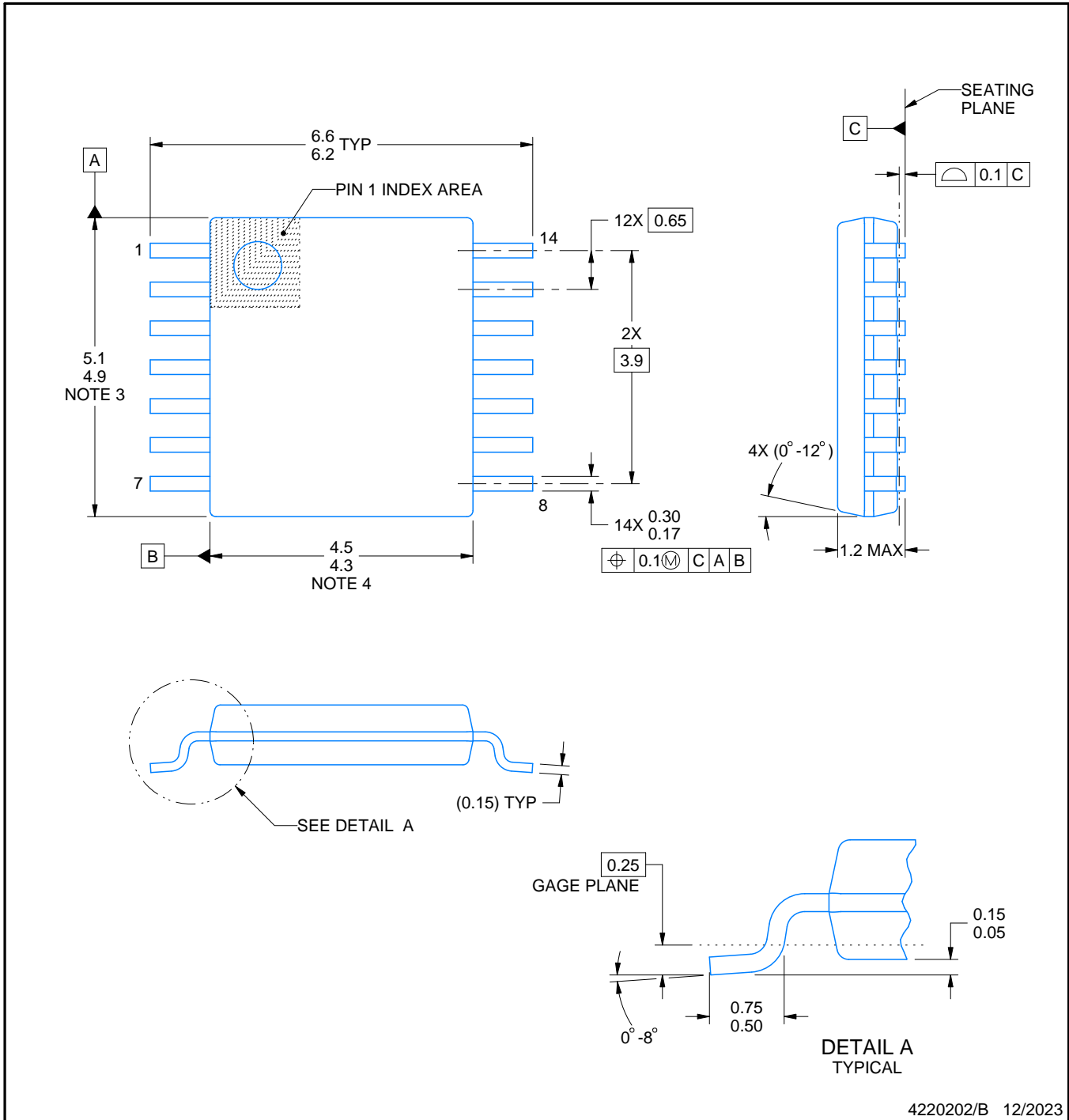

4220202/B 12/2023

NOTES:

1. All linear dimensions are in millimeters. Any dimensions in parenthesis are for reference only. Dimensioning and tolerancing per ASME Y14.5M.
2. This drawing is subject to change without notice.
3. This dimension does not include mold flash, protrusions, or gate burrs. Mold flash, protrusions, or gate burrs shall not exceed 0.15 mm per side.
4. This dimension does not include interlead flash. Interlead flash shall not exceed 0.25 mm per side.
5. Reference JEDEC registration MO-153.

EXAMPLE BOARD LAYOUT

PW0014A

TSSOP - 1.2 mm max height

SMALL OUTLINE PACKAGE

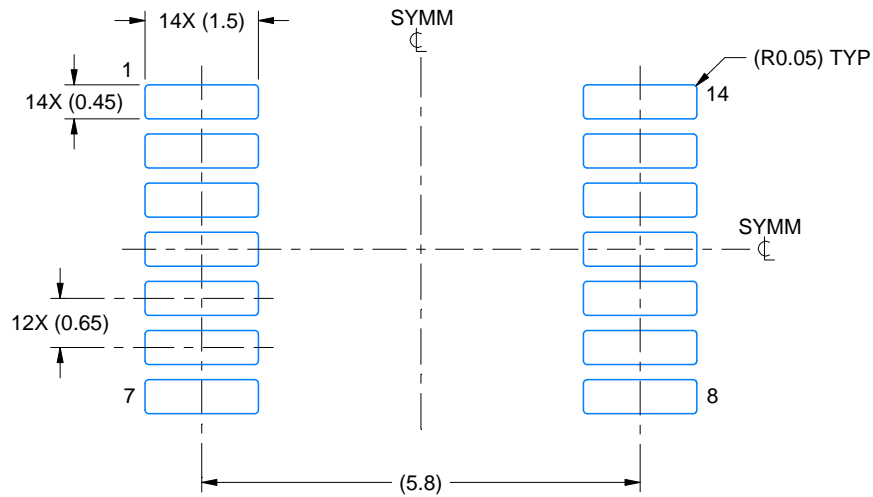

LAND PATTERN EXAMPLE
EXPOSED METAL SHOWN
SCALE: 10X



4220202/B 12/2023

NOTES: (continued)

- 6. Publication IPC-7351 may have alternate designs.
- 7. Solder mask tolerances between and around signal pads can vary based on board fabrication site.

EXAMPLE STENCIL DESIGN

PW0014A

TSSOP - 1.2 mm max height

SMALL OUTLINE PACKAGE



SOLDER PASTE EXAMPLE
BASED ON 0.125 mm THICK STENCIL
SCALE: 10X

4220202/B 12/2023

NOTES: (continued)

8. Laser cutting apertures with trapezoidal walls and rounded corners may offer better paste release. IPC-7525 may have alternate design recommendations.
9. Board assembly site may have different recommendations for stencil design.

EXAMPLE BOARD LAYOUT

PW0008A

TSSOP - 1.2 mm max height

SMALL OUTLINE PACKAGE



LAND PATTERN EXAMPLE
SCALE:10X



SOLDER MASK DETAILS
NOT TO SCALE

4221848/A 02/2015

NOTES: (continued)

- 6. Publication IPC-7351 may have alternate designs.
- 7. Solder mask tolerances between and around signal pads can vary based on board fabrication site.

EXAMPLE STENCIL DESIGN

PW0008A

TSSOP - 1.2 mm max height

SMALL OUTLINE PACKAGE



SOLDER PASTE EXAMPLE
BASED ON 0.125 mm THICK STENCIL
SCALE:10X

4221848/A 02/2015

NOTES: (continued)

8. Laser cutting apertures with trapezoidal walls and rounded corners may offer better paste release. IPC-7525 may have alternate design recommendations.
9. Board assembly site may have different recommendations for stencil design.

EXAMPLE BOARD LAYOUT

DBV0005A

SOT-23 - 1.45 mm max height

SMALL OUTLINE TRANSISTOR



LAND PATTERN EXAMPLE
EXPOSED METAL SHOWN
SCALE:15X



SOLDER MASK DETAILS

4214839/K 08/2024

NOTES: (continued)

- 6. Publication IPC-7351 may have alternate designs.
- 7. Solder mask tolerances between and around signal pads can vary based on board fabrication site.

EXAMPLE STENCIL DESIGN

DBV0005A

SOT-23 - 1.45 mm max height

SMALL OUTLINE TRANSISTOR



SOLDER PASTE EXAMPLE
BASED ON 0.125 mm THICK STENCIL
SCALE:15X

4214839/K 08/2024

NOTES: (continued)

8. Laser cutting apertures with trapezoidal walls and rounded corners may offer better paste release. IPC-7525 may have alternate design recommendations.
9. Board assembly site may have different recommendations for stencil design.

DGK0008A

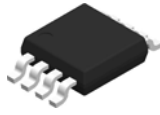

PACKAGE OUTLINE

VSSOP - 1.1 mm max height

SMALL OUTLINE PACKAGE



4214862/A 04/2023

NOTES:

PowerPAD is a trademark of Texas Instruments.

1. All linear dimensions are in millimeters. Any dimensions in parenthesis are for reference only. Dimensioning and tolerancing per ASME Y14.5M.
2. This drawing is subject to change without notice.
3. This dimension does not include mold flash, protrusions, or gate burrs. Mold flash, protrusions, or gate burrs shall not exceed 0.15 mm per side.
4. This dimension does not include interlead flash. Interlead flash shall not exceed 0.25 mm per side.
5. Reference JEDEC registration MO-187.

EXAMPLE BOARD LAYOUT

DGK0008A

™ VSSOP - 1.1 mm max height

SMALL OUTLINE PACKAGE

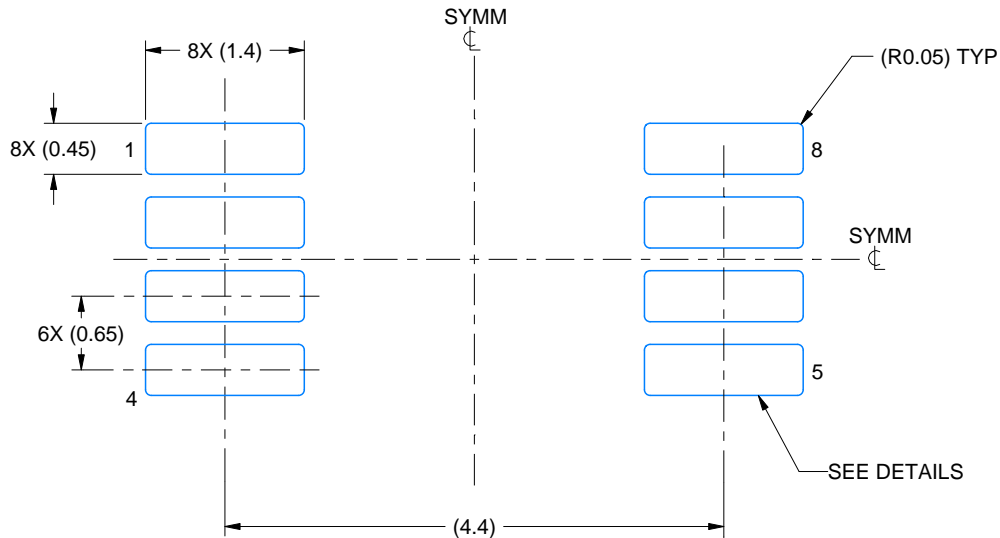

LAND PATTERN EXAMPLE
EXPOSED METAL SHOWN
SCALE: 15X

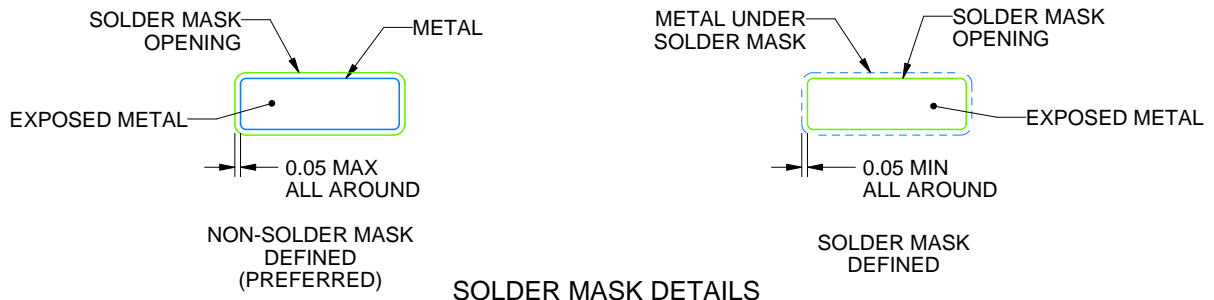

SOLDER MASK DETAILS

4214862/A 04/2023

NOTES: (continued)

6. Publication IPC-7351 may have alternate designs.
7. Solder mask tolerances between and around signal pads can vary based on board fabrication site.
8. Vias are optional depending on application, refer to device data sheet. If any vias are implemented, refer to their locations shown on this view. It is recommended that vias under paste be filled, plugged or tented.
9. Size of metal pad may vary due to creepage requirement.

EXAMPLE STENCIL DESIGN

DGK0008A

TM VSSOP - 1.1 mm max height

SMALL OUTLINE PACKAGE



SOLDER PASTE EXAMPLE
SCALE: 15X

4214862/A 04/2023

NOTES: (continued)

11. Laser cutting apertures with trapezoidal walls and rounded corners may offer better paste release. IPC-7525 may have alternate design recommendations.
12. Board assembly site may have different recommendations for stencil design.

IMPORTANT NOTICE AND DISCLAIMER

TI PROVIDES TECHNICAL AND RELIABILITY DATA (INCLUDING DATASHEETS), DESIGN RESOURCES (INCLUDING REFERENCE DESIGNS), APPLICATION OR OTHER DESIGN ADVICE, WEB TOOLS, SAFETY INFORMATION, AND OTHER RESOURCES "AS IS" AND WITH ALL FAULTS, AND DISCLAIMS ALL WARRANTIES, EXPRESS AND IMPLIED, INCLUDING WITHOUT LIMITATION ANY IMPLIED WARRANTIES OF MERCHANTABILITY, FITNESS FOR A PARTICULAR PURPOSE OR NON-INFRINGEMENT OF THIRD PARTY INTELLECTUAL PROPERTY RIGHTS.

These resources are intended for skilled developers designing with TI products. You are solely responsible for (1) selecting the appropriate TI products for your application, (2) designing, validating and testing your application, and (3) ensuring your application meets applicable standards, and any other safety, security, regulatory or other requirements.

These resources are subject to change without notice. TI grants you permission to use these resources only for development of an application that uses the TI products described in the resource. Other reproduction and display of these resources is prohibited. No license is granted to any other TI intellectual property right or to any third party intellectual property right. TI disclaims responsibility for, and you fully indemnify TI and its representatives against any claims, damages, costs, losses, and liabilities arising out of your use of these resources.

TI's products are provided subject to [TI's Terms of Sale](#), [TI's General Quality Guidelines](#), or other applicable terms available either on ti.com or provided in conjunction with such TI products. TI's provision of these resources does not expand or otherwise alter TI's applicable warranties or warranty disclaimers for TI products. Unless TI explicitly designates a product as custom or customer-specified, TI products are standard, catalog, general purpose devices.

TI objects to and rejects any additional or different terms you may propose.

Copyright © 2026, Texas Instruments Incorporated

Last updated 10/2025