

# TMAG5253 Low-Power Linear Hall Effect Sensor With EN Pin in Ultra-Small Package

## 1 Features

- Industry-leading low power:
  - Supply voltage,  $V_{CC}$ : 1.65V – 3.6V
  - Shutdown current: < 20nA (1.8V at 25°C)
  - Active current: 2mA (1.8V at 25°C)
  - Average current: < 10µA at 100Hz duty cycling
- Dedicated enable pin
- Fast power-on time
  - Bipolar: < 25µs (typ)
  - Unipolar : < 60µs (typ)
- Ratiometric analog output proportional to  $V_{CC}$
- High impedance output during shutdown mode
- Low-noise output with  $\pm 1$ mA drive
- Two sensitivity polarity options
  - TMAG5253Bx: Bipolar device option
  - TMAG5253Ux: Unipolar device option
- Bipolar Magnetic sensitivity range options:
  - BA1:  $\pm 20$ mT Range
  - BA2:  $\pm 40$ mT Range
  - BA3:  $\pm 80$ mT Range
  - BA4:  $\pm 160$ mT Range
- Unipolar Magnetic sensitivity range options:
  - UA2: 39mT Range
  - UA5: 52mT Range
- Sensitivity compensation to support temperature drift of Neodymium magnet
- Ultra-small X2SON 4-pin package: 1.54mm<sup>2</sup>
- Wide operating temperature range: –40°C to 125°C

## 2 Applications

- [Gaming controller & peripherals](#)
- [Magnetic proximity sensor](#)
- [Mobile robot motor control](#)
- [Cordless power tools](#)
- [Vacuum robots](#)
- [Drone payload control](#)

## 3 Description

The TMAG5253 is a low-power linear Hall effect sensor that responds proportionally to magnetic flux density. The device features an enable pin to enter ultra-low power (nA) shutdown mode. The TMAG5253 features a fast start-up time (< 25µs and < 60µs) designed for low-power position sensing applications. The device is available in an industry-leading 1.54mm<sup>2</sup> ultra-small footprint for space-constrained applications. The device has a wide supply range and can operate from 1.65V to 3.6V.

Magnetic flux perpendicular to the top of the package is sensed by the device and the TMAG5253 is available in two sensitivity polarity options: bipolar and unipolar. North and south magnetic poles produce unique voltages in the bipolar option and the unipolar option is sensitive to either the south or the north magnetic pole. The output changes linearly with the applied magnetic flux density, and four sensitivity (in bipolar) and one sensitivity (in Unipolar) options enable maximal output voltage swing based on the required sensing range.

The device uses a ratiometric architecture that can eliminate error from  $V_{CC}$  tolerance when the external analog-to-digital converter (ADC) uses the same  $V_{CC}$  for the reference. Additionally, the device features magnet temperature compensation to counteract the magnetic sensitivity drifts across a wide –40°C to 125°C temperature range. The device also features the ability to place the output in a high impedance state during shutdown mode. This enables multiple devices to be connected to a single ADC.

### Package Information

PART NUMBER	PACKAGE <sup>(1)</sup>	PACKAGE SIZE <sup>(2)</sup>
TMAG5253	DMR (X2SON, 4)	1.40mm × 1.10mm

- (1) For all available packages, see the orderable addendum at the end of the data sheet.
- (2) The package size (length × width) is a nominal value and includes pins, where applicable.

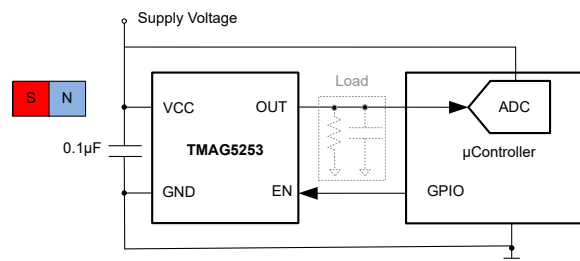

**Typical Schematic**



## Table of Contents

<b>1 Features</b> .....	1	7.3 Sensitivity Temperature Compensation.....	15
<b>2 Applications</b> .....	1	7.4 Quiescent Voltage Temperature Drift.....	16
<b>3 Description</b> .....	1	7.5 Power-On Time.....	16
<b>4 Device Comparison</b> .....	3	<b>8 Detailed Description</b> .....	17
<b>5 Pin Configuration and Functions</b> .....	3	8.1 Overview.....	17
<b>6 Specifications</b> .....	4	8.2 Functional Block Diagram.....	17
6.1 Absolute Maximum Ratings.....	4	8.3 Feature Description.....	17
6.2 ESD Ratings.....	4	8.4 Device Functional Modes.....	19
6.3 Recommended Operating Conditions.....	4	<b>9 Application and Implementation</b> .....	20
6.4 Thermal Information.....	4	9.1 Application Information.....	20
6.5 Electrical Characteristics (Bipolar, TMAG5253BAx).....	5	9.2 Typical Applications.....	23
6.6 Magnetic Characteristics (Bipolar, TMAG5253BAx).....	5	9.3 Best Design Practices.....	28
6.7 Electrical Characteristics (Unipolar, TMAG5253UAx).....	7	9.4 Power Supply Recommendations.....	29
6.8 Magnetic Characteristics (Unipolar, TMAG5253UAx).....	7	9.5 Layout.....	29
6.9 Typical Characteristics (Bipolar, TMAG5253BAx).....	9	<b>10 Device and Documentation Support</b> .....	30
6.10 Typical Characteristics (Unipolar, TMAG5253UAx).....	11	10.1 Documentation Support.....	30
<b>7 Parameter Measurement Information</b> .....	13	10.2 Receiving Notification of Documentation Updates..	30
7.1 Sensitivity Linearity.....	13	10.3 Support Resources.....	30
7.2 Ratiometric Architecture.....	14	10.4 Trademarks.....	30
		10.5 Electrostatic Discharge Caution.....	30
		10.6 Glossary.....	30
		<b>11 Revision History</b> .....	30
		<b>12 Mechanical, Packaging, and Orderable Information</b> .....	31

## 4 Device Comparison

**Table 4-1. Device Comparison**

ORDERABLE	MAGNETIC RESPONSE TYPE	MINIMUM LINEAR MAGNETIC SENSING RANGE (mT)	TYPICAL SENSITIVITY TEMPERATURE COEFFICIENT (%/°C)
TMAG5253BA1	Bipolar (TMAG5253BAx)	±20	0.12
TMAG5253BA2		±40	0.12
TMAG5253BA3		±80	0.12
TMAG5253BA4		±160	0.12
TMAG5253UA1	Unipolar (TMAG5253UAx)	+20	0.12
TMAG5253UA2		+39	0.12
TMAG5253UA3		+80	0.12
TMAG5253UA4		+160	0.12
TMAG5253UA5		+52	0.12

## 5 Pin Configuration and Functions

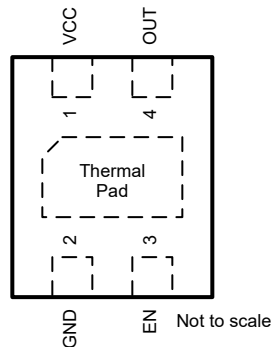

**Figure 5-1. DMR Package 4-Pin X2SON Top View**

**Table 5-1. Pin Functions**

PIN		TYPE <sup>(1)</sup>	DESCRIPTION
NAME	X2SON		
V <sub>CC</sub>	1	P	Power supply. TI recommends connecting this pin to a ceramic capacitor to ground with a value of at least 0.1µF.
GND	2	G	Ground reference
EN	3	I	Enable pin
OUT	4	O	Analog output
Thermal Pad	5	NC	No connect. Leave this pin floating or tied to ground. The pin must be soldered to the board for mechanical support.

(1) I = Input, O = Output, I/O = Input and Output, G = Ground, P = Power, NC = No Connect

## 6 Specifications

### 6.1 Absolute Maximum Ratings

Over operating free-air temperature range (unless otherwise noted)<sup>(1)</sup>

		MIN	MAX	UNIT
Power supply voltage	V <sub>CC</sub>	-0.3	5.5	V
Output voltage	OUT	-0.3	V <sub>CC</sub> + 0.3	V
Magnetic flux density, B <sub>MAX</sub>		Unlimited		T
Operating junction temperature, T <sub>J</sub>		-40	125	°C
Storage temperature, T <sub>stg</sub>		-65	150	°C

- (1) Operation outside the *Absolute Maximum Ratings* may cause permanent device damage. *Absolute Maximum Ratings* do not imply functional operation of the device at these or any other conditions beyond those listed under *Recommended Operating Conditions*. If used outside the *Recommended Operating Conditions* but within the *Absolute Maximum Ratings*, the device may not be fully functional, and this may affect device reliability, functionality, performance, and shorten the device lifetime.

### 6.2 ESD Ratings

			VALUE	UNIT
V <sub>(ESD)</sub>	Electrostatic discharge	Human-body model (HBM), per ANSI/ESDA/JEDEC JS-001 <sup>(1)</sup>	±2000	V
		Charged-device model (CDM), per JEDEC specification ANSI/ESDA/JEDEC JS-002 <sup>(2)</sup>	±750	

- (1) JEDEC document JEP155 states that 500V HBM allows safe manufacturing with a standard ESD control process.  
 (2) JEDEC document JEP157 states that 250V CDM allows safe manufacturing with a standard ESD control process.

### 6.3 Recommended Operating Conditions

Over operating free-air temperature range (unless otherwise noted)

		MIN	MAX	UNIT
V <sub>CC</sub>	Power supply voltage	1.65	3.6	V
C <sub>Load</sub>	Load capacitance on OUT pin		1	nF
I <sub>O</sub>	Output continuous current	-1	1	mA
T <sub>A</sub>	Operating ambient temperature <sup>(1)</sup>	-40	125	°C

- (1) Power dissipation and thermal limits must be observed.

### 6.4 Thermal Information

THERMAL METRIC <sup>(1)</sup>		TMAG5253	UNIT
		DMR(X2SON)	
		4 PINS	
R <sub>θJA</sub>	Junction-to-ambient thermal resistance	157.1	°C/W
R <sub>θJC(top)</sub>	Junction-to-case (top) thermal resistance	110.9	°C/W
R <sub>θJB</sub>	Junction-to-board thermal resistance	105	°C/W
Y <sub>JT</sub>	Junction-to-top characterization parameter	2.4	°C/W
Y <sub>JB</sub>	Junction-to-board characterization parameter	101.9	°C/W
R <sub>θJC(bot)</sub>	Junction-to-board (bottom) thermal resistance	85.7	°C/W

- (1) For more information about traditional and new thermal metrics, see the [Semiconductor and IC Package Thermal Metrics](#) application note.

## 6.5 Electrical Characteristics (Bipolar, TMAG5253BAx)

For  $V_{CC} = 1.65V$  to  $3.6V$ , over operating free-air temperature range (unless otherwise noted)

PARAMETER		TEST CONDITIONS <sup>(1)</sup>		MIN	TYP	MAX	UNIT
$I_{CC\_ACTIVE}$	Operating supply current	$V_{CC} = 1.8V$	BAx, $EN > V_{IH}$		2	3.3	mA
		$V_{CC} = 3.3V$			2.6	5	
$I_{CC\_SHDN}$	Shutdown current	$V_{CC} = 3.3V$	BAx, $EN < V_{IL}$		8		nA
$t_{ON}$	Power-on time <sup>(2)</sup>	$V_{CC} > V_{CC(min)}$ , BAx			20	45	$\mu s$
$V_{CCramp}$	$V_{CC}$ ramp rate	$T_A = 25^\circ C$		0.001		1	V / $\mu s$
$V_{IH}$	Input high voltage for EN pin			$0.65 \times V_{CC}$			V
$V_{IL}$	Input low voltage for EN pin			$0.35 \times V_{CC}$			V
$V_{hys}$	Input hysteresis voltage for EN pin			$0.1 \times V_{CC}$			V
$f_{BW}$	Sensing bandwidth (-3 dB)	$R_{Load} = 100k\Omega$ , $C_{Load} = 10pF$			15		kHz
$R_{OUT}$	DC output resistance	$EN > V_{IH}$			1.27		$\Omega$
		$EN < V_{IL}$			9		M $\Omega$

- (1) B is the applied magnetic flux density.  
(2) [Power-On-Time](#) section for more details

## 6.6 Magnetic Characteristics (Bipolar, TMAG5253BAx)

For  $V_{CC} = 1.65V$  to  $3.6V$ , over operating free-air temperature range (unless otherwise noted)

PARAMETER		TEST CONDITIONS <sup>(1)</sup>		MIN	TYP	MAX	UNIT
$V_Q$	Quiescent voltage (Bipolar, BAx)	$V_{CC} = 3.3V$ , $B = 0mT$ , $T_A = 25^\circ C$	Bipolar, BA1	1.585	1.65	1.715	V
			Bipolar, BA2	1.61	1.65	1.69	
			Bipolar, BA3	1.61	1.65	1.69	
			Bipolar, BA4	1.61	1.65	1.69	
		$V_{CC} = 1.8V$ , $B = 0mT$ , $T_A = 25^\circ C$	Bipolar, BA1	0.845	0.9	0.945	
			Bipolar, BA2	0.850	0.9	0.940	
			Bipolar, BA3	0.850	0.9	0.940	
			Bipolar, BA4	0.870	0.9	0.930	
$V_{Q\Delta T}$	Quiescent voltage temperature drift	$V_{CC} = 3.3V$ , $B = 0mT$	$T_A = 0^\circ C$ to $85^\circ C$ vs $25^\circ C$ , Bipolar, BAx	-30		30	mV
			$T_A = -40^\circ C$ to $125^\circ C$ vs $25^\circ C$ , Bipolar, BAx	-50		50	
		$V_{CC} = 1.8V$ , $B = 0mT$	$T_A = 0^\circ C$ to $85^\circ C$ vs $25^\circ C$ , Bipolar, BAx	-25		25	
			$T_A = -40^\circ C$ to $125^\circ C$ vs $25^\circ C$ , Bipolar, BAx	-35		35	
			$T_A = 0^\circ C$ to $50^\circ C$ vs $25^\circ C$ , Bipolar, BA4 only	-5		5	
$V_{QRE}$	Quiescent voltage ratiometry error <sup>(2)</sup>	Bipolar, BAx			$\pm 0.2$		%
$V_{Q\Delta L}$	Quiescent voltage lifetime drift	High-temperature operating stress for 1000 hours $V_{CC} = 3.3V$			10		mV
S	Sensitivity (Bipolar, BAx)	$V_{CC} = 3.3V$ , $T_A = 25^\circ C$	Bipolar, BA1	51	60	69	mV/mT
			Bipolar, BA2	25.5	30	34.5	
			Bipolar, BA3	12.75	15	17.25	
			Bipolar, BA4	6.37	7.5	8.62	
		$V_{CC} = 1.8V$ , $T_A = 25^\circ C$	Bipolar, BA1	25.5	30	34.5	
			Bipolar, BA2	13.6	16	18.4	
			Bipolar, BA3	6.9	8.12	9.33	
			Bipolar, BA4	3	3.5	4.0	

For  $V_{CC} = 1.65V$  to  $3.6V$ , over operating free-air temperature range (unless otherwise noted)

PARAMETER		TEST CONDITIONS <sup>(1)</sup>		MIN	TYP	MAX	UNIT
$B_L$	Linear magnetic sensing range <sup>(3) (4)</sup>	$V_{CC} = 3.3V$	Bipolar, BA1	$\pm 20$			mT
			Bipolar, BA2	$\pm 40$			
			Bipolar, BA3	$\pm 80$			
			Bipolar, BA4	$\pm 160$			
		$V_{CC} = 1.8V$	Bipolar, BA1	$\pm 20$			
			Bipolar, BA2	$\pm 40$			
			Bipolar, BA3	$\pm 80$			
			Bipolar, BA4	$\pm 160$			
$V_L$	Linear range of output voltage <sup>(4)</sup>	Bipolar, BAx		0.2	$V_{CC} - 0.2$	V	
$S_{TC}$	Sensitivity temperature coefficient <sup>(5)</sup>	Bipolar, BAx	$T_A = -40^\circ C$ to $125^\circ C$ vs $25^\circ C$	0.04	0.12	0.2	%/ $^\circ C$
$S_{LE}$	Sensitivity linearity error <sup>(4)</sup>	$V_{OUT}$ is within $V_L$			$\pm 0.1$	$\pm 0.55$	%
$S_{SE}$	Sensitivity symmetry error <sup>(4)</sup>	$V_{OUT}$ is within $V_L$			$\pm 0.1$		%
$S_{RE}$	Sensitivity ratiometry error <sup>(2)</sup>	$T_A = 25^\circ C$	$V_{CC} = 3V - 3.6V$ , With respect to $V_{CC} = 3.3V$	-3		3	%
			$V_{CC} = 1.65V - 1.9V$ , With respect to $V_{CC} = 1.8V$	-2		2	
$S_{\Delta L}$	Sensitivity lifetime drift	High-temperature operating stress for 1000 hours			0.5		%
$B_{ND}$	Input-referred RMS noise density	$V_{CC} = 3.3V$	$C_{Load} = 100pF$		220		nT/ $\sqrt{Hz}$
		$V_{CC} = 1.8V$			400		
$B_N$	Input-referred peak-to-peak noise	$V_{CC} = 3.3V$	$B_{ND} \times 6.6 \times \sqrt{f_{BW}}$ $C_{Load} = 100pF$		0.17		mT <sub>PP</sub>
		$V_{CC} = 1.8V$			0.35		
$V_N$	Output-referred peak-to-peak noise	$B_N \times S$ $V_{CC} = 3.3V$ $BW = 15kHz$	Bipolar, BA1		9.2		mV <sub>PP</sub>
			Bipolar, BA2		4.6		
			Bipolar, BA3		2.3		
			Bipolar, BA4		1.2		

(1) B is the applied magnetic flux density.

(2) Refer to the [Ratiometric Architecture](#) section

(3)  $B_L$  describes the minimum linear sensing range at  $25^\circ C$  taking into account the maximum  $V_Q$  and Sensitivity tolerances.

(4) Refer to the [Sensitivity Linearity](#) section

(5)  $S_{TC}$  describes the rate the device increases Sensitivity with temperature. For more information, see the [Section 7.3](#).

## 6.7 Electrical Characteristics (Unipolar, TMAG5253UAX)

For  $V_{CC} = 1.65V$  to  $3.6V$ , over operating free-air temperature range (unless otherwise noted). Typical specifications are at  $T_A = 25^\circ C$  and  $V_{CC} = 3.3V$  (unless otherwise noted).

PARAMETER		TEST CONDITIONS <sup>(1)</sup>		MIN	TYP	MAX	UNIT
$I_{CC\_ACTIVE}$	Operating supply current	$V_{CC} = 1.8V$ $EN = V_{CC}$	Unipolar, UA2		2.1	3.3	mA
			Unipolar, UA5		1.9	3.3	
		$V_{CC} = 3.3V$ $EN = V_{CC}$	Unipolar, UA2		2.6	4	
			Unipolar, UA5		2.4	4	
$I_{CC\_SHDN}$	Shutdown current	$EN = GND$	$V_{CC} = 1.8V$ and $3.3V$		8		nA
$t_{ON}$	Power-on time <sup>(2)</sup>	$V_{CC} > V_{CC(min)}$			55	130	$\mu s$
$V_{CCramp}$	$V_{CC}$ ramp rate	$T_A = 25^\circ C$		0.001		1	V / $\mu s$
$V_{IH}$	Input high voltage for EN pin			$0.65 \times V_{CC}$			V
$V_{IL}$	Input low voltage for EN pin					$0.35 \times V_{CC}$	V
$V_{hys}$	Input hysteresis voltage for EN pin	Unipolar, UA2		$0.09 \times V_{CC}$			V
		Unipolar, UA5		$0.1 \times V_{CC}$			
$f_{BW}$	Sensing bandwidth (-3 dB)	$R_{Load} = 100k\Omega$ , $C_{Load} = 10pF$			15		kHz
$R_{OUT}$	DC output resistance	$EN > V_{IH}$			1.27		$\Omega$
		$EN < V_{IL}$			9		M $\Omega$

(1) B is the applied magnetic flux density.

(2) [Power-On-Time](#) section for more details.

## 6.8 Magnetic Characteristics (Unipolar, TMAG5253UAX)

For  $V_{CC} = 1.65V$  to  $3.6V$ , over operating free-air temperature range (unless otherwise noted). Typical specifications are at  $T_A = 25^\circ C$  and  $V_{CC} = 3.3V$  (unless otherwise noted).

PARAMETER		TEST CONDITIONS <sup>(1)</sup>		MIN	TYP	MAX	UNIT
$V_Q$	Quiescent voltage	$V_{CC} = 3.3V$ , $B = 0mT$ , $T_A = 25^\circ C$	Unipolar, UA2	0.11	0.2	0.32	V
			Unipolar, UA5	0.11	0.2	0.32	
		$V_{CC} = 1.8V$ , $B = 0mT$ , $T_A = 25^\circ C$	Unipolar, UA2	0.12	0.2	0.29	
			Unipolar, UA5	0.14	0.2	0.29	
$V_{Q\Delta T}$	Quiescent voltage temperature drift	$V_{CC} = 3.3V$ , $B = 0mT$	$T_A = 0^\circ C$ to $85^\circ C$ vs $25^\circ C$ , Unipolar, UA2	-50		50	mV
			$T_A = -40^\circ C$ to $125^\circ C$ vs $25^\circ C$ , Unipolar, UA2 and UA5	-78		78	
		$V_{CC} = 1.8V$ , $B = 0mT$	$T_A = 0^\circ C$ to $85^\circ C$ vs $25^\circ C$ , Unipolar, UA2	-30		30	
			$T_A = -40^\circ C$ to $125^\circ C$ vs $25^\circ C$ , Unipolar, UA2 and UA5	-78		78	
$V_{Q\Delta L}$	Quiescent voltage lifetime drift	High-temperature operating stress for 1000 hours $V_{CC} = 3.3V$			10		mV
S	Sensitivity	$V_{CC} = 3.3V$ , $T_A = 25^\circ C$	Unipolar, UA2	62	73	84	mV/mT
			Unipolar, UA5	40.8	48	55.2	
		$V_{CC} = 1.8V$ , $T_A = 25^\circ C$	Unipolar, UA2	29	35	41	
			Unipolar, UA5	21.0	24.7	28.4	
$B_L$	Linear magnetic sensing range <sup>(2) (3)</sup>	$V_{CC} = 3.3V$ , $T_A = 25^\circ C$	Unipolar, UA2	39			mT
			Unipolar, UA5	52			
		$V_{CC} = 1.8V$ , $T_A = 25^\circ C$	Unipolar, UA2	39			
			Unipolar, UA5	52			
$V_L$	Linear range of output voltage <sup>(3)</sup>	Unipolar, UAX		$V_Q$		$V_{CC} - 0.2$	V

For  $V_{CC} = 1.65V$  to  $3.6V$ , over operating free-air temperature range (unless otherwise noted). Typical specifications are at  $T_A = 25^\circ C$  and  $V_{CC} = 3.3V$  (unless otherwise noted).

PARAMETER		TEST CONDITIONS <sup>(1)</sup>		MIN	TYP	MAX	UNIT
$S_{TC}$	Sensitivity temperature coefficient <sup>(4)</sup>	Unipolar, UA <sub>x</sub>	$T_A = -40^\circ C$ to $125^\circ C$ vs $25^\circ C$	0.04	0.12	0.2	%/ $^\circ C$
$S_{LE}$	Sensitivity linearity error <sup>(3)</sup>	$V_{OUT}$ is within $V_L$			$\pm 0.1$	$\pm 0.55$	%
$S_{RE}$	Sensitivity ratiometry error <sup>(5)</sup>	$T_A = 25^\circ C$	$V_{CC} = 3V - 3.6V$ , With respect to $V_{CC} = 3.3V$	-3		3	%
			$V_{CC} = 1.65V - 1.9V$ , With respect to $V_{CC} = 1.8V$	-2		2	
$S_{\Delta L}$	Sensitivity lifetime drift	High-temperature operating stress for 1000 hours			0.5		%
$B_{ND}$	Input-referred RMS noise density	$V_{CC} = 3.3V$ $C_{Load} = 100pF$	Unipolar, UA2		150		nT/ $\sqrt{Hz}$
			Unipolar, UA5		220		
		$V_{CC} = 1.8V$ $C_{Load} = 100pF$	Unipolar, UA2		320		
			Unipolar, UA5		400		
$B_N$	Input-referred peak-to-peak noise	$V_{CC} = 3.3V$ $C_{Load} = 100pF$ $BW = 15kHz$ $B_{ND} \times 6.6 \times \sqrt{f_{BW}}$	Unipolar, UA2		0.12		mT <sub>PP</sub>
			Unipolar, UA5		0.17		
		$V_{CC} = 1.8V$ $C_{Load} = 100pF$ $BW = 15kHz$ $B_{ND} \times 6.6 \times \sqrt{f_{BW}}$	Unipolar, UA2		0.26		
			Unipolar, UA5		0.35		
$V_N$	Output-referred peak-to-peak noise	$V_{CC} = 3.3V$ $B_N \times S$	Unipolar, UA2		8.5		mV <sub>PP</sub>
			Unipolar, UA5		9		
		$V_{CC} = 1.8V$ $B_N \times S$	Unipolar, UA2		9		

- (1) B is the applied magnetic flux density.
- (2)  $B_L$  describes the minimum linear sensing range at  $25^\circ C$  taking into account the maximum  $V_Q$  and Sensitivity tolerances.
- (3) Refer to the [Sensitivity Linearity](#) section.
- (4)  $S_{TC}$  describes the rate the device increases Sensitivity with temperature. For more information, see the [Section 7.3](#).
- (5) Refer to the [Ratiometric Architecture](#) section

### 6.9 Typical Characteristics (Bipolar, TMAG5253BAx)

T<sub>A</sub> = 25°C (unless otherwise noted)

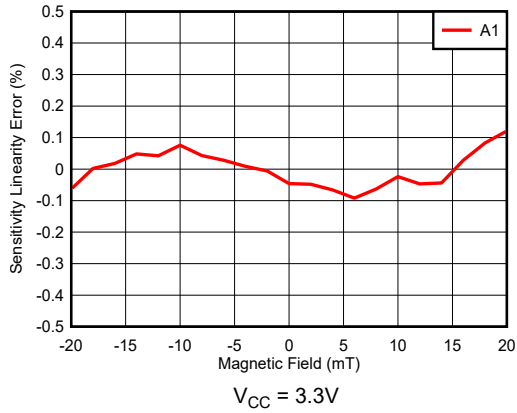

**Figure 6-1. TMAG5253BA1 Sensitivity Linearity Error vs Magnetic Field**

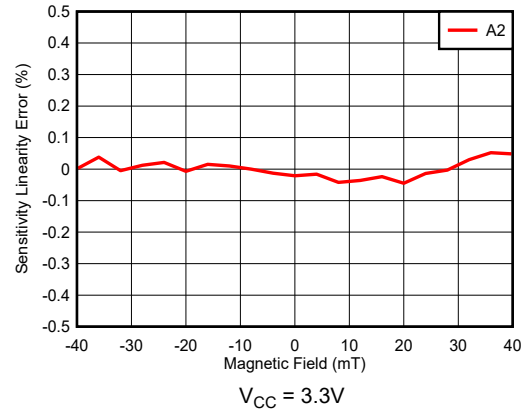

**Figure 6-2. TMAG5253BA2 Sensitivity Linearity Error vs Magnetic Field**

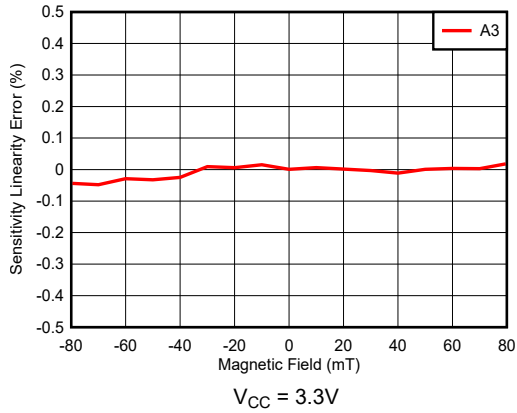

**Figure 6-3. TMAG5253BA3 Sensitivity Linearity Error vs Magnetic Field**

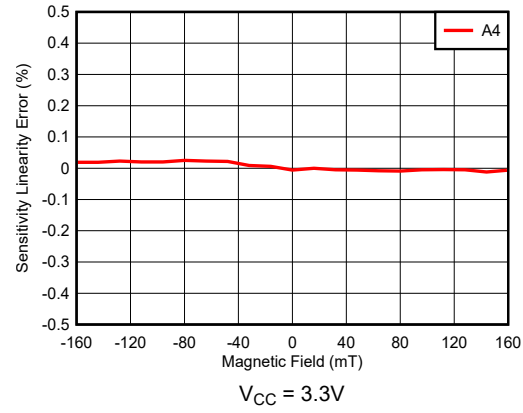

**Figure 6-4. TMAG5253BA4 Sensitivity Linearity Error vs Magnetic Field**

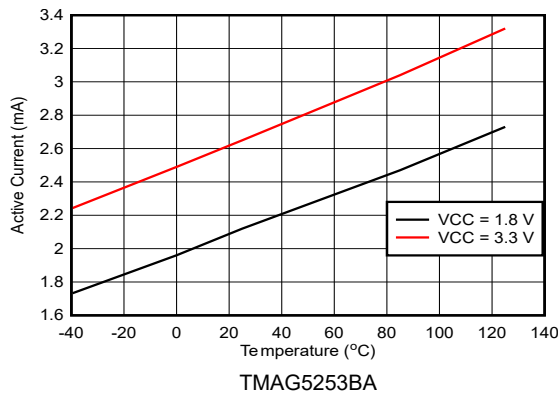

**Figure 6-5. TMAG5253BA Active Current vs Temperature**

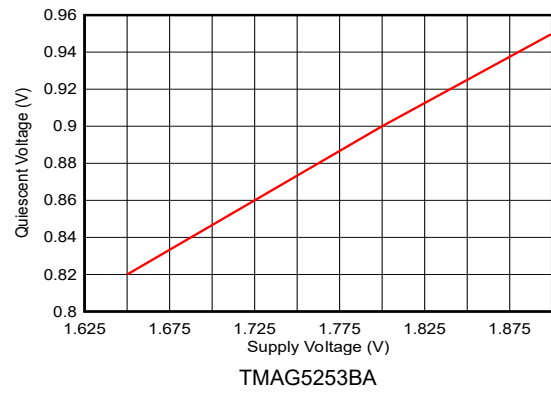

**Figure 6-6. TMAG5253BA Quiescent Voltage vs Supply Voltage**

### 6.9 Typical Characteristics (Bipolar, TMAG5253BAx) (continued)

T<sub>A</sub> = 25°C (unless otherwise noted)

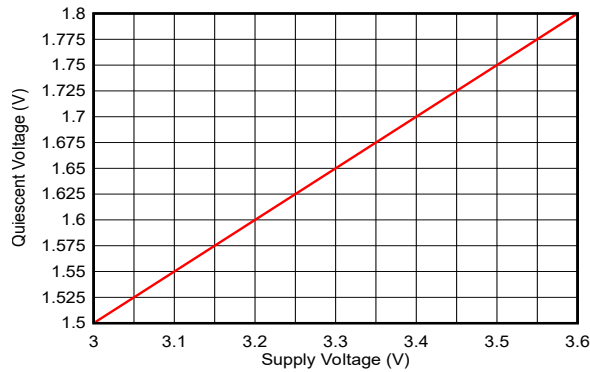

Figure 6-7. TMAG5253BA Quiescent Voltage vs Supply Voltage

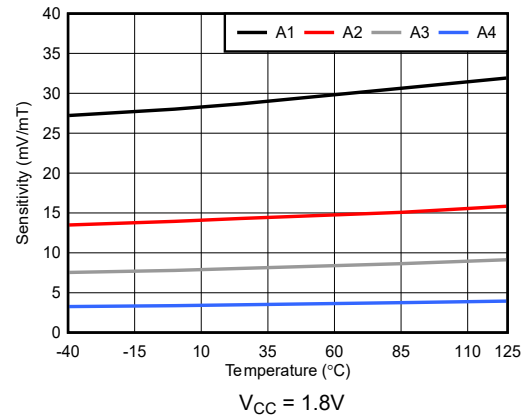

Figure 6-8. TMAG5253BA Sensitivity vs Temperature

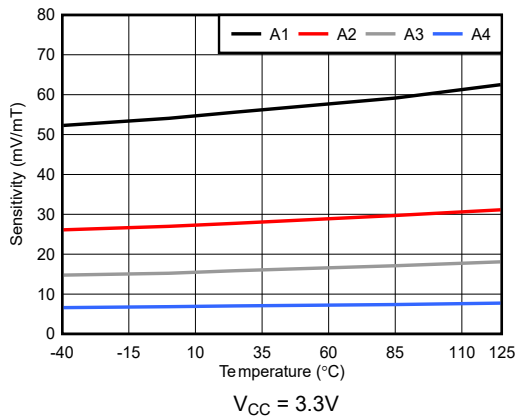

Figure 6-9. TMAG5253BA Sensitivity vs Temperature

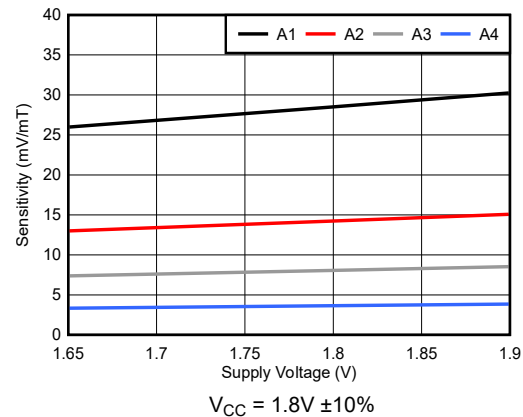

Figure 6-10. TMAG5253BA Sensitivity vs Supply Voltage

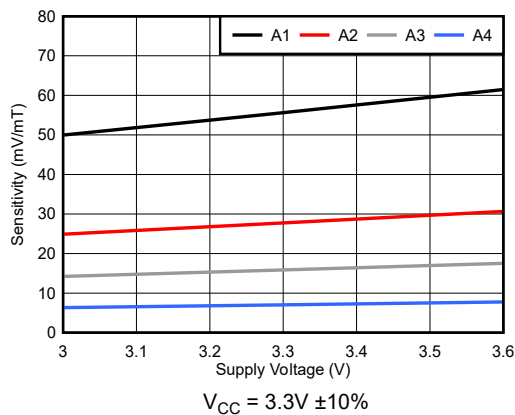

Figure 6-11. TMAG5253BA Sensitivity vs Supply Voltage

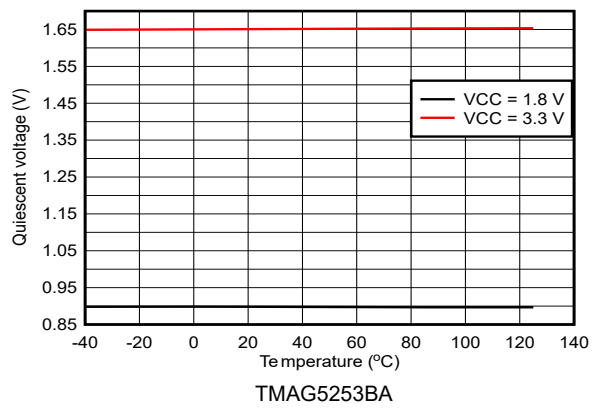
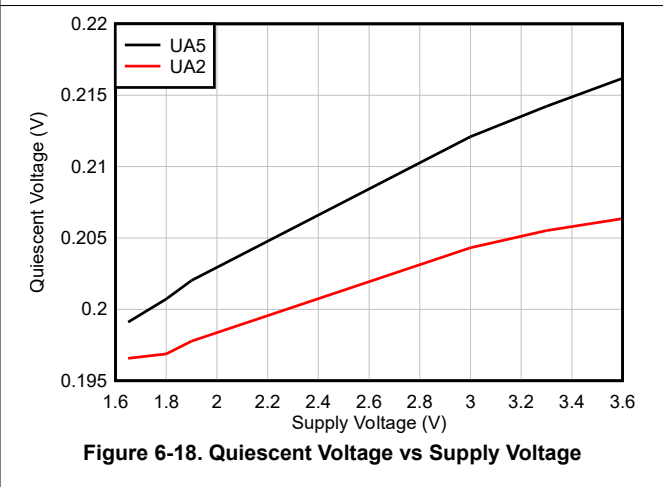
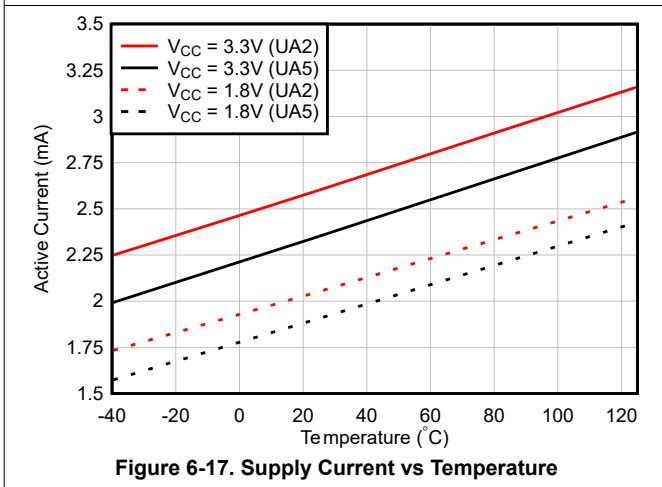
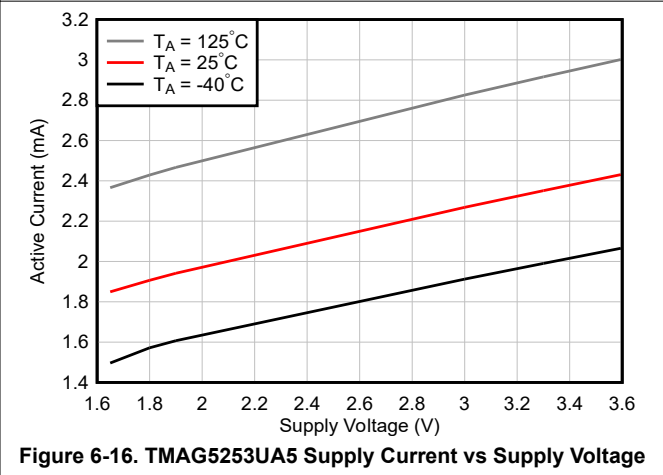
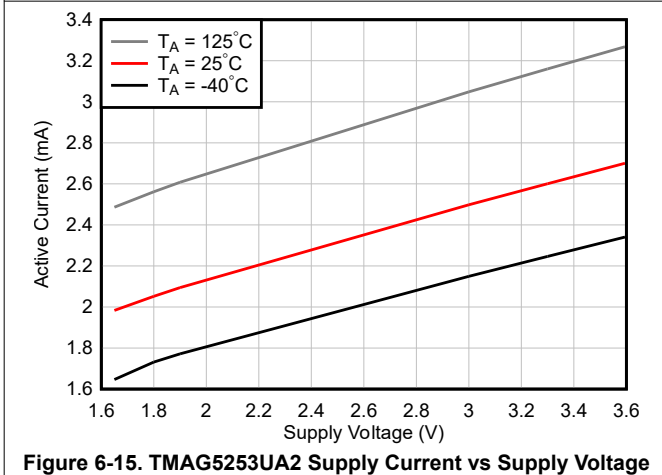
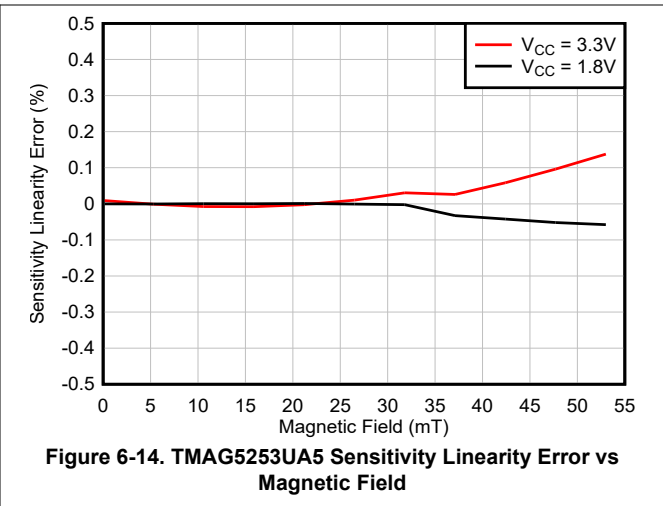
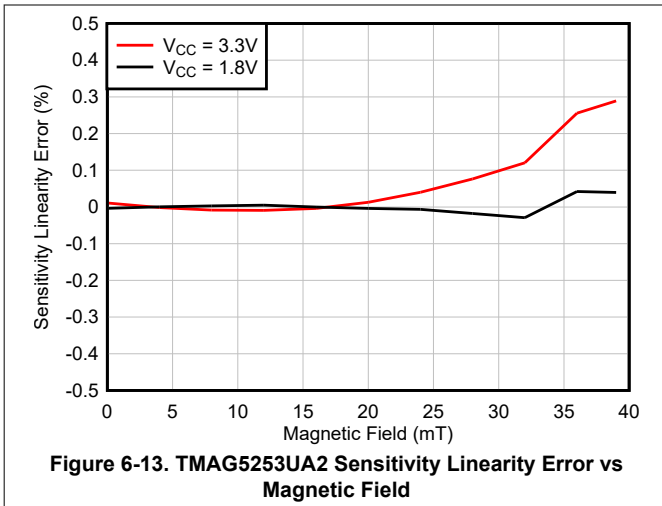

Figure 6-12. TMAG5253BA Quiescent Voltage vs Temperature

### 6.10 Typical Characteristics (Unipolar, TMAG5253UAx)

At  $T_A = 25^\circ\text{C}$  and  $V_{CC} = 3.3\text{V}$  (unless otherwise noted)



### 6.10 Typical Characteristics (Unipolar, TMAG5253UAX) (continued)

At  $T_A = 25^\circ\text{C}$  and  $V_{CC} = 3.3\text{V}$  (unless otherwise noted)

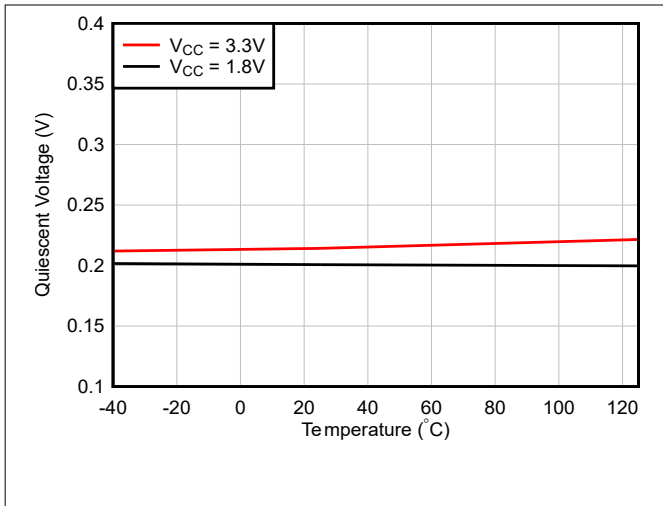

Figure 6-19. TMAG5253UA Quiescent Voltage vs Temperature

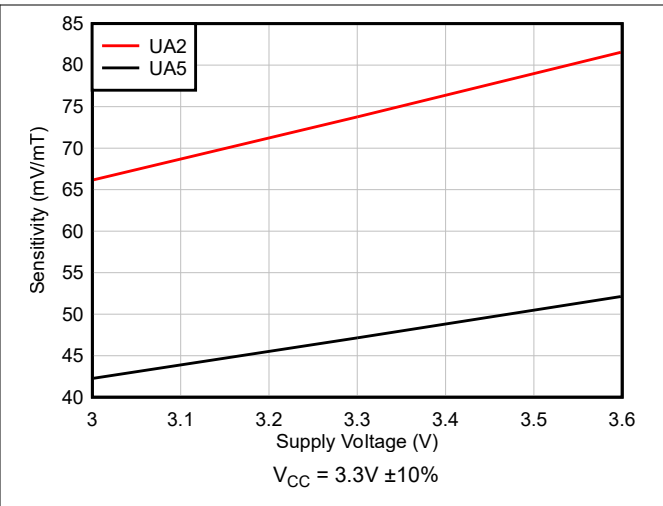

Figure 6-20. Sensitivity vs Supply Voltage

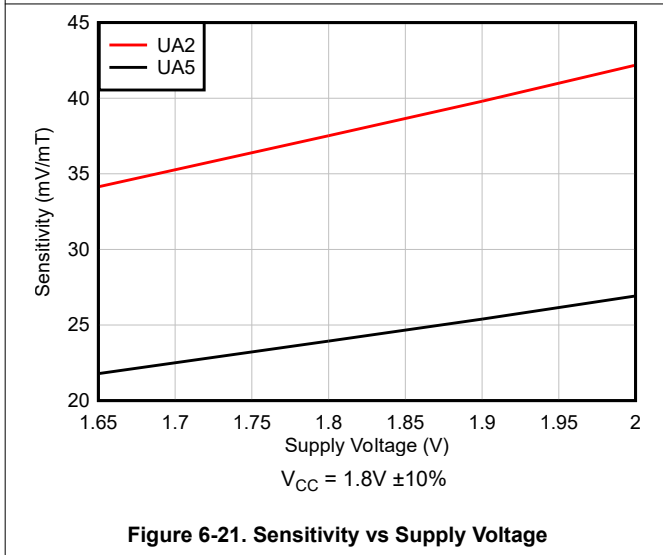

Figure 6-21. Sensitivity vs Supply Voltage

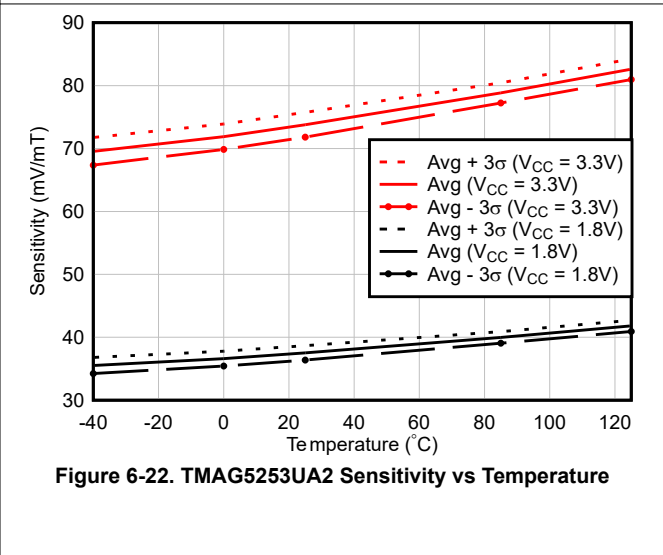

Figure 6-22. TMAG5253UA2 Sensitivity vs Temperature

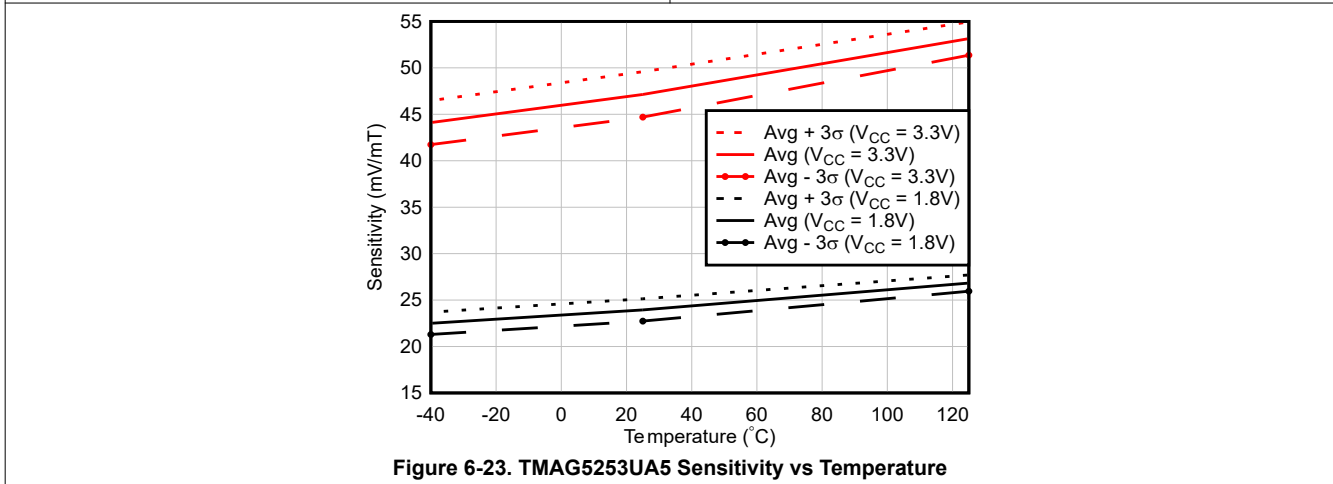
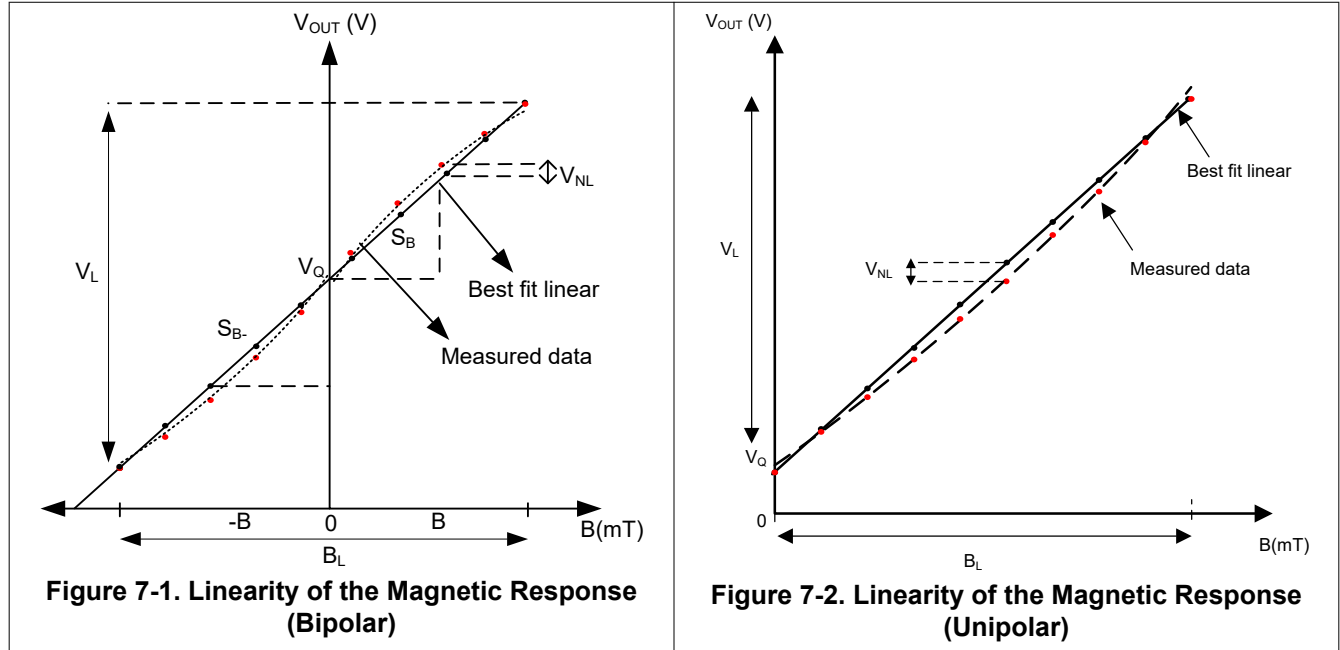

Figure 6-23. TMAG5253UA5 Sensitivity vs Temperature

## 7 Parameter Measurement Information

### 7.1 Sensitivity Linearity

The device produces a linear response when the output voltage is within the specified  $V_L$  range. Outside this range, sensitivity is reduced and nonlinear. Figure 7-1 and Figure 7-2 show the linearity of the magnetic response for bipolar and unipolar versions.



Equation 1 calculates parameter  $B_L$ , the minimum linear sensing range at 25°C, and takes the maximum quiescent voltage and sensitivity tolerance into account.

$$B_{L(MIN)} = \frac{V_{L(MAX)} - V_{Q(MAX)}}{S_{(MAX)}} \quad (1)$$

Nonlinearity is the deviation of the output voltage from a linear relationship to the input current. Nonlinearity voltage, as shown in Figure 7-1 and Figure 7-2, is the maximum voltage deviation from the best-fit line based on measured parameters (see Equation 2).

$$V_{NL} = V_{OUT} - (B_{IN} \times S_{FIT} + V_Q) \quad (2)$$

where

- $V_{OUT}$  is the voltage output at maximum deviation from best fit
- $B_{IN}$  is the magnetic flux density at maximum deviation from best fit
- $S_{FIT}$  is the best fit sensitivity of the device
- $V_Q$  is quiescent voltage at zero magnetic field ( $= V_{CC}/2$  for bipolar and 0.2V for Unipolar)

The parameter  $S_{LE}$ , Sensitivity Linearity error is the nonlinearity voltage,  $V_{NL}$  specified as a percentage of the full-scale linear output range ( $V_{FS}$ ) shown in Equation 3.

$$S_{LE} = \left( \frac{V_{NL}}{V_{FS}} \right) \times 100\% \quad (3)$$

The parameter  $S_{SE}$  defines symmetry error as the difference in sensitivity between any positive B value,  $S_B$  and the negative B value of the same magnitude,  $S_{-B}$  while the output voltage is within the  $V_L$  range. This error only applies to the bipolar device option. Use Equation 4 to calculate the symmetry error.

$$S_{SE} = \left( \frac{S_B - S_{-B}}{0.5 \times (S_B + S_{-B})} \right) \times 100\% \quad (4)$$

where

- $S_B$  refers to the sensitivity at a positive field B
- $S_{-B}$  refers to the sensitivity at a negative field B

## 7.2 Ratiometric Architecture

The TMAG5253 has a ratiometric analog architecture that scales the quiescent voltage and sensitivity linearly with the power-supply voltage. For example, the quiescent voltage and sensitivity are 5% higher when  $V_{CC} = 3.465V$  compared to  $V_{CC} = 3.3V$ . This ratiometric behavior enables an external ADC to digitize a consistent value regardless of the power-supply voltage tolerance when the ADC uses  $V_{CC}$  as the reference.

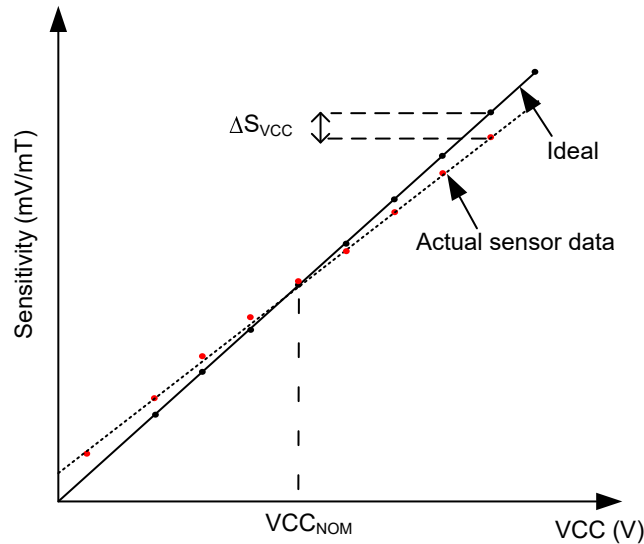

**Figure 7-3. Sensitivity Ratiometry Error**

Use Equation 5 to calculate the sensitivity ratiometry error:

$$S_{RE} = \left( 1 - \frac{S_{VCC}/S_{VCC,NOM}}{V_{VCC}/V_{VCC,NOM}} \right) \times 100\% \quad (5)$$

where

- $S_{(VCC)}$  is the sensitivity at the current  $V_{CC}$  voltage
- $S_{(NOM)}$  is the sensitivity at a nominal  $V_{CC}$  voltage
- $V_{VCC}$  is the current  $V_{CC}$  voltage
- $V_{VCC,NOM}$  is the nominal  $V_{CC}$  voltage that is 1.8V or 3.3V

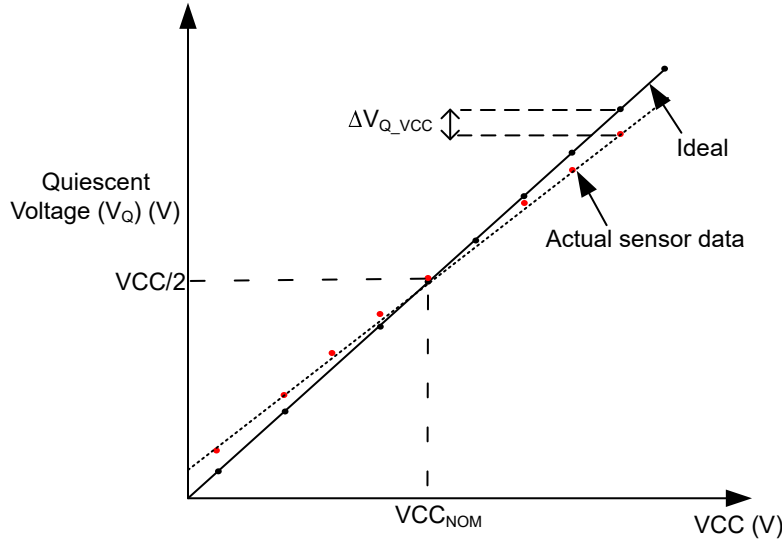

**Figure 7-4. Quiescent Ratiometry Error**

The TMAG5253 has a ratiometric architecture for the quiescent voltage of the bipolar device option. For the bipolar device option, at 0mT, the quiescent voltage is typically half of the supply voltage,  $V_{CC}$ . Use Equation 6 to calculate the quiescent voltage ratiometry error:

$$Q_{RE} = \left( 1 - \frac{V_{Q(VCC)}/V_{Q(NOM)}}{V_{VCC}/V_{VCC,NOM}} \right) \times 100\% \quad (6)$$

where

- $V_{Q(VCC)}$  is the quiescent voltage at the current  $V_{CC}$  voltage
- $V_{Q(NOM)}$  is the quiescent voltage at a nominal  $V_{CC}$  voltage
- $V_{CC}$  is the current  $V_{CC}$  voltage
- $V_{VCC,NOM}$  is the nominal  $V_{CC}$  voltage that is 1.8V or 3.3V

### 7.3 Sensitivity Temperature Compensation

Magnets generally produce weaker fields as temperature increases. Different types of magnets have different sensitivity temperature coefficients. The TMAG5253 compensates by increasing sensitivity with temperature, as defined by the parameter  $S_{TC}$ . Use Equation 7 and Equation 8 to calculate the sensitivity at a fixed supply voltage.

$$\text{Sensitivity} = \text{Sensitivity}_{25^{\circ}\text{C}} \times (1 + S_{TC} \times (T_A - 25^{\circ}\text{C})) \quad (7)$$

$$S_{TC} = \frac{100}{\text{Gain at } 25^{\circ}\text{C}} \times \frac{\text{Gain at Temp} - \text{Gain at } 25^{\circ}\text{C}}{\text{Temp} - 25} \quad (8)$$

where

- $\text{Sensitivity}_{(25^{\circ}\text{C})}$  depends on the polarity (unipolar/bipolar) and the four different device options (1, 2, 3, 4) for bipolar and one device option (5) for unipolar
- $S_{TC}$  is the Sensitivity temperature coefficient
- $T_A$  is the ambient temperature

## 7.4 Quiescent Voltage Temperature Drift

Quiescent voltage temperature drift is defined in the Magnetic Characteristic section. This can be calculated using the following equation:

$$VQ\Delta T = VQ(V_{CC}) \text{ at } 25^{\circ}\text{C} - VQ(V_{CC}) \text{ at Temp} \quad (9)$$

where

- $V_{Q(V_{CC})}$  is the quiescent voltage at the current  $V_{CC}$  voltage

## 7.5 Power-On Time

After the  $V_{CC}$  voltage is applied, the TMAG5253 requires a short initialization time before the output settles to the final value. The parameter  $T_{ON}$  describes the time from when  $V_{CC}$  crosses  $V_{CC(MIN)}$  until OUT is within 5% of the final value, with a constant magnetic field and a typical load of 100pF from OUT to ground. Figure 7-5 shows this timing diagram.

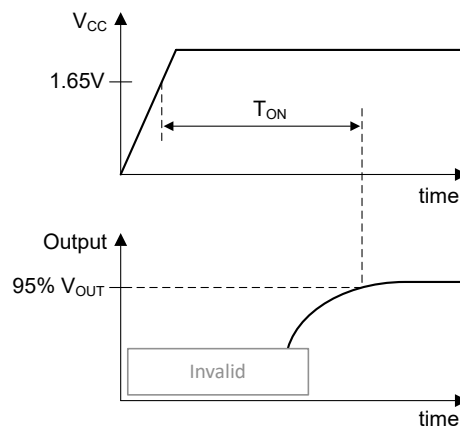

Figure 7-5.  $T_{ON}$  for  $V_{CC}$  Ramp

$T_{ON}$  is also used to describe the time from when EN pin is pulled above  $V_{IH}$  until OUT is within 5% of the final value, with a constant magnetic field and a typical load of 100pF from OUT to ground. Figure 7-6 shows this timing diagram.

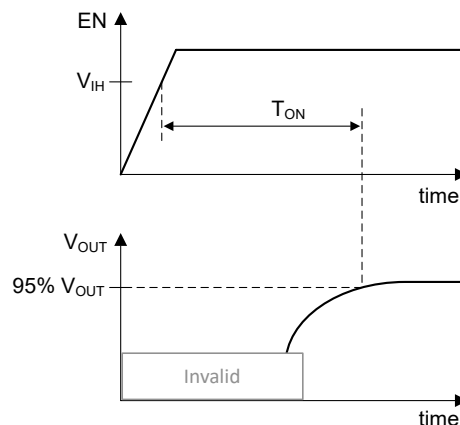

Figure 7-6.  $T_{ON}$  When Using EN Pin

## 8 Detailed Description

### 8.1 Overview

The TMAG5253 is a 4-pin, low-power linear Hall effect sensor with fully integrated signal conditioning, temperature compensation circuits, mechanical stress cancellation, and output driver. The device supports wide supply range and can operate on 1.8V or 3.3V power supplies, measures magnetic flux density, and outputs a proportional analog voltage that is referenced to  $V_{CC}$ . The device also features an enable pin that is used to place the device in a ultra-low power (nA) mode when needed.

The device is offered in bipolar magnetic response version that is sensitive to both the north and the south poles. In addition, the device is offered in unipolar magnetic response version that is sensitive to either the south or the north magnetic pole. TMAG5253 is also offered in 4 different sensitivity versions ( $\pm 20\text{mT}$ ,  $\pm 40\text{mT}$ ,  $\pm 80\text{mT}$ , or  $\pm 160\text{mT}$ ) in bipolar version and two different sensitivity version (39mT and 52mT) in unipolar version. This allows the user to trade off sensitivity range and resolution to support low cost magnet selections or wider range wherever that is needed.

The device is offered in magnetic temperature coefficient of  $0.12\%/^{\circ}\text{C}$  to compensate for magnetic sensitivity temperature coefficient of Neodymium magnet type.

### 8.2 Functional Block Diagram

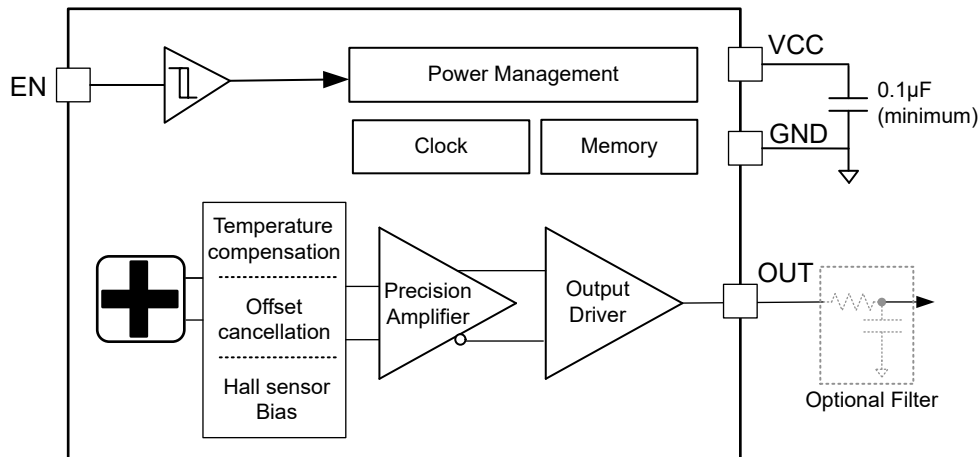

### 8.3 Feature Description

#### 8.3.1 Magnetic Flux Direction

As shown in [Figure 8-1](#), the TMAG5253 is sensitive to the magnetic field component that is perpendicular to the top of the package.

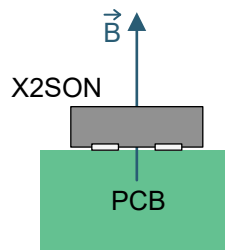

**Figure 8-1. Direction of Sensitivity**

Magnetic flux that travels from the bottom to the top of the package is considered positive in this document. This condition exists when a south magnetic pole is near the top (marked-side) of the package as shown in [Figure 8-2](#). Magnetic flux that travels from the top to the bottom of the package results in negative millitesla values.

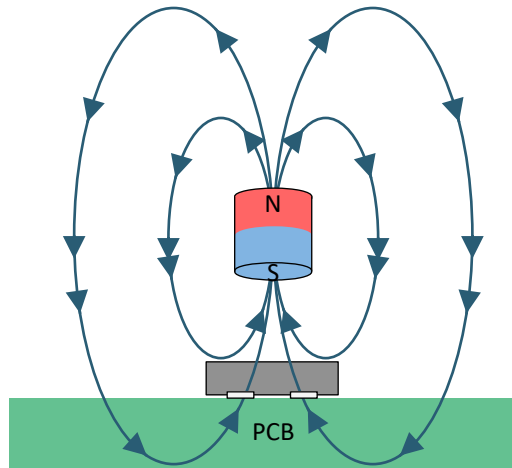

**Figure 8-2. The Flux Direction for Positive B**

**8.3.2 Hall Element Location**

[Figure 8-3](#) shows the location of the sensing element inside each package option along with the tolerances.

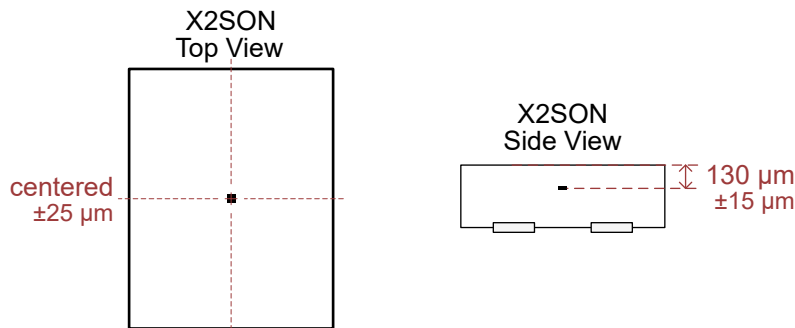

**Figure 8-3. Hall Element Location**

### 8.3.3 Magnetic Response

Figure 8-4 shows the response of the bipolar device option (B), which is sensitive to both the positive and negative magnetic fields. Figure 8-5 shows the response of the bipolar device option (U), which is sensitive to only the positive magnetic fields.

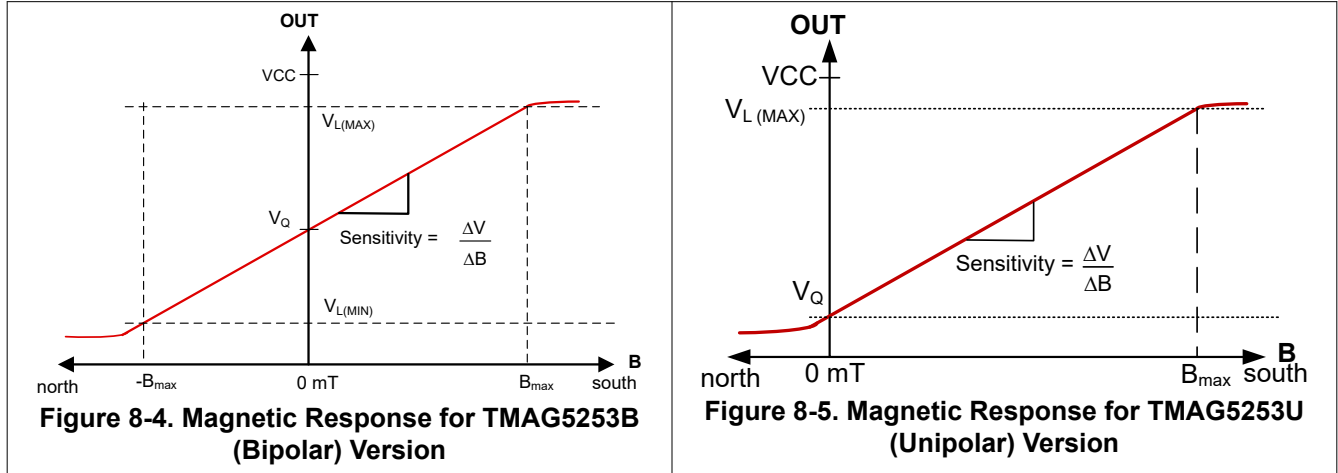

At room temperature, use Equation 10 to calculate the ideal first-order transfer function of the TMAG5253, where the output voltage is a linear function of the input magnetic field and the supply voltage.

$$V_{OUT} = V_Q + B \times \text{Sensitivity} \times \frac{V_{CC}}{V_{CC,NOM}} \quad (10)$$

where

- $V_Q$  is the quiescent output voltage for a field of 0mT.
  - $V_Q = V_{CC} / 2$  for Bipolar device option (B)
  - $V_Q = 0.2V$  for unipolar device option (U)
- B is the applied magnetic flux density
- Sensitivity refers to the magnetic sensitivity of the device
- $V_{OUT}$  is the analog output voltage within the  $V_L$  range
- $V_{CC}$  refers to the supply voltage of the device
- $V_{CC,NOM}$  is the nominal supply voltage where the sensitivity is defined, such as 1.8V or 3.3V

As an example, consider the TMAG5253BA3, a bipolar magnetic response version with a sensitivity of 15mV/mT at 3.3V supply voltage and at room temperature. With  $V_{CC} = 3.4V$  and an input field of 67mT, you can calculate the output voltage,  $V_{OUT}$  for this example.

$$V_{OUT} = 1.7V + 67mT \times 0.015 \frac{V}{mT} \times \frac{3.4V}{3.3V} = 2.735V \quad (11)$$

### 8.4 Device Functional Modes

The TMAG5253 has two modes of operations that apply when the *Recommended Operating Conditions* are met.

When the EN pin is connected to  $V_{CC}$ , the part enters active mode, where the OUT pin provides an analog output that corresponds to the magnetic sensitivity and the supply voltage.

When the EN pin is tied to GND, the TMAG5253 enters an ultra-low power shutdown mode that consumes only 20nA current. During the shutdown mode, the OUT pin is driven to a high-impedance state.

## 9 Application and Implementation

---

### Note

Information in the following applications sections is not part of the TI component specification, and TI does not warrant its accuracy or completeness. TI's customers are responsible for determining suitability of components for their purposes, as well as validating and testing their design implementation to confirm system functionality.

---

### 9.1 Application Information

#### 9.1.1 Selecting the Sensitivity Option

Select the highest TMAG5253 sensitivity option that can measure the required range of magnetic flux density so that the output voltage swing is maximized.

Larger-sized magnets and farther sensing distances can generally enable better positional accuracy than very small magnets at close distances, because magnetic flux density increases exponentially with the proximity to a magnet. TI has developed online tools to provide assistance with magnetic field calculations that assist with magnet selections and the mechanical placement of the sensor for the most common use cases.

#### 9.1.2 Temperature Compensation for Magnets

The magnetic field of magnets based on Neodymium or the Ferrite magnets have a high temperature coefficient. The residual induction ( $B_r$ ) of a magnet typically reduces by 0.12%/°C for NdFeB, and 0.20%/°C for ferrite material. The TMAG5253 features sensitivity temperature compensation that is designed to directly compensate the average drift of magnets. When the operating temperature range of a system is reduced, temperature drift errors are also reduced.

For device options BA1 to BA4, UA2 and UA5, the sensitivity at  $T_A = 125^\circ\text{C}$  is typically 12% higher than at  $T_A = 25^\circ\text{C}$ . These device options are typically used when Neodymium magnets are used along with the TMAG5253. These options are typically used when measuring ambient currents or when the magnetic field does not vary with temperature.

#### 9.1.3 Adding a Low-Pass Filter

As shown in [Functional Block Diagram](#), an RC low-pass filter can be added to the device output for the purpose of minimizing voltage noise when the full 15kHz bandwidth is not needed. This output filter can improve the signal-to-noise ratio (SNR) but at the expense of additional latency based on the external filter time constants.

### 9.1.4 Designing With Multiple Sensors

Some applications require multiple linear Hall sensors to detect position in different parts of the system. In those cases, the primary challenge is the availability of multiple ADC that are required to digitize the information from the sensors. In cases where the sensor is placed remotely away from the microcontroller, this also means multiple output lines between the sensor and microcontroller.

With the ability to place the output in high-impedance state during shutdown mode, multiple TMAG5253s can share the analog output. This can minimize the system cost by using a single ADC. Figure 9-1 shows two devices that share the same analog output, with the respective EN pins controlled by the microcontroller. A pull-down resistor can be used to pull the output to ground when both the devices are placed in shutdown mode.

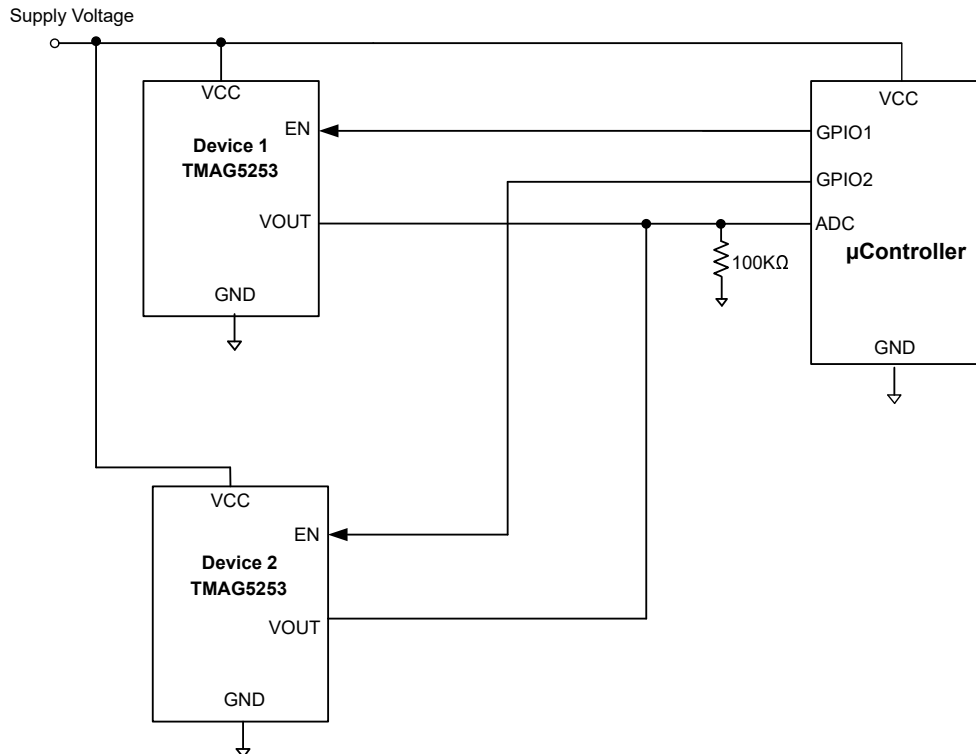

Figure 9-1. Multiple Sensors With Shared Output

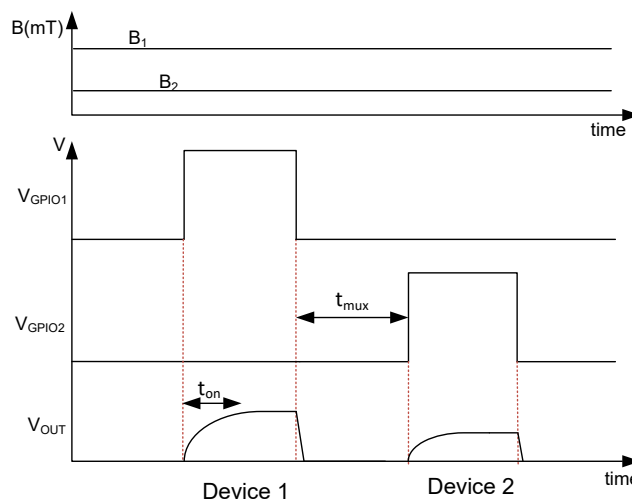

Figure 9-2. Timing Diagram for Multiplexing the Sensor Outputs

Figure 9-2 shows how the GPIOs of the microcontroller can be used to multiplex the outputs from the two sensors. When the GPIO1 goes high, Device 1 is enabled and drives the output line to the corresponding output after the power-on time. During this time, GPIO2 is driven low and Device 2 is placed in shutdown mode. When the output from the second device has to be measured, the first device must be turned off before the second device is enabled, indicated by  $t_{mux}$  in the timing diagram.  $B_1$  and  $B_2$  correspond to the magnetic fields seen by Device 1 and Device 2, respectively.

With the ability to support up to 1nF capacitive loads, the TMAG5253 enables multiple sensors to be connected to the same output. If the load capacitance on each sensor is about 20pF, this translates up to the ability of 50 sensors sharing the same output.

### 9.1.5 Duty-Cycled, Low-Power Design

For battery-powered applications where power is critical, the sensor can be duty-cycled using the EN pin. This verifies that the average current consumption remains low to meet the system level power targets. In duty-cycled applications, the start-up time must be very fast so the external ADC can sample the signal faster and shutdown the device quickly to minimize average power. With very fast start-up and power-off times, the TMAG5253 enables low average power consumption for the system.

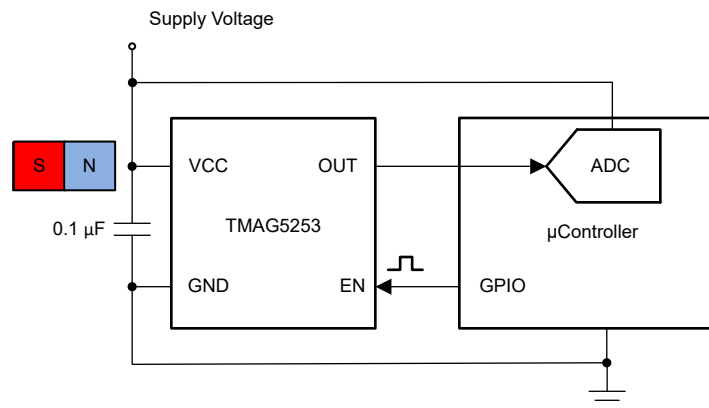

**Figure 9-3. Typical Application Diagram for Duty-Cycled Application**

Figure 9-3 shows the typical application diagram when the EN pin is controlled by the microcontroller. Figure 9-4 shows the waveforms for this application where the EN pin is duty-cycled. The sampling time of the ADC must be scheduled after the output settles down to the required resolution. Notice that the output line is pulled down by the external resistor when EN is driven low. Also, if the input magnetic field is changed when the part is in shutdown, the device provides the new output corresponding to the field after the device enters active state.

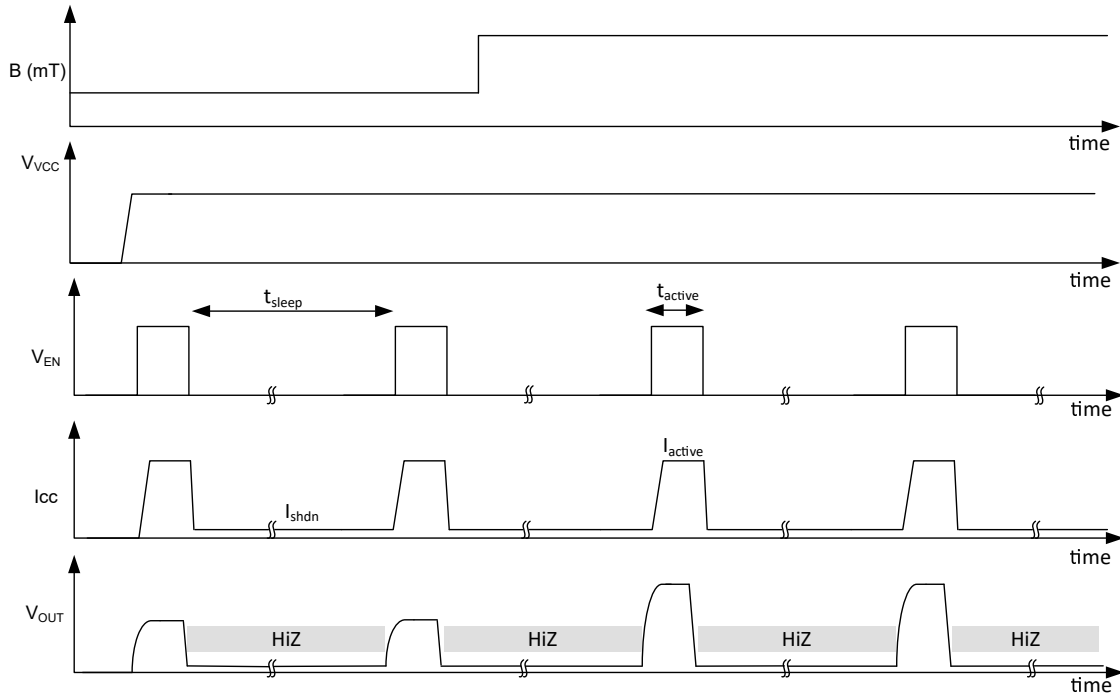

**Figure 9-4. Timing Diagram for Duty-Cycled Application**

Table 9-1 shows the estimated average current consumption for the TMAG5253 versus the sleep time, for  $V_{CC} = 1.8\text{V}$  and the EN pin is tied high for  $50\mu\text{s}$ .

**Table 9-1. Average Current Consumption**

SLEEP TIME (ms)	AVERAGE CURRENT ( $\mu\text{A}$ )
1	90.5
10	9.4
50	1.9
100	0.9
1000	0.1

## 9.2 Typical Applications

Magnetic 1D sensors are very popular due to contactless and reliable measurements, especially in applications requiring long-term measurements in rugged environments. The TMAG5253 offers design flexibility in a wide range of industrial and personal electronics applications, because many possible magnet orientations and movements produce a usable response from the sensor. In this section three common application examples are discussed in detail.

### 9.2.1 Slide-By Displacement Sensing

Figure 9-5 shows one of the most common orientations, which uses the full north to south range of the sensor and causes a close-to-linear change in magnetic flux density as the magnet moves across.

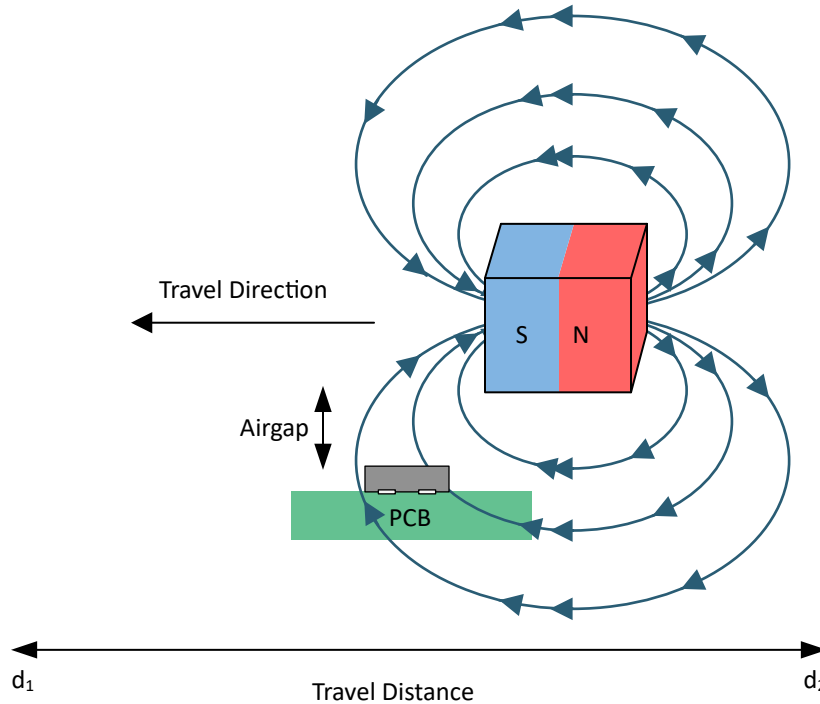

**Figure 9-5. Slide-By Sensing Magnet Orientation**

**9.2.1.1 Design Requirements**

Use the parameters listed in [Table 9-2](#) for this design example.

**Table 9-2. Design Parameters**

DESIGN PARAMETER	EXAMPLE VALUE
V <sub>CC</sub>	3.3V
Magnet	5 × 5 × 5mm NdFeB (Grade N52)
Travel distance (d <sub>2</sub> – d <sub>1</sub> )	20mm
Airgap	3.0mm (top of package to magnet) + 0.13mm (distance from top of package to sensor location)
Maximum B at sensor at 25°C	±80mT
Device option	TMAG5253BA3

**9.2.1.2 Detailed Design Procedure**

When designing a linear magnetic sensing system, always consider these three variables: the magnet, sensing distance, and the range of the sensor. Notice from [Figure 9-5](#), the magnetic flux density versus distance has both positive and negative values as the magnet slides on top of the sensor. There is a region approximately the same length of the magnet which produces a linear change in field. To measure the magnetic flux density across the entire range, select the TMAG5253B version with the highest sensitivity that has a B<sub>L</sub> (linear magnetic sensing range) that is larger than the maximum magnetic flux density in the application. With this input, the user can monitor the change in position by measuring in the linear input region. [Figure 9-6](#) shows the magnetic flux density across the three axes in the sensor location. The sensor is sensitive only to the magnetic field on Z axis, and [Figure 9-7](#) shows the output voltage from the sensor, as the magnet slides on top of the sensor.

Notice that the linear region of sensing is only around ±3.0mm, where the sensor output varies linearly with the position of the magnet. This linear range of operation increases linearly with the size of the magnet. Based on the output voltage, the sensor version with magnetic range of ±80mT is able to cover the entire magnetic

field range that is seen by the sensor. TI recommends using [magnetic field simulation software](#) and referring to magnet specifications and the mechanical placements to determine if the sensor with the right sensitivity.

### 9.2.1.3 Application Curves

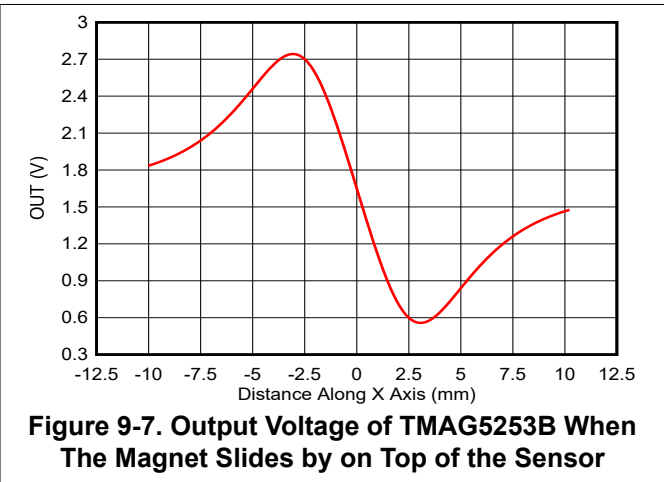
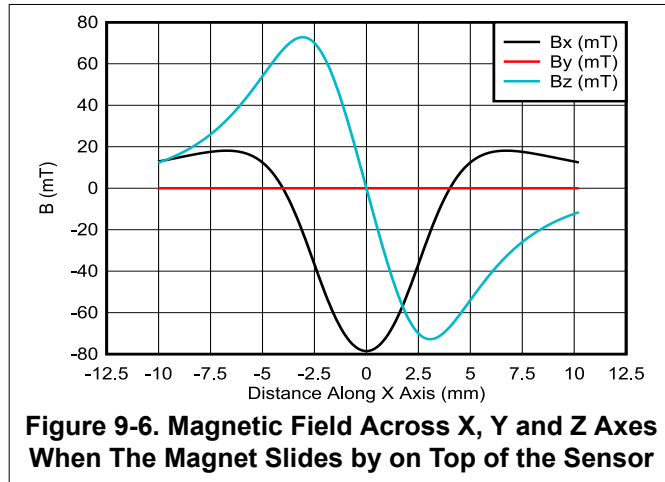

### 9.2.2 Head-On Displacement Sensing

Figure 9-8 shows another robust method for measuring linear position by using a magnet and the TMAG5253 in a head-on configuration. For this configuration, the linear axis of measurement of the Hall position sensor is along the path of travel, which results in a unique mapping of distance to magnetic flux density if the magnet is inline with the sensing axis of the Hall position sensor.

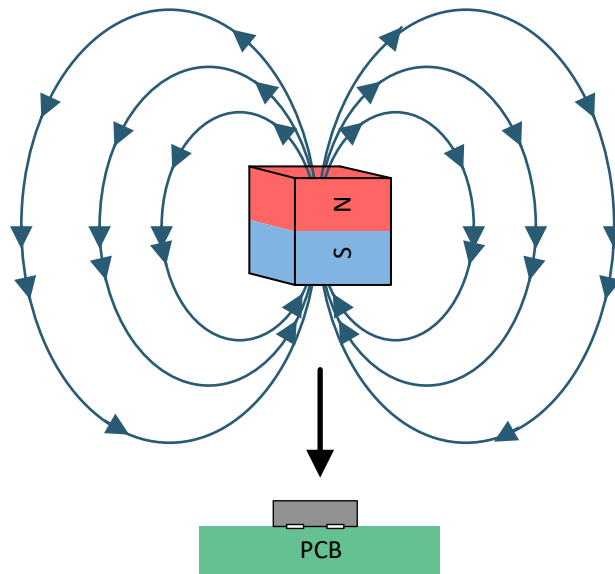

Figure 9-8. Head-On Displacement Sensing

### 9.2.2.1 Design Requirements

Use the parameters listed in [Table 9-3](#) for this design example.

**Table 9-3. Design Parameters**

DESIGN PARAMETER	EXAMPLE VALUE
$V_{CC}$	3.3V
Magnet	5 × 5 × 5mm NdFeB N45
Travel distance	5mm
Travel distance range from magnet to sensor surfaces	10mm to 5mm
Magnetic field range at the sensor at 25°C	80mT to 13mT
Device option	TMAG5253BA3

### 9.2.2.2 Detailed Design Procedure

Unlike the [Slide-By Displacement Sensing](#) configuration, the head-on displacement configuration has a magnetic flux density that is either entirely positive or entirely negative, depending on whether the south or north pole of the magnet is closest to the sensor. As a result, the user can choose the sensors that are sensitive only to south field for this mechanical configuration. In cases where controlling the polarity of the magnet is not possible, the bipolar version (TMAG5253B) is chosen. The mapping of magnetic flux density to distance depends on various factors, such as the material and dimensions of the magnet. [Figure 9-9](#) shows that the magnetic flux density is always positive as the magnet travels towards the sensor. Based on the magnetic field range, TMAG5253BA3 version with  $\pm 80\text{mT}$  full scale range is chosen. [Figure 9-9](#) shows the output voltage of this sensor as the magnet travels from a distance of 10mm to a distance of 5mm towards the sensor. The [DRV5056 Distance Measurement Tool](#) calculates the expected magnetic flux density to distance mapping in a head-on configuration for different magnet specifications.

### 9.2.2.3 Application Curve

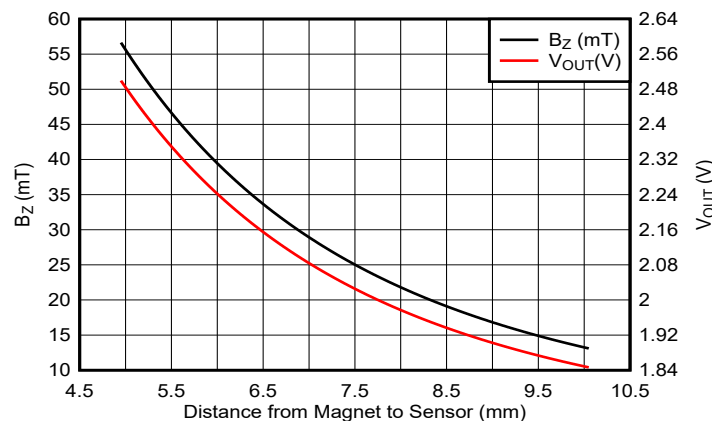

**Figure 9-9. Magnetic Field ( $B_z$ ) and the Output Voltage of the Sensor ( $V_{OUT}$ ) vs the Distance from Magnet to the Sensor in TMAG5253B**

### 9.2.3 Remote-Sensing Applications

For remote-sensing applications where the sensor is not physically placed on the same board as the ADC or the microcontroller, the ability to drive a capacitive load from the wiring harness is important. The TMAG5253 enables remote-sensing applications with the ability to support up to 1nF capacitive load on the OUT pin. With a typical cable capacitance of about 100pF/m, the TMAG5253 can support up to 10m in cable length.

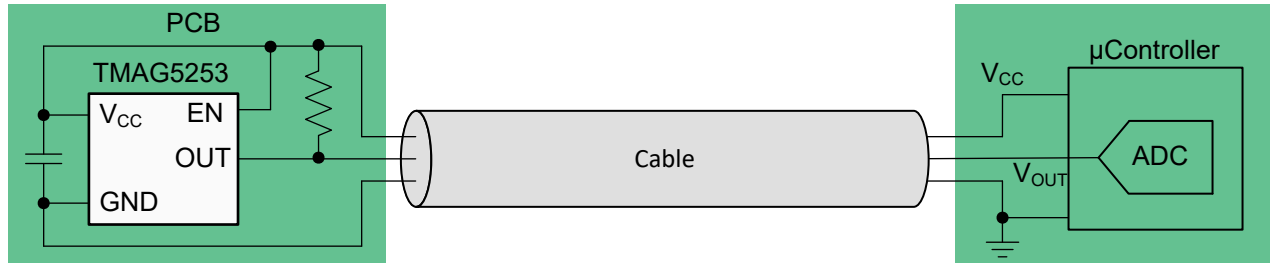

**Figure 9-10. Remote-Sensing Application With Wire Break Detection**

Some remote-sensing applications can require a device to detect if interconnect wires open or short. The TMAG5253 can support this feature with the ability to drive up to  $\pm 1\text{mA}$  current load on the output. To design for wire break detection, first select a sensitivity option that causes the output voltage to stay within the  $V_L$  range during normal operation. Second, add a pullup resistor between OUT and  $V_{CC}$ . TI recommends a value between  $20\text{k}\Omega$  to  $100\text{k}\Omega$ , and the current through OUT must not exceed the IO specification, including current going into an external ADC. Then, if the output voltage is ever measured to be within  $100\text{mV}$  of  $V_{CC}$  or GND, a fault condition exists. [Figure 9-10](#) shows the circuit, and [Table 9-4](#) describes fault scenarios.

**Table 9-4. Fault Scenarios and the Resulting  $V_{OUT}$**

FAULT SCENARIO	$V_{OUT}$
$V_{CC}$ disconnects	Close to GND
GND disconnects	Close to $V_{CC}$
$V_{CC}$ shorts to OUT	Close to $V_{CC}$
GND shorts to OUT	Close to GND

### 9.3 Best Design Practices

The Hall element is sensitive to magnetic fields that are perpendicular to the top of the package, therefore a correct magnet approach must be used for the sensor to detect the field. Figure 9-11 shows correct and incorrect approaches.

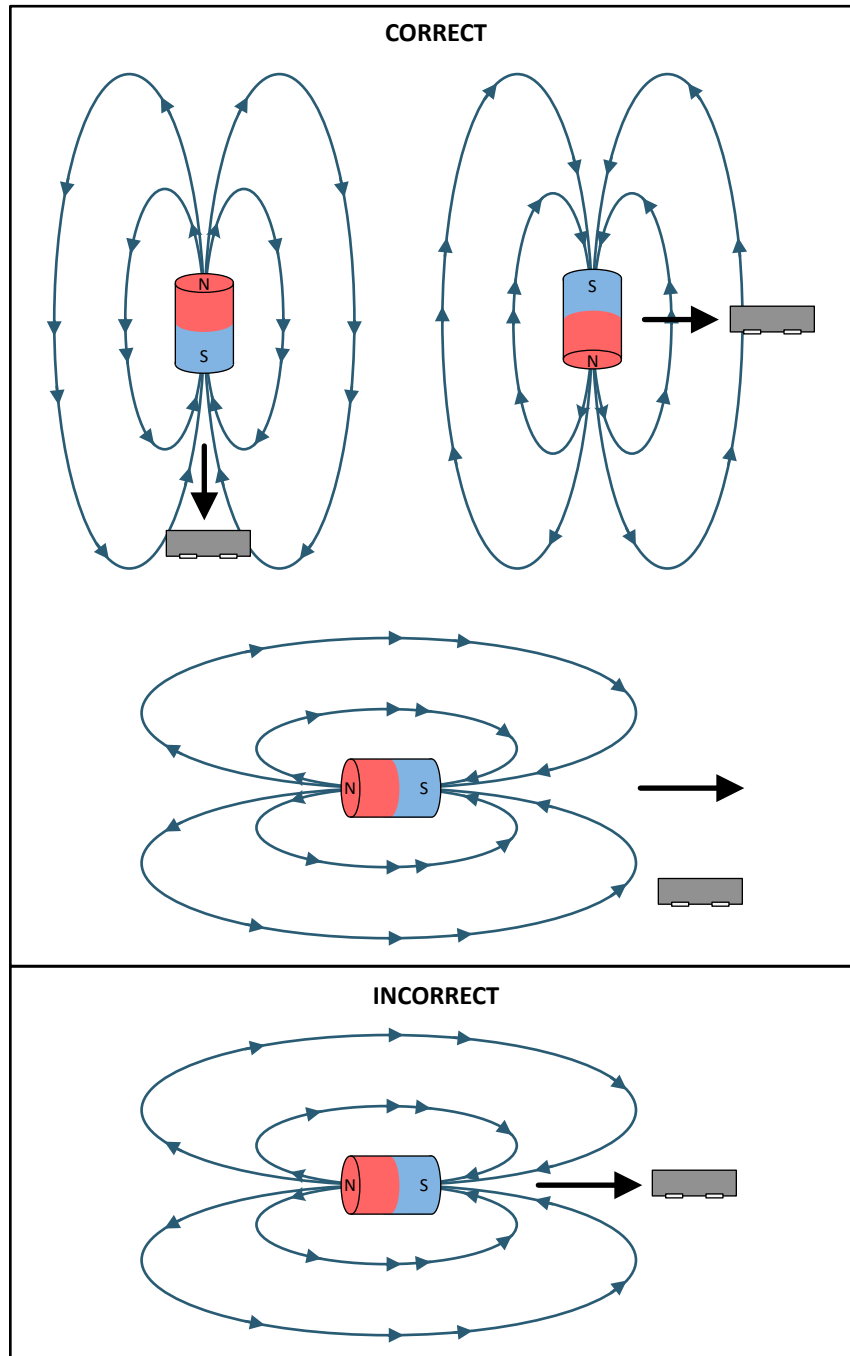

**Figure 9-11. Correct and Incorrect Magnet Approaches**

## 9.4 Power Supply Recommendations

A decoupling capacitor close to the device must be used to provide local energy with minimal inductance. TI recommends using a ceramic capacitor with a value of at least 0.1 $\mu$ F.

## 9.5 Layout

### 9.5.1 Layout Guidelines

Magnetic fields pass through most nonferromagnetic materials with no significant disturbance. Embedding Hall effect sensors within plastic or aluminum enclosures and sensing magnets on the outside is common practice. Magnetic fields also easily pass through most printed circuit boards, which makes placing the magnet on the opposite side possible.

### 9.5.2 Layout Example

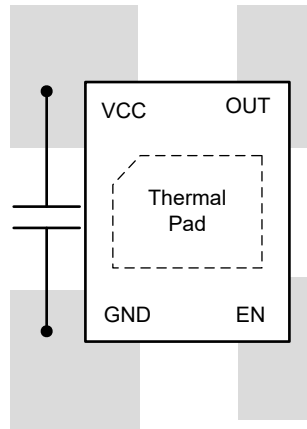

**Figure 9-12. Layout Example**

## 10 Device and Documentation Support

### 10.1 Documentation Support

#### 10.1.1 Related Documentation

For related documentation see the following:

- Texas Instruments, [Absolute Angle Measurements for Rotational Motion Using Hall-Effect Sensors application brief](#)
- Texas Instruments, [Tracking Slide-By Displacement with Hall Effect Sensors application brief](#)
- Texas Instruments, [Head-on Linear Displacement Sensing using Hall Effect Sensors application brief](#)
- Texas Instruments, [TMAG5253EVM User's Guide](#)

### 10.2 Receiving Notification of Documentation Updates

To receive notification of documentation updates, navigate to the device product folder on [ti.com](#). Click on *Notifications* to register and receive a weekly digest of any product information that has changed. For change details, review the revision history included in any revised document.

### 10.3 Support Resources

[TI E2E™ support forums](#) are an engineer's go-to source for fast, verified answers and design help — straight from the experts. Search existing answers or ask your own question to get the quick design help you need.

Linked content is provided "AS IS" by the respective contributors. They do not constitute TI specifications and do not necessarily reflect TI's views; see TI's [Terms of Use](#).

### 10.4 Trademarks

TI E2E™ is a trademark of Texas Instruments.

All trademarks are the property of their respective owners.

### 10.5 Electrostatic Discharge Caution



This integrated circuit can be damaged by ESD. Texas Instruments recommends that all integrated circuits be handled with appropriate precautions. Failure to observe proper handling and installation procedures can cause damage.

ESD damage can range from subtle performance degradation to complete device failure. Precision integrated circuits may be more susceptible to damage because very small parametric changes could cause the device not to meet its published specifications.

### 10.6 Glossary

[TI Glossary](#) This glossary lists and explains terms, acronyms, and definitions.

## 11 Revision History

NOTE: Page numbers for previous revisions may differ from page numbers in the current version.

Changes from February 1, 2026 to April 28, 2026 (from Revision D (February 2026) to Revision E (April 2026))	Page
• Added TMAG5253UA2 Unipolar version device throughout the document.....	1

Changes from Revision C (August 2025) to Revision D (February 2026)	Page
• Added TMAG5253UA5 Unipolar version device throughout the document.....	1

---

**Changes from Revision B (November 2023) to Revision C (August 2025) Page**

- Changed the minimum quiescent voltage for  $V_{CC}=3.3V$  on the BA2, BA3, BA4 variants from: 1.585V to: 1.61V..... 5
- Changed the maximum quiescent voltage for  $V_{CC}=3.3V$  on the BA2, BA3, BA4 variants from: 1.715V to: 1.69V..... 5
- Changed the maximum quiescent voltage for  $V_{CC}=1.8V$  on the BA4 variant from 0.945V to 0.93V.....5
- Changed the minimum quiescent voltage for  $V_{CC}=1.8V$  on the BA2 and BA3 variants from: 0.845V to: 0.85V 5
- Changed the maximum quiescent voltage for  $V_{CC}=1.8V$  on the BA2 and BA3 variants from: 0.945V to: 0.94V..... 5
- Changed the minimum quiescent voltage for  $V_{CC}=1.8V$  on the BA4 variant from: 0.845V to: 0.87V.....5
- Changed the maximum and minimum quiescent voltage temperature drift for  $V_{CC} = 3.3V, T_A = 0^{\circ}C$  to  $85^{\circ}C$  versus  $25^{\circ}C$ , TMAG5253B from: 60mV and -60mV to 30mV and -30mV, respectively..... 5
- Changed the maximum and minimum quiescent voltage temperature drift for  $V_{CC} = 3.3V, T_A = -40^{\circ}C$  to  $125^{\circ}C$  versus  $25^{\circ}C$ , TMAG5253B from: 100mV and -100mV to: 50mV and -50mV, respectively..... 5
- Changed the maximum and minimum quiescent voltage temperature drift for  $V_{CC} = 1.8V, T_A = 0^{\circ}C$  to  $85^{\circ}C$  versus  $25^{\circ}C$ , TMAG5253B from: 30mV and -30mV to: 25mV and -25mV, respectively..... 5
- Changed the maximum and minimum quiescent voltage temperature drift for  $V_{CC} = 1.8V, T_A = -40^{\circ}C$  to  $125^{\circ}C$  versus  $25^{\circ}C$ , TMAG5253B from: 50mV and -50mV to: 35mV and -35mV, respectively..... 5
- Added quiescent voltage temperature drift parameters for the  $T_A = 0^{\circ}C$  to  $50^{\circ}C$  range..... 5
- Changed Linear magnetic sensing range to include full temperature range..... 5

---

**Changes from Revision A (September 2023) to Revision B (November 2023) Page**

- Removed the preview note from the A1, A2 and A4 orderables in the *Device Comparison* table..... 3

---

**Changes from Revision \* (May 2023) to Revision A (September 2023) Page**

- Changed the data sheet status from: Advanced Information to: Production Data .....1

---

## 12 Mechanical, Packaging, and Orderable Information

The following pages include mechanical, packaging, and orderable information. This information is the most current data available for the designated devices. This data is subject to change without notice and revision of this document. For browser-based versions of this data sheet, refer to the left-hand navigation.

**PACKAGING INFORMATION**

Orderable part number	Status (1)	Material type (2)	Package   Pins	Package qty   Carrier	RoHS (3)	Lead finish/ Ball material (4)	MSL rating/ Peak reflow (5)	Op temp (°C)	Part marking (6)
<a href="#">TMAG5253BA1IQDMRR</a>	Active	Production	X2SON (DMR)   4	3000   LARGE T&R	Yes	SN	Level-1-260C-UNLIM	-40 to 125	BA1
TMAG5253BA1IQDMRR.A	Active	Production	X2SON (DMR)   4	3000   LARGE T&R	Yes	SN	Level-1-260C-UNLIM	-40 to 125	BA1
<a href="#">TMAG5253BA2IQDMRR</a>	Active	Production	X2SON (DMR)   4	3000   LARGE T&R	Yes	SN	Level-1-260C-UNLIM	-40 to 125	BA2
TMAG5253BA2IQDMRR.A	Active	Production	X2SON (DMR)   4	3000   LARGE T&R	Yes	SN	Level-1-260C-UNLIM	-40 to 125	BA2
<a href="#">TMAG5253BA3IQDMRR</a>	Active	Production	X2SON (DMR)   4	3000   LARGE T&R	Yes	SN	Level-1-260C-UNLIM	-40 to 125	BA3
TMAG5253BA3IQDMRR.A	Active	Production	X2SON (DMR)   4	3000   LARGE T&R	Yes	SN	Level-1-260C-UNLIM	-40 to 125	BA3
<a href="#">TMAG5253BA4IQDMRR</a>	Active	Production	X2SON (DMR)   4	3000   LARGE T&R	Yes	SN	Level-1-260C-UNLIM	-40 to 125	BA4
TMAG5253BA4IQDMRR.A	Active	Production	X2SON (DMR)   4	3000   LARGE T&R	Yes	SN	Level-1-260C-UNLIM	-40 to 125	BA4
<a href="#">TMAG5253UA2IQDMRR</a>	Active	Production	X2SON (DMR)   4	3000   LARGE T&R	Yes	SN	Level-1-260C-UNLIM	-40 to 125	UA2
<a href="#">TMAG5253UA5IQDMRR</a>	Active	Production	X2SON (DMR)   4	3000   LARGE T&R	Yes	SN	Level-1-260C-UNLIM	-40 to 125	UA5

(1) **Status:** For more details on status, see our [product life cycle](#).

(2) **Material type:** When designated, preproduction parts are prototypes/experimental devices, and are not yet approved or released for full production. Testing and final process, including without limitation quality assurance, reliability performance testing, and/or process qualification, may not yet be complete, and this item is subject to further changes or possible discontinuation. If available for ordering, purchases will be subject to an additional waiver at checkout, and are intended for early internal evaluation purposes only. These items are sold without warranties of any kind.

(3) **RoHS values:** Yes, No, RoHS Exempt. See the [TI RoHS Statement](#) for additional information and value definition.

(4) **Lead finish/Ball material:** Parts may have multiple material finish options. Finish options are separated by a vertical ruled line. Lead finish/Ball material values may wrap to two lines if the finish value exceeds the maximum column width.

(5) **MSL rating/Peak reflow:** The moisture sensitivity level ratings and peak solder (reflow) temperatures. In the event that a part has multiple moisture sensitivity ratings, only the lowest level per JEDEC standards is shown. Refer to the shipping label for the actual reflow temperature that will be used to mount the part to the printed circuit board.

(6) **Part marking:** There may be an additional marking, which relates to the logo, the lot trace code information, or the environmental category of the part.

Multiple part markings will be inside parentheses. Only one part marking contained in parentheses and separated by a "~" will appear on a part. If a line is indented then it is a continuation of the previous line and the two combined represent the entire part marking for that device.

**Important Information and Disclaimer:** The information provided on this page represents TI's knowledge and belief as of the date that it is provided. TI bases its knowledge and belief on information provided by third parties, and makes no representation or warranty as to the accuracy of such information. Efforts are underway to better integrate information from third parties. TI has taken and continues to take reasonable steps to provide representative

and accurate information but may not have conducted destructive testing or chemical analysis on incoming materials and chemicals. TI and TI suppliers consider certain information to be proprietary, and thus CAS numbers and other limited information may not be available for release.

In no event shall TI's liability arising out of such information exceed the total purchase price of the TI part(s) at issue in this document sold by TI to Customer on an annual basis.

**TAPE AND REEL INFORMATION**

**QUADRANT ASSIGNMENTS FOR PIN 1 ORIENTATION IN TAPE**

\*All dimensions are nominal

Device	Package Type	Package Drawing	Pins	SPQ	Reel Diameter (mm)	Reel Width W1 (mm)	A0 (mm)	B0 (mm)	K0 (mm)	P1 (mm)	W (mm)	Pin1 Quadrant
TMAG5253BA1IQDMRR	X2SON	DMR	4	3000	179.0	8.4	1.27	1.57	0.5	4.0	8.0	Q1
TMAG5253BA2IQDMRR	X2SON	DMR	4	3000	179.0	8.4	1.27	1.57	0.5	4.0	8.0	Q1
TMAG5253BA3IQDMRR	X2SON	DMR	4	3000	179.0	8.4	1.27	1.57	0.5	4.0	8.0	Q1
TMAG5253BA4IQDMRR	X2SON	DMR	4	3000	179.0	8.4	1.27	1.57	0.5	4.0	8.0	Q1
TMAG5253UA2IQDMRR	X2SON	DMR	4	3000	180.0	8.4	1.27	1.57	0.5	4.0	8.0	Q1
TMAG5253UA5IQDMRR	X2SON	DMR	4	3000	180.0	8.4	1.27	1.57	0.5	4.0	8.0	Q1

**TAPE AND REEL BOX DIMENSIONS**

\*All dimensions are nominal

Device	Package Type	Package Drawing	Pins	SPQ	Length (mm)	Width (mm)	Height (mm)
TMAG5253BA1IQDMRR	X2SON	DMR	4	3000	200.0	183.0	25.0
TMAG5253BA2IQDMRR	X2SON	DMR	4	3000	200.0	183.0	25.0
TMAG5253BA3IQDMRR	X2SON	DMR	4	3000	200.0	183.0	25.0
TMAG5253BA4IQDMRR	X2SON	DMR	4	3000	200.0	183.0	25.0
TMAG5253UA2IQDMRR	X2SON	DMR	4	3000	200.0	183.0	25.0
TMAG5253UA5IQDMRR	X2SON	DMR	4	3000	200.0	183.0	25.0

## GENERIC PACKAGE VIEW

**DMR 4**

**X2SON - 0.4 mm max height**

1.1 x 1.4, 0.5 mm pitch

PLASTIC SMALL OUTLINE - NO LEAD

This image is a representation of the package family, actual package may vary.  
Refer to the product data sheet for package details.



4229480/A

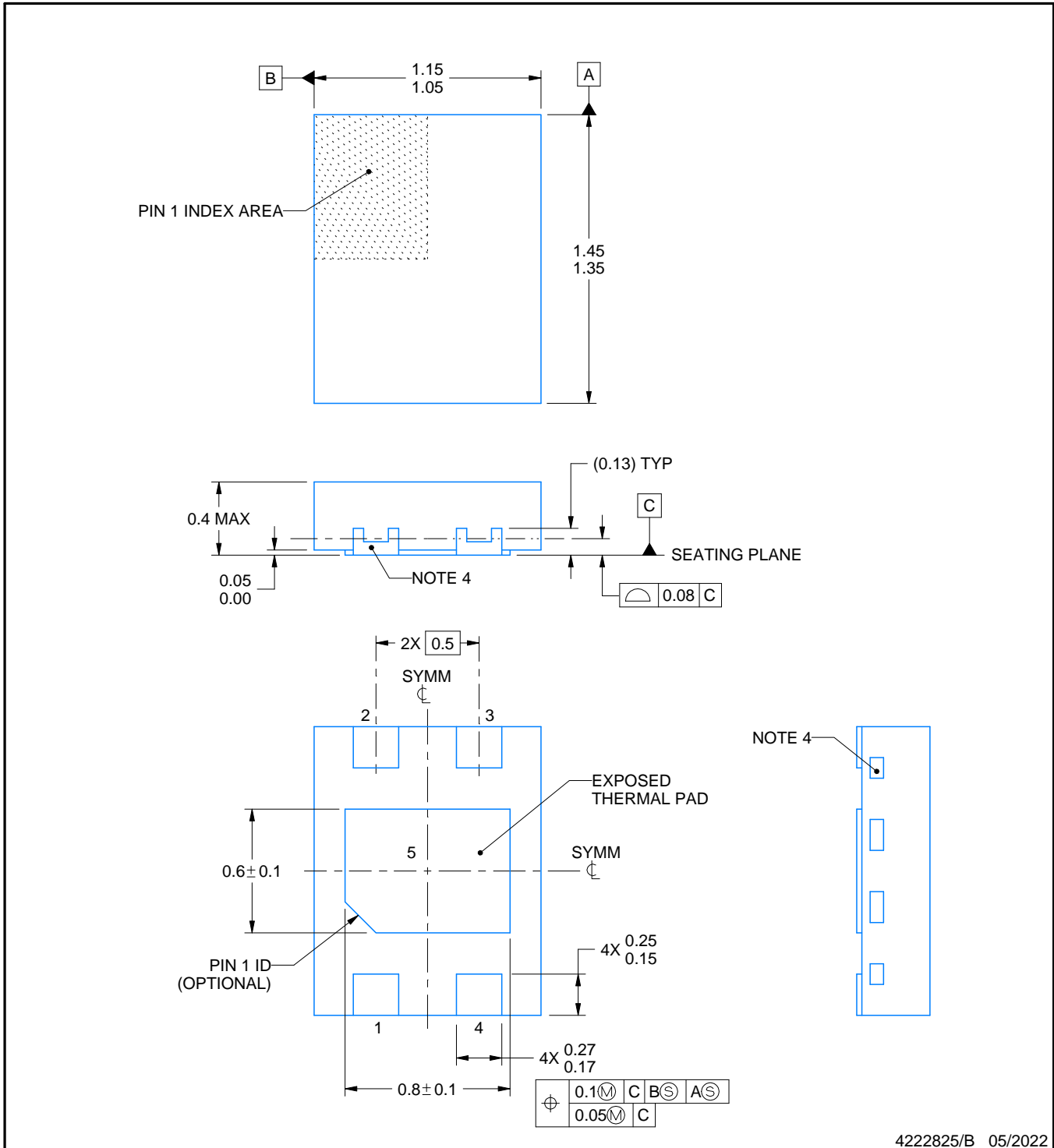
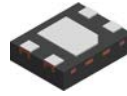

4222825/B 05/2022

NOTES:

1. All linear dimensions are in millimeters. Any dimensions in parenthesis are for reference only. Dimensioning and tolerancing per ASME Y14.5M.
2. This drawing is subject to change without notice.
3. The package thermal pad must be soldered to the printed circuit board for thermal and mechanical performance.
4. Quantity and shape of side wall metal may vary.

# EXAMPLE BOARD LAYOUT

DMR0004A

X2SON - 0.4 mm max height

PLASTIC SMALL OUTLINE - NO LEAD

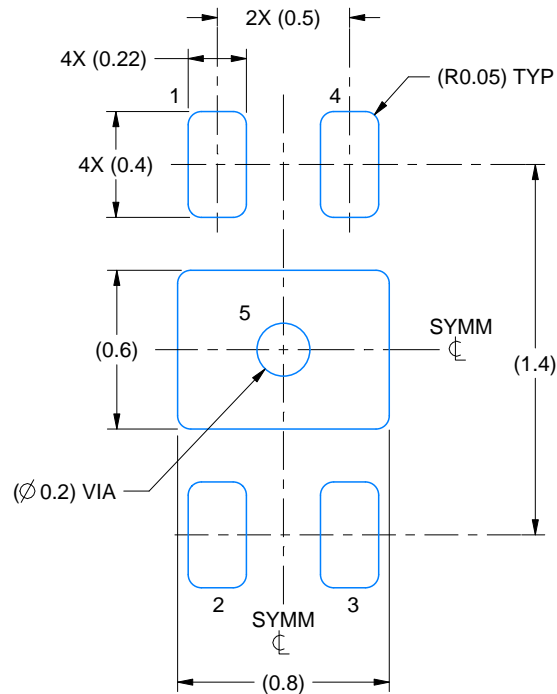

LAND PATTERN EXAMPLE  
SCALE:35X

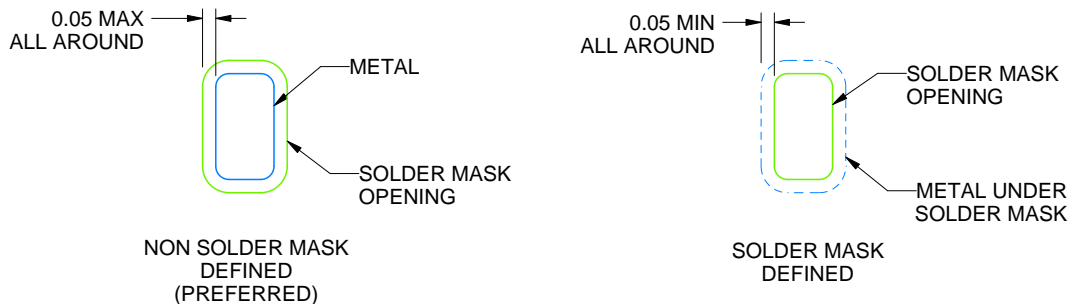

SOLDER MASK DETAILS

4222825/B 05/2022

NOTES: (continued)

5. This package is designed to be soldered to a thermal pad on the board. For more information, see Texas Instruments literature number SLUA271 ([www.ti.com/lit/slua271](http://www.ti.com/lit/slua271)).
6. Vias are optional depending on application, refer to device data sheet. If all or some are implemented, recommended via locations are shown. It is recommended that vias under paste be filled, plugged or tented.

# EXAMPLE STENCIL DESIGN

DMR0004A

X2SON - 0.4 mm max height

PLASTIC SMALL OUTLINE - NO LEAD

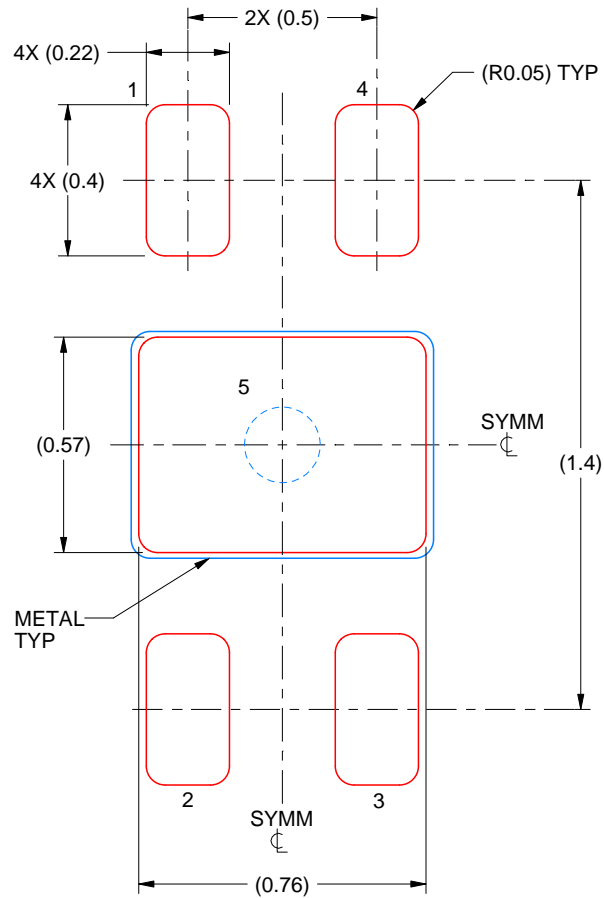

SOLDER PASTE EXAMPLE  
BASED ON 0.1 mm THICK STENCIL

EXPOSED PAD 5:  
90% PRINTED SOLDER COVERAGE BY AREA  
SCALE:50X

4222825/B 05/2022

NOTES: (continued)

7. Laser cutting apertures with trapezoidal walls and rounded corners may offer better paste release. IPC-7525 may have alternate design recommendations.

## IMPORTANT NOTICE AND DISCLAIMER

TI PROVIDES TECHNICAL AND RELIABILITY DATA (INCLUDING DATASHEETS), DESIGN RESOURCES (INCLUDING REFERENCE DESIGNS), APPLICATION OR OTHER DESIGN ADVICE, WEB TOOLS, SAFETY INFORMATION, AND OTHER RESOURCES "AS IS" AND WITH ALL FAULTS, AND DISCLAIMS ALL WARRANTIES, EXPRESS AND IMPLIED, INCLUDING WITHOUT LIMITATION ANY IMPLIED WARRANTIES OF MERCHANTABILITY, FITNESS FOR A PARTICULAR PURPOSE OR NON-INFRINGEMENT OF THIRD PARTY INTELLECTUAL PROPERTY RIGHTS.

These resources are intended for skilled developers designing with TI products. You are solely responsible for (1) selecting the appropriate TI products for your application, (2) designing, validating and testing your application, and (3) ensuring your application meets applicable standards, and any other safety, security, regulatory or other requirements.

These resources are subject to change without notice. TI grants you permission to use these resources only for development of an application that uses the TI products described in the resource. Other reproduction and display of these resources is prohibited. No license is granted to any other TI intellectual property right or to any third party intellectual property right. TI disclaims responsibility for, and you fully indemnify TI and its representatives against any claims, damages, costs, losses, and liabilities arising out of your use of these resources.

TI's products are provided subject to [TI's Terms of Sale](#), [TI's General Quality Guidelines](#), or other applicable terms available either on [ti.com](http://ti.com) or provided in conjunction with such TI products. TI's provision of these resources does not expand or otherwise alter TI's applicable warranties or warranty disclaimers for TI products. Unless TI explicitly designates a product as custom or customer-specified, TI products are standard, catalog, general purpose devices.

TI objects to and rejects any additional or different terms you may propose.

Copyright © 2026, Texas Instruments Incorporated

Last updated 10/2025