

TPS76130, TPS76132, TPS76133, TPS76138, TPS76150 LOW-POWER 100-mA LOW-DROPOUT LINEAR REGULATORS

SLVS178B – DECEMBER 1998 – REVISED MAY 2001

- 100-mA Low-Dropout Regulator
- Fixed Output Voltage Options: 5 V, 3.8 V, 3.3 V, 3.2 V, and 3 V
- Dropout Typically 170 mV at 100-mA
- Thermal Protection
- Less Than 1 μ A Quiescent Current in Shutdown
- -40°C to 125°C Operating Junction Temperature Range
- 5-Pin SOT-23 (DBV) Package
- ESD Protection Verified to 1.5 KV Human Body Model (HBM) per MIL-STD-883C

DBV PACKAGE
(TOP VIEW)

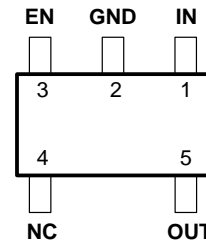

NC – No internal connection

description

The TPS761xx is a 100 mA, low dropout (LDO) voltage regulator designed specifically for battery-powered applications. A proprietary BiCMOS fabrication process allows the TPS761xx to provide outstanding performance in all specifications critical to battery-powered operation.

The TPS761xx is available in a space-saving SOT-23 (DBV) package and operates over a junction temperature range of -40°C to 125°C .

AVAILABLE OPTIONS

T _J	VOLTAGE	PACKAGE	PART NUMBER		SYMBOL
-40°C to 125°C	3 V	SOT-23 (DBV)	TPS76130DBVR†	TPS76130DBVT‡	PAEI
	3.2 V		TPS76132DBVR†	TPS76132DBVT‡	PAFI
	3.3 V		TPS76133DBVR†	TPS76133DBVT‡	PAII
	3.8 V		TPS76138DBVR†	TPS76138DBVT‡	PAKI
	5 V		TPS76150DBVR†	TPS76150DBVT‡	PALI

† The DBVR passive indicates tape and reel of 3000 parts.

‡ The DBVT passive indicates tape and reel of 250 parts.

functional block diagram

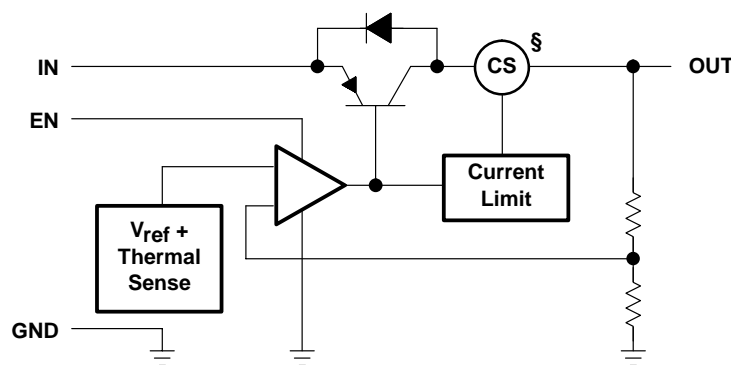

§ Current sense



Please be aware that an important notice concerning availability, standard warranty, and use in critical applications of Texas Instruments semiconductor products and disclaimers thereto appears at the end of this data sheet.

PRODUCTION DATA information is current as of publication date. Products conform to specifications per the terms of Texas Instruments standard warranty. Production processing does not necessarily include testing of all parameters.

**TEXAS
INSTRUMENTS**

POST OFFICE BOX 655303 • DALLAS, TEXAS 75265

Copyright © 2001, Texas Instruments Incorporated

TPS76130, TPS76132, TPS76133, TPS76138, TPS76150

LOW-POWER 100-mA LOW-DROPOUT LINEAR REGULATORS

SLVS178B – DECEMBER 1998 – REVISED MAY 2001

Terminal Functions

TERMINAL NAME	NO.	I/O	DESCRIPTION
EN	3	I	Enable input
GND	2		Ground
IN	1	I	Input voltage
NC	4		No connection
OUT	5	O	Regulated output voltage

absolute maximum ratings over operating free-air temperature range (unless otherwise noted)†

Input voltage range, V_I (see Note 1)	–0.3 V to 16 V
Voltage range at EN	–0.3 V to $V_I + 0.3$ V
Peak output current	internally limited
Continuous total dissipation	See Dissipation Rating Table
Operating junction temperature range, T_J	–40°C to 150°C
Storage temperature range, T_{stg}	–65°C to 150°C
ESD rating, HBM	1.5 kV

† Stresses beyond those listed under “absolute maximum ratings” may cause permanent damage to the device. These are stress ratings only, and functional operation of the device at these or any other conditions beyond those indicated under “recommended operating conditions” is not implied. Exposure to absolute-maximum-rated conditions for extended periods may affect device reliability.

NOTE 1: All voltages are with respect to device GND pin.

DISSIPATION RATING TABLE

BOARD	PACKAGE	$R_{\theta JC}$	$R_{\theta JA}$	DERATING FACTOR ABOVE $T_A = 25^\circ\text{C}$	$T_A \leq 25^\circ\text{C}$ POWER RATING	$T_A = 70^\circ\text{C}$ POWER RATING	$T_A = 85^\circ\text{C}$ POWER RATING
Low K‡	DBV	65.8 °C/W	259 °C/W	3.9 mW/°C	386 mW	212 mW	154 mW
High K§	DBV	65.8 °C/W	180 °C/W	5.6 mW/°C	555 mW	305 mW	222 mW

‡ The JEDEC Low K (1s) board design used to derive this data was a 3 inch x 3 inch, two layer board with 2 ounce copper traces on top of the board.

§ The JEDEC High K (2s2p) board design used to derive this data was a 3 inch x 3 inch, multilayer board with 1 ounce internal power and ground planes and 2 ounce copper traces on top and bottom of the board.

recommended operating conditions

	MIN	NOM	MAX	UNIT
Input voltage, V_I	TPS76130	3.35	16	V
	TPS76132	3.58	16	
	TPS76133	3.68	16	
	TPS76138	4.18	16	
	TPS76150	5.38	16	
Continuous output current, I_O	0		100	mA
Operating junction temperature, T_J	–40		125	°C



TPS76130, TPS76132, TPS76133, TPS76138, TPS76150 LOW-POWER 100-mA LOW-DROPOUT LINEAR REGULATORS

SLVS178B – DECEMBER 1998 – REVISED MAY 2001

electrical characteristics over recommended operating free-air temperature range,
 $V_I = V_{O(\text{typ})} + 1 \text{ V}$, $I_O = 1 \text{ mA}$, $EN = V_I$, $C_O = 4.7 \mu\text{F}$ (unless otherwise noted)

PARAMETER		TEST CONDITIONS	MIN	TYP	MAX	UNIT
V_O	TPS76130	$T_J = 25^\circ\text{C}$	2.96	3	3.04	V
		$T_J = 25^\circ\text{C}$, $1 \text{ mA} < I_O < 100 \text{ mA}$	2.9		3.04	
		$1 \text{ mA} < I_O < 100 \text{ mA}$	2.89		3.07	
	TPS76132	$T_J = 25^\circ\text{C}$	3.16	3.2	3.24	V
		$T_J = 25^\circ\text{C}$, $1 \text{ mA} < I_O < 100 \text{ mA}$	3.11		3.24	
		$1 \text{ mA} < I_O < 100 \text{ mA}$	3.08		3.3	
	TPS76133	$T_J = 25^\circ\text{C}$	3.26	3.3	3.34	V
		$T_J = 25^\circ\text{C}$, $1 \text{ mA} < I_O < 100 \text{ mA}$	3.21		3.34	
		$1 \text{ mA} < I_O < 100 \text{ mA}$	3.18		3.4	
	TPS76138	$T_J = 25^\circ\text{C}$	3.76	3.8	3.84	V
		$T_J = 25^\circ\text{C}$, $1 \text{ mA} < I_O < 100 \text{ mA}$	3.71		3.84	
		$1 \text{ mA} < I_O < 100 \text{ mA}$	3.68		3.9	
	TPS76150	$T_J = 25^\circ\text{C}$	4.95	5	5.05	V
		$T_J = 25^\circ\text{C}$, $1 \text{ mA} < I_O < 100 \text{ mA}$	4.88		5.05	
		$1 \text{ mA} < I_O < 100 \text{ mA}$	4.86		5.1	
$I_I(\text{standby})$	Standby current	$EN = 0 \text{ V}$			1	μA
	Quiescent current (GND current)	$I_O = 0 \text{ mA}$, $T_J = 25^\circ\text{C}$		90	115	μA
		$I_O = 0 \text{ mA}$			130	
		$I_O = 1 \text{ mA}$, $T_J = 25^\circ\text{C}$		100	130	
		$I_O = 1 \text{ mA}$			170	
		$I_O = 10 \text{ mA}$, $T_J = 25^\circ\text{C}$		190	220	
		$I_O = 10 \text{ mA}$			260	
		$I_O = 50 \text{ mA}$, $T_J = 25^\circ\text{C}$		850	1100	
		$I_O = 50 \text{ mA}$			1200	
		$I_O = 100 \text{ mA}$, $T_J = 25^\circ\text{C}$		2600	3600	
		$I_O = 100 \text{ mA}$			4000	
Input regulation	TPS76130	$4 \text{ V} < V_I < 16$, $I_O = 1 \text{ mA}$		3	10	mV
	TPS76132	$4.2 \text{ V} < V_I < 16$, $I_O = 1 \text{ mA}$		3	10	
	TPS76133	$4.3 \text{ V} < V_I < 16$, $I_O = 1 \text{ mA}$		3	10	
	TPS76138	$4.8 \text{ V} < V_I < 16$, $I_O = 1 \text{ mA}$		3	10	
	TPS76150	$6 \text{ V} < V_I < 16$, $I_O = 1 \text{ mA}$		3	10	
V_N	Output noise voltage	$BW = 300 \text{ Hz to } 50 \text{ kHz}$ $C_O = 10 \mu\text{F}$, $T_J = 25^\circ\text{C}$		190		μVrms
	Ripple rejection	$f = 1 \text{ kHz}$, $C_O = 10 \mu\text{F}$, $T_J = 25^\circ\text{C}$		63		dB



TPS76130, TPS76132, TPS76133, TPS76138, TPS76150 LOW-POWER 100-mA LOW-DROPOUT LINEAR REGULATORS

SLVS178B – DECEMBER 1998 – REVISED MAY 2001

electrical characteristics over recommended operating free-air temperature range,
 $V_I = V_O(\text{typ}) + 1 \text{ V}$, $I_O = 1 \text{ mA}$, $EN = V_I$, $C_O = 4.7 \mu\text{F}$ (unless otherwise noted) (continued)

PARAMETER	TEST CONDITIONS	MIN	TYP	MAX	UNIT
Dropout voltage	$I_O = 0 \text{ mA}$, $T_J = 25^\circ\text{C}$		1	3	mV
	$I_O = 0 \text{ mA}$			5	
	$I_O = 1 \text{ mA}$, $T_J = 25^\circ\text{C}$		7	10	
	$I_O = 1 \text{ mA}$			15	
	$I_O = 10 \text{ mA}$, $T_J = 25^\circ\text{C}$		40	60	
	$I_O = 10 \text{ mA}$			90	
	$I_O = 50 \text{ mA}$, $T_J = 25^\circ\text{C}$		120	150	
	$I_O = 50 \text{ mA}$			180	
	$I_O = 100 \text{ mA}$, $T_J = 25^\circ\text{C}$		170	240	
	$I_O = 100 \text{ mA}$			280	
Peak output current/current limit		100	125	135	mA
High level enable input		2			V
Low level enable input				0.8	V
I_I Input current (EN)	$EN = 0 \text{ V}$	-1	0	1	μA
	$EN = V_I$		2.5	5	

TYPICAL CHARACTERISTICS

Table of Graphs

			FIGURE
V_O	Output voltage	vs Output current	1, 2, 3
		vs Free-air temperature	4, 5, 6
	Ground current	vs Free-air temperature	7, 8, 9
	Output noise	vs Frequency	10
Z_O	Output impedance	vs Frequency	11
V_{DO}	Dropout voltage	vs Free-air temperature	12
	Line transient response		13, 15
	Load transient response		14, 16



TYPICAL CHARACTERISTICS

TPS76130
 OUTPUT VOLTAGE
 vs
 OUTPUT CURRENT



Figure 1

TPS76133
 OUTPUT VOLTAGE
 vs
 OUTPUT CURRENT



Figure 2

TPS76150
 OUTPUT VOLTAGE
 vs
 OUTPUT CURRENT



Figure 3

TPS76130
 OUTPUT VOLTAGE
 vs
 FREE-AIR TEMPERATURE

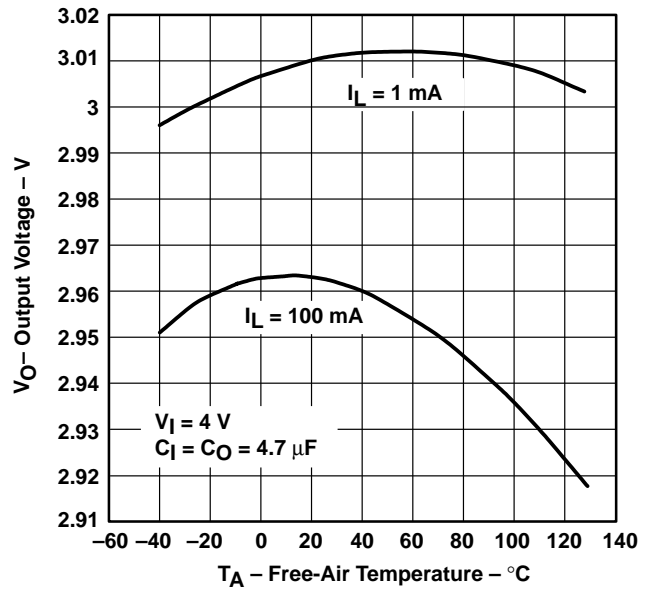

Figure 4

TPS76130, TPS76132, TPS76133, TPS76138, TPS76150 LOW-POWER 100-mA LOW-DROPOUT LINEAR REGULATORS

SLVS178B – DECEMBER 1998 – REVISED MAY 2001

TYPICAL CHARACTERISTICS

TPS76133
OUTPUT VOLTAGE
vs
FREE-AIR TEMPERATURE

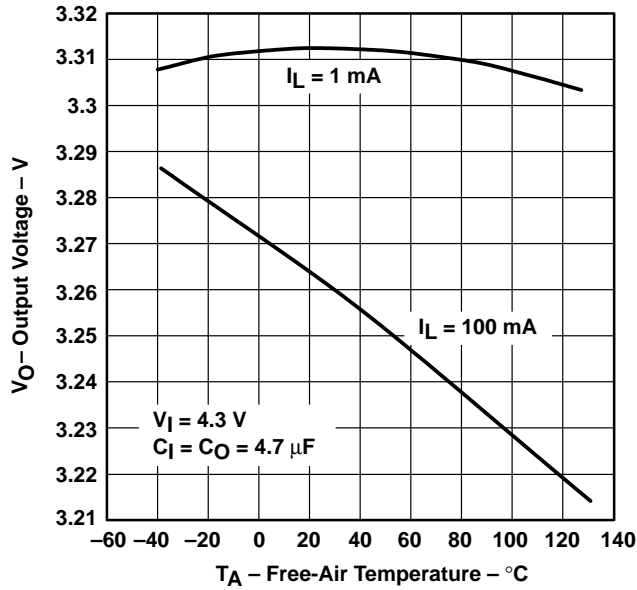

Figure 5

TPS76150
OUTPUT VOLTAGE
vs
FREE-AIR TEMPERATURE

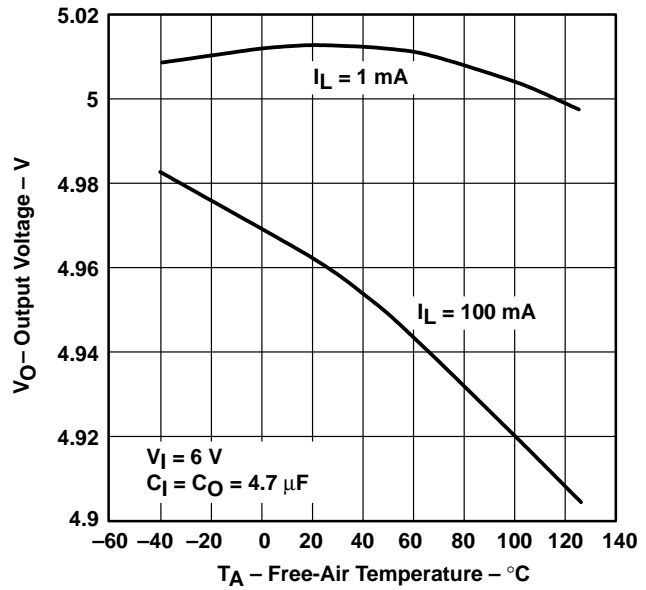

Figure 6

TPS76130
GROUND CURRENT
vs
FREE-AIR TEMPERATURE

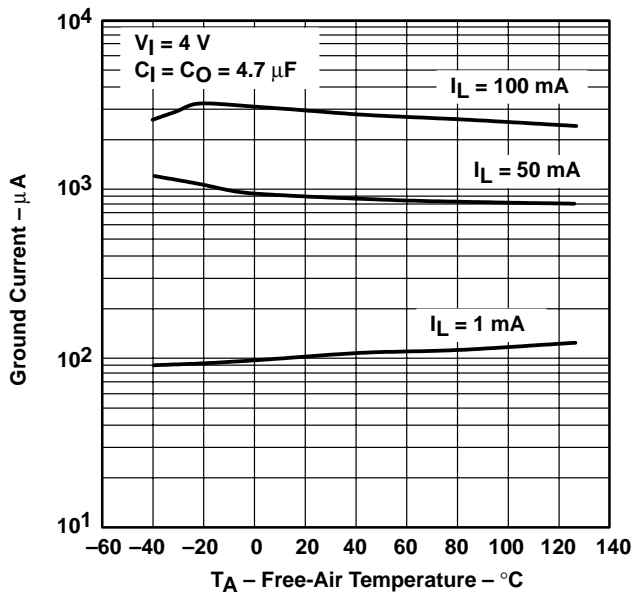

Figure 7

TPS76133
GROUND CURRENT
vs
FREE-AIR TEMPERATURE

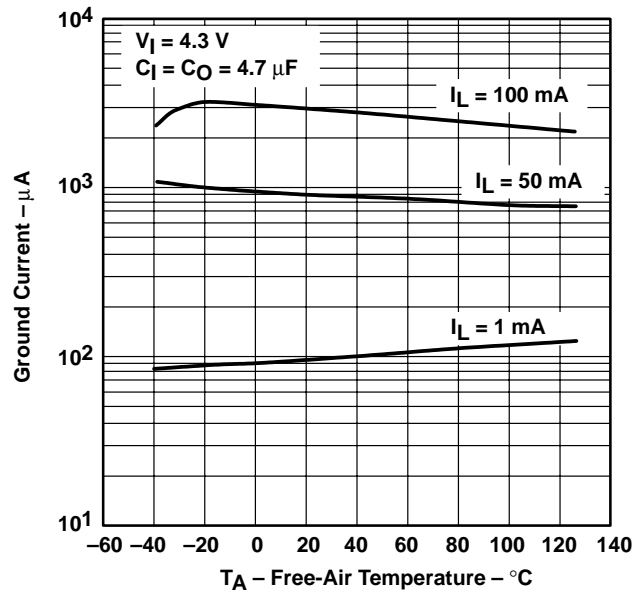

Figure 8



TYPICAL CHARACTERISTICS

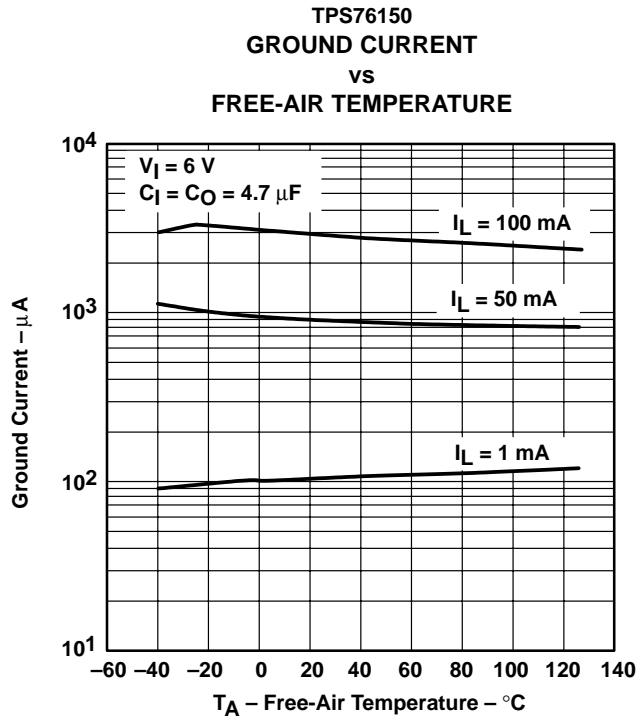

Figure 9



Figure 10

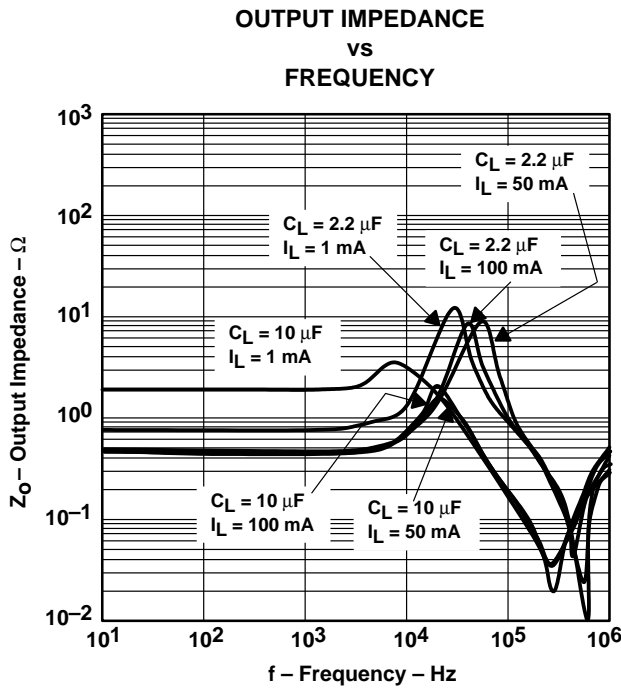

Figure 11

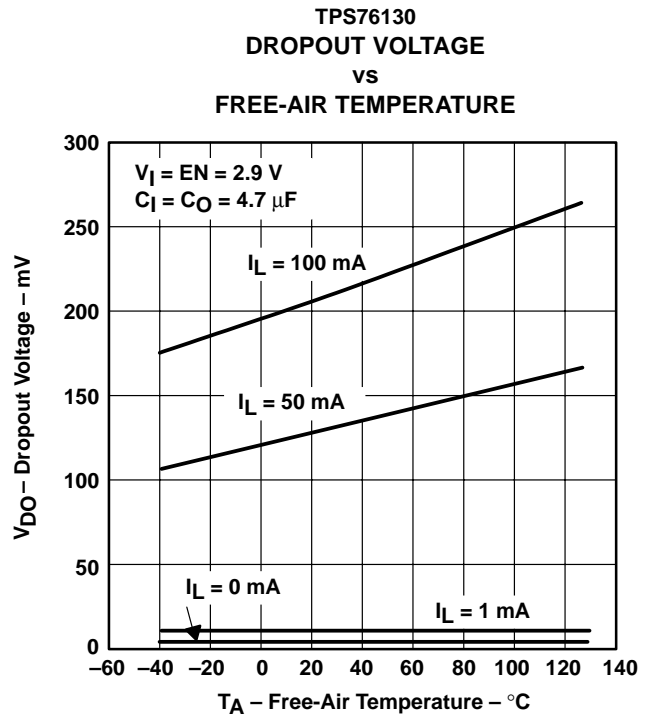

Figure 12

TPS76130, TPS76132, TPS76133, TPS76138, TPS76150

LOW-POWER 100-mA LOW-DROPOUT LINEAR REGULATORS

SLVS178B – DECEMBER 1998 – REVISED MAY 2001

TYPICAL CHARACTERISTICS

TPS76130
LINE TRANSIENT RESPONSE

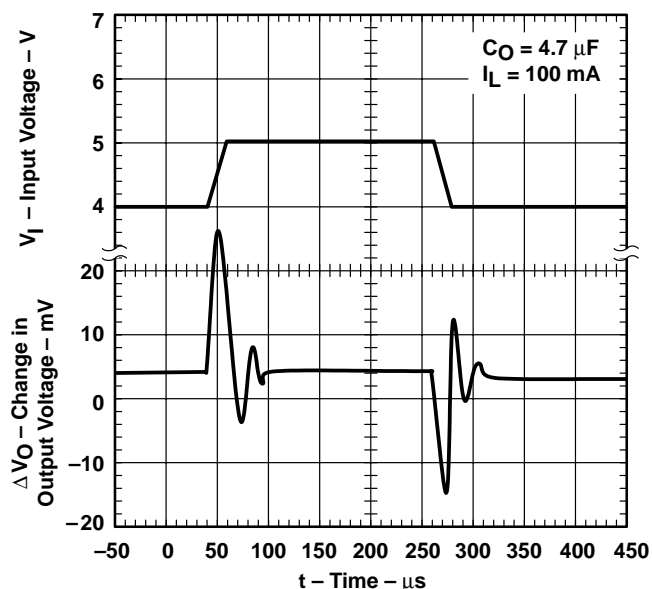

Figure 13

TPS76130
LOAD TRANSIENT RESPONSE

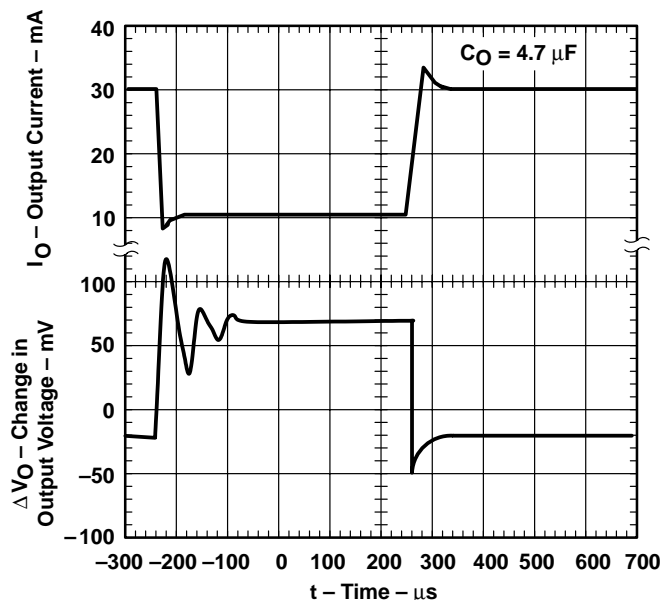

Figure 14

TPS76150
LINE TRANSIENT RESPONSE

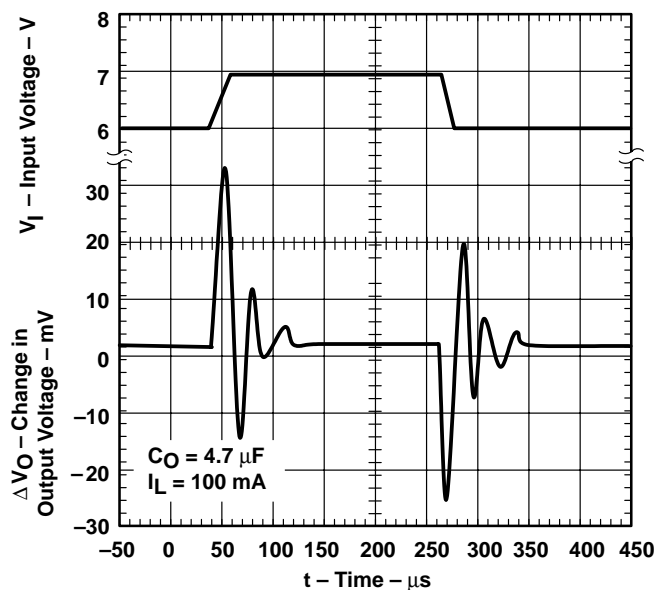

Figure 15

TPS76150
LOAD TRANSIENT RESPONSE

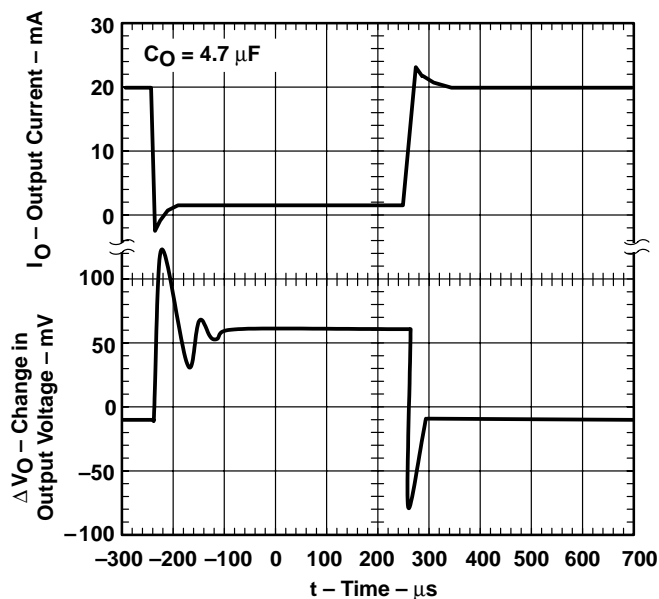

Figure 16



APPLICATION INFORMATION

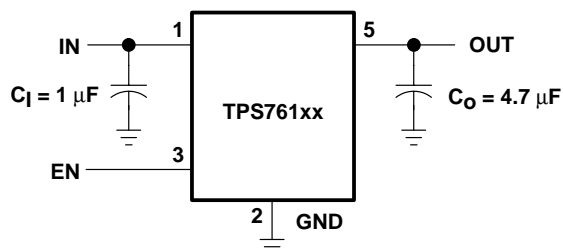

Figure 17. TPS761xx Typical Application

over current protection

The over current protection circuit forces the TPS761xx into a constant current output mode when the load is excessive or the output is shorted to ground. Normal operation resumes when the fault condition is removed.

NOTE:

An overload or short circuit may also activate the over temperature protection if the fault condition persists.

over temperature protection

The thermal protection system shuts the TPS761xx down when the junction temperature exceeds 160°C. The device recovers and operates normally when the temperature drops below 150°C.

input capacitor

A 1- μ F or larger ceramic decoupling capacitor with short leads connected between IN and GND is recommended. The decoupling capacitor may be omitted if there is a 1 μ F or larger electrolytic capacitor connected between IN and GND and located reasonably close to the TPS761xx. However, the small ceramic device is desirable even when the larger capacitor is present, if there is a lot of high frequency noise present in the system.

output capacitor

Like all low dropout regulators, the TPS761xx requires an output capacitor connected between OUT and GND to stabilize the internal control loop. The minimum recommended capacitance value is 4.7 μ F and the ESR (equivalent series resistance) must be between 0.1 Ω and 10 Ω . Solid tantalum electrolytic, aluminum electrolytic, and multilayer ceramic capacitors are all suitable, provided they meet the requirements described above. Most of the commercially available 4.7- μ F surface-mount solid-tantalum capacitors, including devices from Sprague, Kemet, and Nichicon, meet the ESR requirements stated above. Multilayer ceramic capacitors should have minimum values of 4.7 μ F over the full operating temperature range of the equipment.

enable (EN)

A logic zero on the enable input shuts the TPS761xx off and reduces the supply current to less than 1 μ A. Pulling the enable input high causes normal operation to resume. If the enable feature is not used, EN should be connected to IN to keep the regulator on all of the time. The EN input must not be left floating.

reverse current path

The power transistor used in the TPS761xx has an inherent diode connected between IN and OUT as shown in the functional block diagram. This diode conducts current from the OUT terminal to the IN terminal whenever IN is lower than OUT by a diode drop. This condition does not damage the TPS761xx provided the current is limited to 150 mA.

PACKAGING INFORMATION

Orderable part number	Status (1)	Material type (2)	Package Pins	Package qty Carrier	RoHS (3)	Lead finish/ Ball material (4)	MSL rating/ Peak reflow (5)	Op temp (°C)	Part marking (6)
TPS76130DBVR	Active	Production	SOT-23 (DBV) 5	3000 LARGE T&R	Yes	NIPDAU	Level-1-260C-UNLIM	-40 to 125	PAEI
TPS76130DBVR.A	Active	Production	SOT-23 (DBV) 5	3000 LARGE T&R	Yes	NIPDAU	Level-1-260C-UNLIM	-40 to 125	PAEI
TPS76130DBVT	NRND	Production	SOT-23 (DBV) 5	250 SMALL T&R	Yes	NIPDAU	Level-1-260C-UNLIM	-40 to 125	PAEI
TPS76130DBVT.A	NRND	Production	SOT-23 (DBV) 5	250 SMALL T&R	Yes	NIPDAU	Level-1-260C-UNLIM	-40 to 125	PAEI
TPS76132DBVR	Active	Production	SOT-23 (DBV) 5	3000 LARGE T&R	Yes	NIPDAU	Level-1-260C-UNLIM	-40 to 125	PAFI
TPS76132DBVR.A	Active	Production	SOT-23 (DBV) 5	3000 LARGE T&R	Yes	NIPDAU	Level-1-260C-UNLIM	-40 to 125	PAFI
TPS76132DBVT	Active	Production	SOT-23 (DBV) 5	250 SMALL T&R	Yes	NIPDAU	Level-1-260C-UNLIM	-40 to 125	PAFI
TPS76132DBVT.A	Active	Production	SOT-23 (DBV) 5	250 SMALL T&R	Yes	NIPDAU	Level-1-260C-UNLIM	-40 to 125	PAFI
TPS76133DBVR	Active	Production	SOT-23 (DBV) 5	3000 LARGE T&R	Yes	NIPDAU	Level-1-260C-UNLIM	-40 to 125	PAII
TPS76133DBVR.A	Active	Production	SOT-23 (DBV) 5	3000 LARGE T&R	Yes	NIPDAU	Level-1-260C-UNLIM	-40 to 125	PAII
TPS76133DBVT	Obsolete	Production	SOT-23 (DBV) 5	-	-	Call TI	Call TI	-40 to 125	PAII
TPS76138DBVR	Active	Production	SOT-23 (DBV) 5	3000 LARGE T&R	Yes	NIPDAU SN	Level-1-260C-UNLIM	-40 to 125	PAKI
TPS76138DBVR.A	Active	Production	SOT-23 (DBV) 5	3000 LARGE T&R	Yes	NIPDAU	Level-1-260C-UNLIM	-40 to 125	PAKI
TPS76138DBVT	Active	Production	SOT-23 (DBV) 5	250 SMALL T&R	Yes	NIPDAU SN	Level-1-260C-UNLIM	-40 to 125	PAKI
TPS76138DBVT.A	Active	Production	SOT-23 (DBV) 5	250 SMALL T&R	Yes	NIPDAU	Level-1-260C-UNLIM	-40 to 125	PAKI
TPS76150DBVR	NRND	Production	SOT-23 (DBV) 5	3000 LARGE T&R	Yes	NIPDAU	Level-1-260C-UNLIM	-40 to 125	PALI
TPS76150DBVR.A	NRND	Production	SOT-23 (DBV) 5	3000 LARGE T&R	Yes	NIPDAU	Level-1-260C-UNLIM	-40 to 125	PALI
TPS76150DBVRG4	Active	Production	SOT-23 (DBV) 5	3000 LARGE T&R	Yes	NIPDAU	Level-1-260C-UNLIM	-40 to 125	PALI
TPS76150DBVRG4.A	Active	Production	SOT-23 (DBV) 5	3000 LARGE T&R	Yes	NIPDAU	Level-1-260C-UNLIM	-40 to 125	PALI
TPS76150DBVT	Obsolete	Production	SOT-23 (DBV) 5	-	-	Call TI	Call TI	-40 to 125	PALI

(1) **Status:** For more details on status, see our [product life cycle](#).

(2) **Material type:** When designated, preproduction parts are prototypes/experimental devices, and are not yet approved or released for full production. Testing and final process, including without limitation quality assurance, reliability performance testing, and/or process qualification, may not yet be complete, and this item is subject to further changes or possible discontinuation. If available for ordering, purchases will be subject to an additional waiver at checkout, and are intended for early internal evaluation purposes only. These items are sold without warranties of any kind.

(3) **RoHS values:** Yes, No, RoHS Exempt. See the [TI RoHS Statement](#) for additional information and value definition.

(4) **Lead finish/Ball material:** Parts may have multiple material finish options. Finish options are separated by a vertical ruled line. Lead finish/Ball material values may wrap to two lines if the finish value exceeds the maximum column width.

(5) **MSL rating/Peak reflow:** The moisture sensitivity level ratings and peak solder (reflow) temperatures. In the event that a part has multiple moisture sensitivity ratings, only the lowest level per JEDEC standards is shown. Refer to the shipping label for the actual reflow temperature that will be used to mount the part to the printed circuit board.

(6) **Part marking:** There may be an additional marking, which relates to the logo, the lot trace code information, or the environmental category of the part.

Multiple part markings will be inside parentheses. Only one part marking contained in parentheses and separated by a "~" will appear on a part. If a line is indented then it is a continuation of the previous line and the two combined represent the entire part marking for that device.

Important Information and Disclaimer: The information provided on this page represents TI's knowledge and belief as of the date that it is provided. TI bases its knowledge and belief on information provided by third parties, and makes no representation or warranty as to the accuracy of such information. Efforts are underway to better integrate information from third parties. TI has taken and continues to take reasonable steps to provide representative and accurate information but may not have conducted destructive testing or chemical analysis on incoming materials and chemicals. TI and TI suppliers consider certain information to be proprietary, and thus CAS numbers and other limited information may not be available for release.

In no event shall TI's liability arising out of such information exceed the total purchase price of the TI part(s) at issue in this document sold by TI to Customer on an annual basis.

TAPE AND REEL INFORMATION

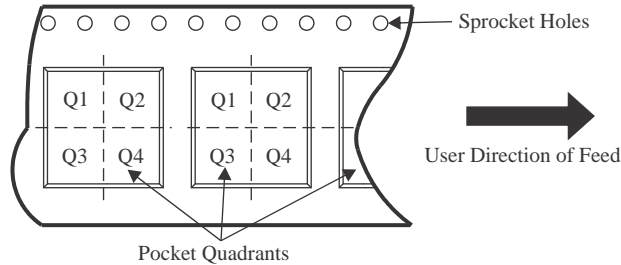
QUADRANT ASSIGNMENTS FOR PIN 1 ORIENTATION IN TAPE

*All dimensions are nominal

Device	Package Type	Package Drawing	Pins	SPQ	Reel Diameter (mm)	Reel Width W1 (mm)	A0 (mm)	B0 (mm)	K0 (mm)	P1 (mm)	W (mm)	Pin1 Quadrant
TPS76130DBVR	SOT-23	DBV	5	3000	180.0	9.0	3.15	3.2	1.4	4.0	8.0	Q3
TPS76130DBVT	SOT-23	DBV	5	250	180.0	9.0	3.15	3.2	1.4	4.0	8.0	Q3
TPS76132DBVR	SOT-23	DBV	5	3000	180.0	9.0	3.15	3.2	1.4	4.0	8.0	Q3
TPS76132DBVT	SOT-23	DBV	5	250	180.0	9.0	3.15	3.2	1.4	4.0	8.0	Q3
TPS76133DBVR	SOT-23	DBV	5	3000	180.0	9.0	3.15	3.2	1.4	4.0	8.0	Q3
TPS76138DBVR	SOT-23	DBV	5	3000	180.0	8.4	3.2	3.2	1.4	4.0	8.0	Q3
TPS76138DBVT	SOT-23	DBV	5	250	180.0	8.4	3.2	3.2	1.4	4.0	8.0	Q3
TPS76150DBVR	SOT-23	DBV	5	3000	180.0	8.4	3.2	3.2	1.4	4.0	8.0	Q3
TPS76150DBVT	SOT-23	DBV	5	3000	180.0	8.4	3.2	3.2	1.4	4.0	8.0	Q3
TPS76150DBVRG4	SOT-23	DBV	5	3000	180.0	8.4	3.2	3.2	1.4	4.0	8.0	Q3

TAPE AND REEL BOX DIMENSIONS

*All dimensions are nominal

Device	Package Type	Package Drawing	Pins	SPQ	Length (mm)	Width (mm)	Height (mm)
TPS76130DBVR	SOT-23	DBV	5	3000	182.0	182.0	20.0
TPS76130DBVT	SOT-23	DBV	5	250	182.0	182.0	20.0
TPS76132DBVR	SOT-23	DBV	5	3000	182.0	182.0	20.0
TPS76132DBVT	SOT-23	DBV	5	250	182.0	182.0	20.0
TPS76133DBVR	SOT-23	DBV	5	3000	182.0	182.0	20.0
TPS76138DBVR	SOT-23	DBV	5	3000	210.0	185.0	35.0
TPS76138DBVT	SOT-23	DBV	5	250	210.0	185.0	35.0
TPS76150DBVR	SOT-23	DBV	5	3000	210.0	185.0	35.0
TPS76150DBVR	SOT-23	DBV	5	3000	210.0	185.0	35.0
TPS76150DBVRG4	SOT-23	DBV	5	3000	210.0	185.0	35.0

EXAMPLE BOARD LAYOUT

DBV0005A

SOT-23 - 1.45 mm max height

SMALL OUTLINE TRANSISTOR



LAND PATTERN EXAMPLE
EXPOSED METAL SHOWN
SCALE:15X



SOLDER MASK DETAILS

4214839/K 08/2024

NOTES: (continued)

- 6. Publication IPC-7351 may have alternate designs.
- 7. Solder mask tolerances between and around signal pads can vary based on board fabrication site.

EXAMPLE STENCIL DESIGN

DBV0005A

SOT-23 - 1.45 mm max height

SMALL OUTLINE TRANSISTOR



SOLDER PASTE EXAMPLE
BASED ON 0.125 mm THICK STENCIL
SCALE:15X

4214839/K 08/2024

NOTES: (continued)

8. Laser cutting apertures with trapezoidal walls and rounded corners may offer better paste release. IPC-7525 may have alternate design recommendations.
9. Board assembly site may have different recommendations for stencil design.

IMPORTANT NOTICE AND DISCLAIMER

TI PROVIDES TECHNICAL AND RELIABILITY DATA (INCLUDING DATASHEETS), DESIGN RESOURCES (INCLUDING REFERENCE DESIGNS), APPLICATION OR OTHER DESIGN ADVICE, WEB TOOLS, SAFETY INFORMATION, AND OTHER RESOURCES "AS IS" AND WITH ALL FAULTS, AND DISCLAIMS ALL WARRANTIES, EXPRESS AND IMPLIED, INCLUDING WITHOUT LIMITATION ANY IMPLIED WARRANTIES OF MERCHANTABILITY, FITNESS FOR A PARTICULAR PURPOSE OR NON-INFRINGEMENT OF THIRD PARTY INTELLECTUAL PROPERTY RIGHTS.

These resources are intended for skilled developers designing with TI products. You are solely responsible for (1) selecting the appropriate TI products for your application, (2) designing, validating and testing your application, and (3) ensuring your application meets applicable standards, and any other safety, security, regulatory or other requirements.

These resources are subject to change without notice. TI grants you permission to use these resources only for development of an application that uses the TI products described in the resource. Other reproduction and display of these resources is prohibited. No license is granted to any other TI intellectual property right or to any third party intellectual property right. TI disclaims responsibility for, and you fully indemnify TI and its representatives against any claims, damages, costs, losses, and liabilities arising out of your use of these resources.

TI's products are provided subject to [TI's Terms of Sale](#), [TI's General Quality Guidelines](#), or other applicable terms available either on ti.com or provided in conjunction with such TI products. TI's provision of these resources does not expand or otherwise alter TI's applicable warranties or warranty disclaimers for TI products. Unless TI explicitly designates a product as custom or customer-specified, TI products are standard, catalog, general purpose devices.

TI objects to and rejects any additional or different terms you may propose.

Copyright © 2026, Texas Instruments Incorporated

Last updated 10/2025