

TPSM8310xx 1.5A Output Current, Buck-Boost MicroSiP™ Power Module With Integrated Inductor

1 Features

- 1.6V to 5.5V input voltage range
 - Device input voltage > 1.65V for start-up
- 1.2V to 5.5V output voltage range
 - 1.0V V_{OUT} is supported in PFM mode
- High output current capability, 3A peak switch current
 - 1.5A I_{OUT} for $V_{IN} \geq 3V$, $V_{OUT} = 3.3V$
 - 1.2A I_{OUT} for $V_{IN} \geq 2.7V$, $V_{OUT} = 3.3V$
- Active output discharge (TPSM83101, TPSM83101L only)
- High efficiency over the entire load range
 - 8 μ A typical quiescent current
 - Automatic power save mode and forced PWM mode
- Peak current buck-boost mode architecture
 - Seamless mode transition
 - Forward and reverse current operation
 - Start-up into prebiased outputs
 - Fixed-frequency operation with 2MHz switching
- Safety and robust operation features
 - Overcurrent protection and short-circuit protection
 - Integrated soft start with active ramp adoption
 - Overtemperature protection and overvoltage protection
 - True shutdown function with load disconnection
 - Forward and backward current limit
- Small design size
 - MicroSiP™ power module with integrated inductor
 - 2.0mm × 2.6mm × 1.2mm(max) 8-pin μ SiP package
- Create a custom design using the TPSM8310xx device with the [WEBENCH® Power Designer](#)

2 Applications

- Voltage stabilizer (datacom, [optical modules](#), cooling/heating)
- System pre-regulator ([smartphone](#), [tablet](#), terminal, [telematics](#))
- Point-of-load regulation (wired sensor, [port/cable adapter](#), and [dongle](#))
- Fingerprint, camera sensors ([electronic smart lock](#), [IP network camera](#))

3 Description

The TPSM83100, TPSM83101, and TPSM83101L are constant frequency peak current mode control buck-boost MicroSiP™ power modules optimized for small design size and high efficiency. The power modules integrate an inductor to simplify design, reduce external components, and save PCB area. The power modules have a 3A peak current limit (typical) and 1.6V to 5.5V input voltage range. The TPSM83100 and TPSM83101, TPSM83101L provide a power supply design for system pre-regulators and voltage stabilizers.

Depending on the input voltage, the TPSM83100 and TPSM83101, TPSM83101L automatically operate in boost, buck, or in 3-cycle buck-boost mode when the input voltage is approximately equal to the output voltage. The transitions between modes happen at a defined duty cycle and avoid unwanted toggling within the modes to reduce output voltage ripple. 8 μ A quiescent current and power save mode enable the highest efficiency for light to no-load conditions.

Device Information

PART NUMBER ⁽³⁾	PACKAGE ⁽¹⁾	PACKAGE SIZE ⁽²⁾
TPSM83100	SIU (μ SiP, 8)	2.6mm × 2mm
TPSM83101, TPSM83101L		

- (1) For more information, see [Section 11](#).
- (2) The package size (length × width) is a nominal value and includes pins, where applicable.
- (3) See the [Device Comparison Table](#).

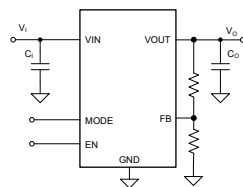

Typical Application

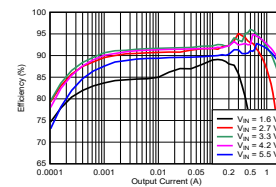

Efficiency vs Output Current ($V_{OUT} = 3.3V$)



Table of Contents

1 Features	1	8 Application and Implementation	10
2 Applications	1	8.1 Application Information.....	10
3 Description	1	8.2 Typical Application.....	10
4 Device Comparison Table	3	8.3 Power Supply Recommendations.....	17
5 Pin Configuration and Functions	3	8.4 Layout.....	17
6 Specifications	4	9 Device and Documentation Support	18
6.1 Absolute Maximum Ratings.....	4	9.1 Device Support	18
6.2 ESD Rating.....	4	9.2 Receiving Notification of Documentation Updates... 18	
6.3 Recommended Operating Conditions.....	4	9.3 Support Resources.....	18
6.4 Thermal Information.....	4	9.4 Trademarks.....	18
6.5 Electrical Characteristics	5	9.5 Electrostatic Discharge Caution.....	18
7 Detailed Description	6	9.6 Glossary.....	19
7.1 Overview.....	6	10 Revision History	19
7.2 Functional Block Diagram.....	6	11 Mechanical, Packaging, and Orderable	
7.3 Feature Description	6	Information	20
7.4 Device Functional Modes.....	9		

4 Device Comparison Table

PART NUMBER	OUTPUT DISCHARGE	FAST_RAMP
TPSM83100	No	Enabled
TPSM83101	Yes	Enabled
TPSM83101L	Yes	Disabled

5 Pin Configuration and Functions

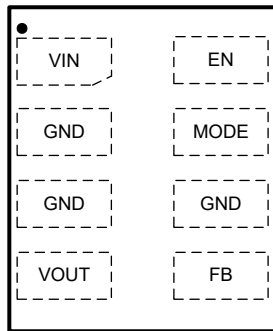

Figure 5-1. 8-Pin μ SiP Package (Top View)

Table 5-1. Pin Functions

PIN		TYPE ⁽¹⁾	DESCRIPTION
NAME	NO.		
VIN	1	PWR	Supply input voltage
GND	2	PWR	Power ground
GND	3	PWR	Power ground
VOUT	4	PWR	Power stage output
FB	5	I	Voltage feedback. Sensing pin
GND	6	PWR	Power ground
MODE	7	I	PFM/PWM selection. Set low for power save mode, set high for forced PWM. this pin must not be left floating.
EN	8	I	Device enable. Set high to enable and low to disable. This pin must not be left floating.

(1) PWR = power, I = input

6 Specifications

6.1 Absolute Maximum Ratings

over operating junction temperature range (unless otherwise noted)⁽¹⁾

		MIN	MAX	UNIT
V_I	Input voltage (VIN, VOUT, EN, FB, MODE) ⁽²⁾	-0.3	6.0	V
V_I	Input voltage for less than 10 ns	-0.3	7.0	V
T_J	Operating junction temperature	-40	150	°C
T_{stg}	Storage temperature	-65	150	°C

- (1) Operation outside the Absolute Maximum Ratings may cause permanent device damage. Absolute Maximum Ratings do not imply functional operation of the device at these or any other conditions beyond those listed under Recommended Operating Conditions. If used outside the Recommended Operating Conditions but within the Absolute Maximum Ratings, the device may not be fully functional, and this may affect device reliability, functionality, performance, and shorten the device lifetime.
- (2) All voltage values are with respect to network ground terminal, unless otherwise noted.

6.2 ESD Rating

			VALUE	UNIT
$V_{(ESD)}$	Electrostatic discharge	Human-body model (HBM), per ANSI/ESDA/JEDEC JS-001 ⁽¹⁾	±1000	V
		Charged-device model (CDM), per ANSI/ESDA/JEDEC JS-002 ⁽²⁾	± 500	

- (1) JEDEC document JEP155 states that 500-V HBM allows safe manufacturing with a standard ESD control process.
- (2) JEDEC document JEP157 states that 250-V CDM allows safe manufacturing with a standard ESD control process.

6.3 Recommended Operating Conditions

over operating junction temperature (unless otherwise noted)

			MIN	NOM	MAX	UNIT
V_I	Supply voltage		1.6		5.5	V
V_O	Output voltage		1.2		5.5	V
C_I	Input effective capacitance	$V_I = 1.6\text{ V to }5.5\text{ V}$	4.2			μF
C_O	Output effective capacitance	$1.2\text{ V} \leq V_O \leq 3.6\text{ V}$, nominal value at $V_O = 3.3\text{ V}$	10.4	16.9	330	μF
		$3.6\text{ V} < V_O \leq 5.5\text{ V}$, nominal value at $V_O = 5\text{ V}$	7.95	10.6	330	μF
T_J	Operating junction temperature range		-40		125	°C

6.4 Thermal Information

over operating free-air temperature range (unless otherwise noted)

THERMAL METRIC ⁽¹⁾		TPSM83100 TPSM83101 TPSM83101L	TPSM83100 TPSM83101 TPSM83101L	UNIT
		μSiP-8 PINS	μSiP-8 PINS	
		Standard	EVM	
$R_{\theta JA}$	Junction-to-ambient thermal resistance	100	48.9	°C/W
$R_{\theta JC(top)}$	Junction-to-case (top) thermal resistance	42.2	N/A	°C/W
$R_{\theta JB}$	Junction-to-board thermal resistance	33.2	N/A	°C/W
Ψ_{JT}	Junction-to-top characterization parameter	N/A	N/A	°C/W
Ψ_{JB}	Junction-to-board characterization parameter	32.2	24.5	°C/W

- (1) For more information about traditional and new thermal metrics, see the [Semiconductor and IC Package Thermal Metrics](#) application report.

6.5 Electrical Characteristics

Over operating junction temperature range and recommended supply voltage range (unless otherwise noted). Typical values are at $V_I = 3.8\text{ V}$, $V_O = 3.3\text{ V}$ and $T_J = 25^\circ\text{C}$ (unless otherwise noted).

PARAMETER		TEST CONDITIONS		MIN	TYP	MAX	UNIT	
SUPPLY								
I_{SD}	Shutdown current into VIN	$V_I = 3.8\text{ V}$, $V_{(EN)} = 0\text{ V}$	$T_J = 25^\circ\text{C}$		0.5	0.9	μA	
I_Q	Quiescent current into VIN	$V_I = 2.2\text{ V}$, $V_O = 3.3\text{ V}$, $V_{(EN)} = 2.2\text{ V}$, no switching			0.15	6.1	μA	
I_Q	Quiescent current into VOUT	$V_I = 2.2\text{ V}$, $V_O = 3.3\text{ V}$, $V_{(EN)} = 2.2\text{ V}$, no switching			8		μA	
V_{IT+}	Positive-going UVLO threshold voltage			1.5	1.55	1.599	V	
V_{IT-}	Negative-going UVLO threshold voltage	During start-up		1.4	1.45	1.499	V	
V_{hys}	UVLO threshold voltage hysteresis			99			mV	
$V_{I(POR)T+}$	Positive-going POR threshold voltage	maximum of V_I or V_O		1.25	1.45	1.65	V	
$V_{I(POR)T-}$	Negative-going POR threshold voltage			1.22	1.43	1.6	V	
I/O SIGNALS								
V_{T+}	Positive-going threshold voltage	EN, MODE		0.77	0.98	1.2	V	
V_{T-}	Negative-going threshold voltage	EN, MODE		0.5	0.66	0.76	V	
V_{hys}	Hysteresis voltage	EN, MODE			300		mV	
I_{IH}	High-level input current	EN, MODE	$V_{(EN)} = V_{(MODE)} = 1.5\text{ V}$, no pullup resistor		± 0.01	± 0.25	μA	
I_{IL}	Low-level input current	EN, MODE	$V_{(EN)} = V_{(MODE)} = 0\text{ V}$		± 0.01	± 0.1	μA	
	Input bias current	EN, MODE	$V_{(EN)} = 5.5\text{ V}$		± 0.01	± 0.3	μA	
POWER SWITCH								
$r_{DS(on)}$	On-state resistance	Q1	$V_I = 3.8\text{ V}$, $V_O = 3.3\text{ V}$, test current = 0.2 A		45		m Ω	
		Q2			50		m Ω	
		Q3			50		m Ω	
		Q4			85		m Ω	
CURRENT LIMIT								
$I_{L(PEAK)}$	Switch peak current limit ⁽¹⁾	Q1	$V_O = 3.3\text{ V}$	Output sourcing current	2.6	3	3.35	A
				Output sinking current, $V_I = 3.3\text{ V}$	-0.7	-0.55	-0.45	A
	PFM mode entry threshold (peak) current ⁽¹⁾		I_O falling			145		mA
OUTPUT								
I_{DIS}	TPSM83101/TPSM83101L output discharge current		EN = LOW, $V_I = 2.2\text{ V}$ $V_O = 3.3\text{ V}$		-67			mA
V_{FB}	Reference voltage on feedback pin			495	500	505		mV
PROTECTION FEATURES								
$V_{T+(OVP)}$	Positive-going OVP threshold voltage			5.55	5.75	5.95		V
$V_{T+(IVP)}$	Positive-going IVP threshold voltage			5.55	5.75	5.95		V
T_{JT+}	Thermal shutdown threshold temperature		T_J rising		160			$^\circ\text{C}$
	Thermal shutdown hysteresis				25			$^\circ\text{C}$
TIMING PARAMETERS								
$t_{d(EN)}$	Delay between a rising edge on the EN pin and the start of the output voltage ramp				0.87	1.5		ms
$t_{d(ramp)}$	Soft-start ramp time			6.42	7.55	8.68		ms
f_{SW}	Switching frequency			1.8	2	2.2		MHz

(1) Current limit production test are performed under DC conditions. The current limit in operation is somewhat higher and depends on propagation delay and the applied external components

7 Detailed Description

7.1 Overview

The TPSM83100, TPSM83101, and TPSM83101L are constant frequency peak current mode control buck-boost MicroSiP™ power modules. The modules use a fixed-frequency topology with approximately 2MHz switching frequency. The modulation scheme has three clearly defined operation modes where the modules enter with defined thresholds over the full operation range of V_{IN} and V_{OUT} . The maximum output current is determined by the Q1 peak current limit which is typically 3A and by the thermal limitation.

7.2 Functional Block Diagram

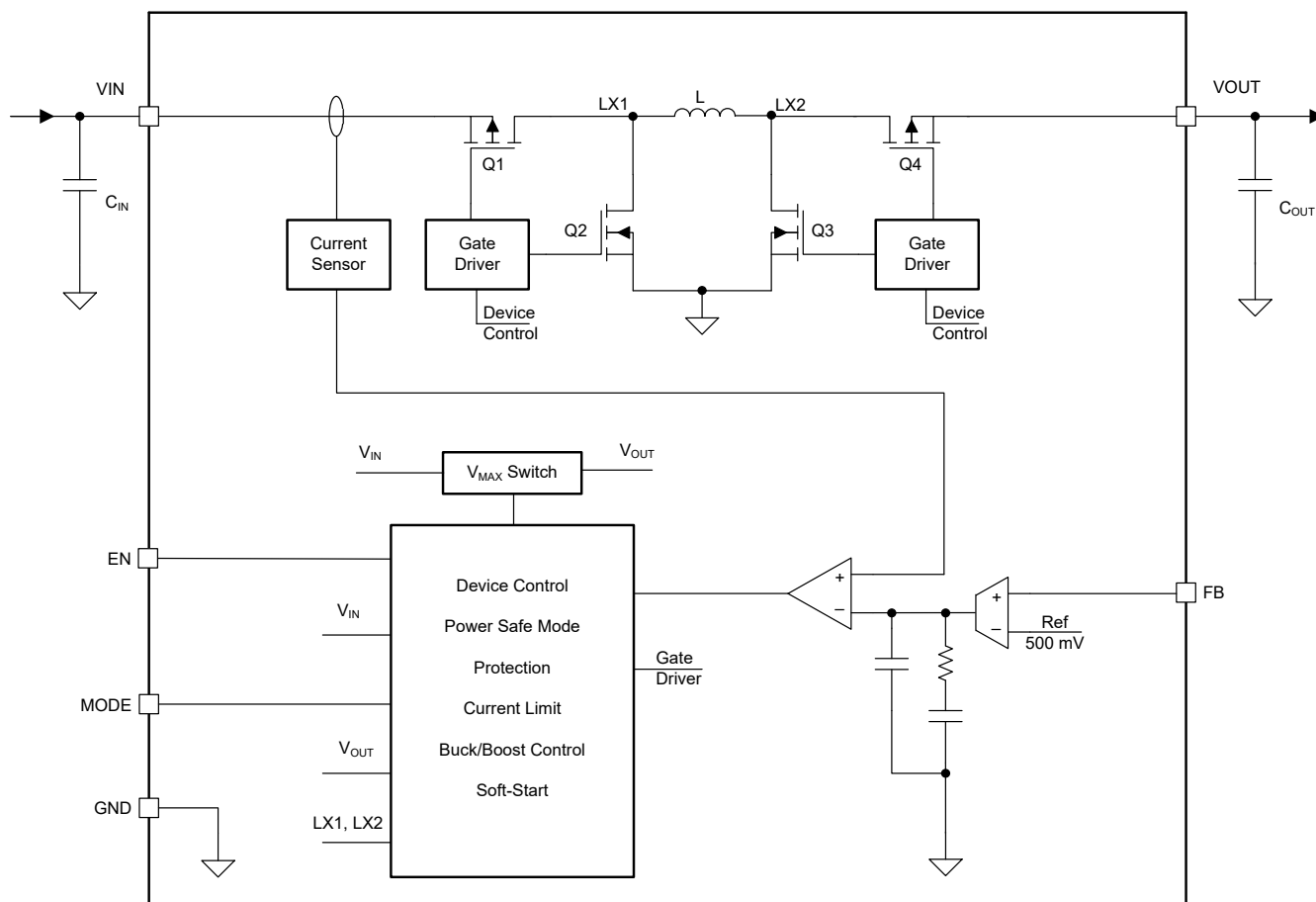

7.3 Feature Description

7.3.1 Undervoltage Lockout (UVLO)

The input voltage of the V_{IN} pin is continuously monitored if the device is not in shutdown mode. UVLO only stops or starts the module operation. The UVLO does not impact the core logic of the device. UVLO avoids a brownout of the device during device operation. In case the supply voltage on the V_{IN} pin is lower than the negative-going threshold of UVLO, the module stops the operation. To avoid a false disturbance of the power conversion, the UVLO falling threshold logic signal is digitally deglitched.

If the supply voltage on the V_{IN} pin recovers to be higher than the UVLO rising threshold, the module returns to operation. In this case, the soft-start procedure restarts faster than under start-up without a prebiased output.

7.3.2 Enable and Soft Start

When the input voltage is above the UVLO rising threshold and the EN pin is pulled to a voltage above 1.2V, the TPSM83100, TPSM83101, and TPSM83101L are enabled and start up after a short delay time, $t_{d(EN)}$.

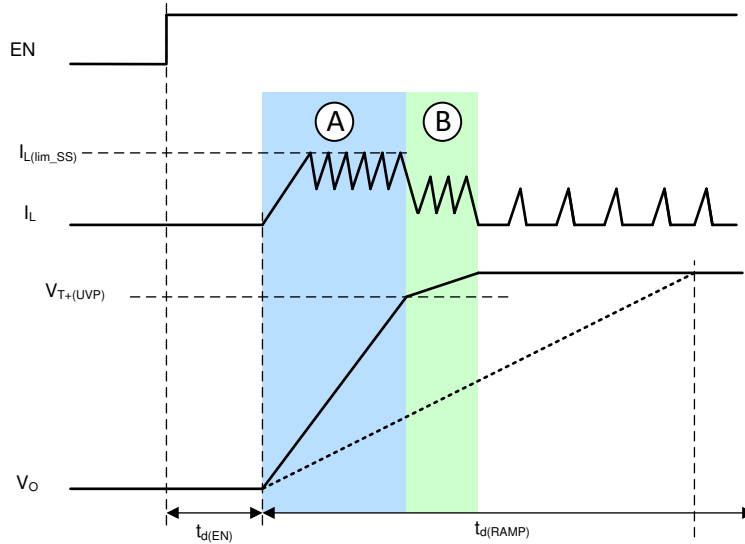

Figure 7-1. TPSM83100 and TPSM83101 Typical Soft-Start Behavior(FAST_RAMP Enabled)

The TPSM83100 and TPSM83101 have an inductor peak current clamp to limit inrush current during start-up. When the minimum current clamp ($I_{L(lim_SS)}$) is lower than the current that is necessary to follow the voltage ramp, the current automatically increases to follow the voltage ramp. The minimum current limit ensures as fast as possible soft start if the capacitance is chosen lower than what the ramp time $t_{d(RAMP)}$ was selected for.

In a typical start-up case as shown in Figure 7-1 (low output load, typical output capacitance), the minimum current clamp limits the inrush current and charges the output capacitor. The output voltage then rises faster than the reference voltage ramp (see phase A in Figure 7-1). To avoid an output overshoot, the current clamp is deactivated when the output is close to the target voltage and follows the reference voltage ramp slew value given by the voltage ramp, which is finishing the start up (see phase B in Figure 7-1). The transition from the minimum current clamp operation is sensed by using the threshold $V_{T+(UVP)}$. After phase B, the output voltage is well regulated to the nominal target voltage. The current waveform depends on the output load and operation mode.

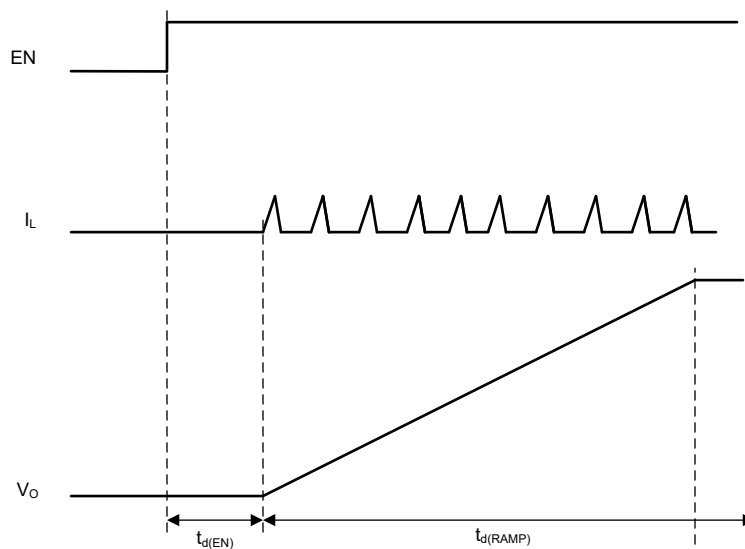

Figure 7-2. TPSM83101L Typical Soft-Start Behavior(FAST_RAMP Disabled)

Figure 7-2 shows the TPSM83101L typical start-up behavior (low output load, typical output capacitance). After the short delay time $t_{d(EN)}$, the device starts to ramp up the output voltage by ramping an internal reference

voltage from 0V to the reference voltage within typical 7.55mS $t_{d(\text{ramp})}$. For applications that requires less inrush current, TPSM83101L can be used.

7.3.3 Adjustable Output Voltage

The output voltage is set by an external resistor divider. The resistor divider must be connected between VOUT, FB, and GND. The feedback voltage is given by V_{FB} . The recommended low-side resistor R2 (between FB and GND) is below 100k Ω . The high-side resistor R1 (between FB and VOUT) is calculated by [Equation 1](#).

$$R1 = R2 \times (V_{OUT} / V_{FB} - 1) \quad (1)$$

The typical V_{FB} voltage is 0.5 V.

7.3.4 Mode Selection (PFM/FPWM)

The mode pin is a digital input to enable PFM/FPWM.

When the MODE pin is connected to logic low, the device works in auto PFM mode. The device features a power save mode to maintain the highest efficiency over the full operating output current range. PFM automatically changes the converter operation from CCM to pulse frequency modulation.

When the MODE pin is connected to logic high, the device works in forced PWM mode, regardless of the output current, to achieve minimum output ripple.

7.3.5 Output Discharge

TPSM83101/TPSM83101L provides an active pull down current(67mA typ) to quickly discharge output when the EN is logic low. With this function, the VOUT is connected to ground through internal circuitry, preventing the output from “floating” or entering into an undetermined state. The output discharge function makes the power on and off sequencing smooth. Pay attention to the output discharge function if use this device in applications such as power multiplexing, because the output discharge circuitry creates a constant current path between the multiplexer output and the ground.

7.3.6 Reverse Current Operation

The device can support reverse current operation (the current flows from VOUT pin to VIN pin) in FPWM mode. If the output feedback voltage on the FB pin is higher than the reference voltage, the module regulation forces a current into the input capacitor. The reverse current operation is independent of the V_{IN} voltage or V_{OUT} voltage ratio, hence the reverse current operation is possible on all device operation modes boost, buck, or buck-boost.

7.3.7 Protection Features

The following sections describe the protection features of the device.

7.3.7.1 Input Overvoltage Protection

The TPSM83100, TPSM83101, and TPSM83101L have input overvoltage protection which avoids any damage to the device in case the current flows from the output to the input and the input source cannot sink current (for example, a diode in the supply path).

If forced PWM mode is active, the current can go negative until reaching the sink current limit. After the input voltage threshold, $V_{T+(IVP)}$, is reached on the VIN pin, the protection disables forced PWM mode and only allows current to flow from VIN to VOUT. After the input voltage drops under the input voltage protection threshold, forced PWM mode can be activated again.

7.3.7.2 Output Overvoltage Protection

The TPSM83100, TPSM83101, and TPSM83101L have the output overvoltage protection which avoids any damage to the device in case the external feedback pin is not working properly.

When the output voltage threshold $V_{T+(OVP)}$ is reached at the VOUT pin, the protection disables the module power stage and makes the switching nodes high impedance.

7.3.7.3 Short Circuit Protection

The device features peak current limit performance at short circuit protection. Figure 7-3 shows a typical device behavior of an short/overload event of the short circuit protection.

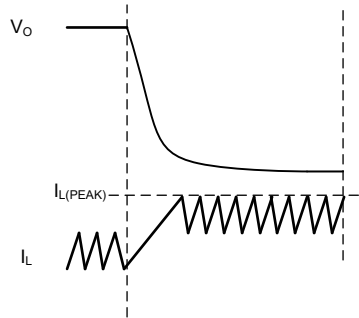

Figure 7-3. Typical Device Behavior During Short Circuit Protection

7.3.7.4 Thermal Shutdown

To avoid thermal damage of the device, the temperature of the die is monitored. The device stops operation once the sensed temperature rises over the typical thermal threshold 160 °C. After the temperature drops below the typical thermal shutdown hysteresis 25 °C, the module returns to normal operation.

7.4 Device Functional Modes

The device has two functional modes: off and on. The device enters the on mode when the voltage on the VIN pin is higher than the UVLO threshold and a high logic level is applied to the EN pin. The device enters the off mode when the voltage on the VIN pin is lower than the UVLO threshold or a low logic level is applied to the EN pin.

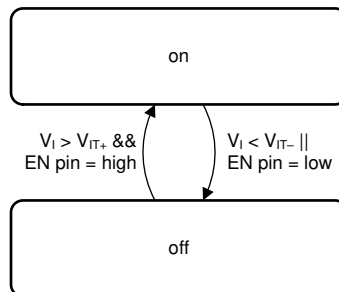

Figure 7-4. Device Functional Modes

8 Application and Implementation

Note

Information in the following applications sections is not part of the TI component specification, and TI does not warrant its accuracy or completeness. TI's customers are responsible for determining suitability of components for their purposes, as well as validating and testing their design implementation to confirm system functionality.

8.1 Application Information

The TPSM83100, TPSM83101, and TPSM83101L are high-efficiency, low-quiescent current, buck-boost modules. The devices are designed for applications needing a regulated output voltage from an input supply that can be higher or lower than the output voltage.

8.2 Typical Application

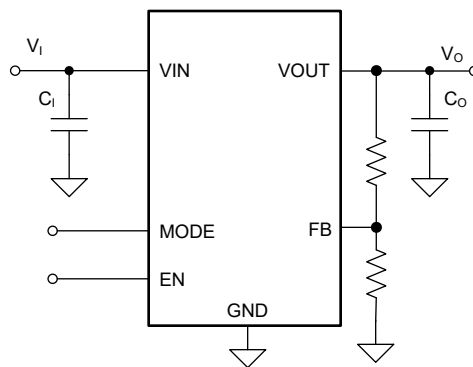

Figure 8-1. 3.3V_{OUT} Typical Application

8.2.1 Design Requirements

The design parameters are listed in [Table 8-1](#).

Table 8-1. Design Parameters

PARAMETERS	VALUES
Input voltage	2.7V to 4.3V
Output voltage	3.3V
Output current	1.5A

8.2.2 Detailed Design Procedure

The first step is the selection of the output filter components. To simplify this process, *Recommended Operating Conditions* outlines minimum and maximum values for capacitance. Pay attention to the tolerance and derating when selecting nominal capacitance.

8.2.2.1 Custom Design With WEBENCH® Tools

The TPSM83100, TPSM83101, and TPSM83101L reuse the WEBENCH® Power Designer of the TPS631010 ([click here](#)) and TPS631011 ([click here](#)).

1. Start by entering your V_{IN} , V_{OUT} and I_{OUT} requirements.
2. Optimize your design for key parameters like efficiency, footprint or cost using the optimizer dial and compare this design with other possible solutions from Texas Instruments.
3. WEBENCH Power Designer provides you with a customized schematic along with a list of materials with real time pricing and component availability.

The WEBENCH Power Designer provides you with a customized schematic along with a list of materials with real time pricing and component availability.

In most cases, these actions are available:

- Run electrical simulations to see important waveforms and circuit performance,
- Run thermal simulations to understand the thermal performance of your board,
- Export your customized schematic and layout into popular CAD formats,
- Print PDF reports for the design, and share your design with colleagues.

Get more information about WEBENCH tools at www.ti.com/WEBENCH.

8.2.2.2 Output Capacitor Selection

For the output capacitor, use small ceramic capacitors placed as close as possible to the VOUT and PGND pins of the module. The recommended total nominal output capacitor value is 47 µF. If, for any reason, the application requires the use of large capacitors that cannot be placed close to the module, use a smaller ceramic capacitor in parallel to the large capacitor, and place the small capacitor as close as possible to the VOUT and PGND pins of the module.

Make sure that the effective capacitance is given according to the recommended value in *Recommended Operating Conditions*. In general, consider DC bias effects resulting in less effective capacitance. The choice of the output capacitance is mainly a tradeoff between size and transient behavior as higher capacitance reduces transient response over, undershoot and increases transient response time. Possible output capacitors are listed in [Table 8-2](#).

Table 8-2. List of Recommended Capacitors

CAPACITOR VALUE [µF]	VOLTAGE RATING [V]	ESR [mΩ]	PART NUMBER	MANUFACTURER ⁽¹⁾	SIZE (METRIC)
47	6.3	10	GRM219R60J476ME44	Murata	0805 (2012)
47	10	40	CL10A476MQ8QRN	Semco	0603 (1608)

(1) See the [Third-Party Products Disclaimer](#).

8.2.2.3 Input Capacitor Selection

A 22-µF input capacitor is recommended to improve line transient behavior of the regulator and EMI behavior of the total power supply circuit. An X5R or X7R ceramic capacitor placed as close as possible to the VIN and PGND pins of the module is recommended. This capacitance can be increased without limit. If the input supply is located more than a few inches from the TPSM83100, additional bulk capacitance can be required in addition to the ceramic bypass capacitors. An electrolytic or tantalum capacitor with a value of 47 µF is a typical choice.

Table 8-3. List of Recommended Capacitors

CAPACITOR VALUE [µF]	VOLTAGE RATING [V]	ESR [mΩ]	PART NUMBER	MANUFACTURER ⁽¹⁾	SIZE (METRIC)
22	6.3	43	GRM187R61A226ME15	Murata	0603 (1608)
10	10	40	GRM188R61A106ME69	Murata	0603 (1608)

(1) See the [Section 9.1.1](#).

8.2.2.4 Setting the Output Voltage

The output voltage is set by an external resistor divider. The resistor divider must be connected between VOUT, FB, and GND. The feedback voltage is 500mV nominal.

Keep the low-side resistor R2 (between FB and GND) below 100kΩ. The high-side resistor (between FB and VOUT) R1 is calculated with [Equation 2](#).

$$R1 = R2 \times \left(\frac{V_{OUT}}{V_{FB}} - 1 \right) \tag{2}$$

where $V_{FB} = 500\text{mV}$.

Table 8-4. Resistor Selection For Typical Output Voltages

V_{OUT}	R1	R2
2.5V	365K	91K
3.3V	511K	91K
3.6V	562K	91K
5.0V	806K	91K

8.2.3 Application Curves

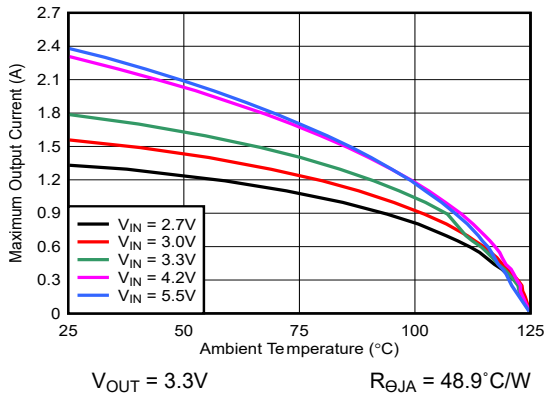

Figure 8-2. Safe Operating Area Based on Thermal Limitation

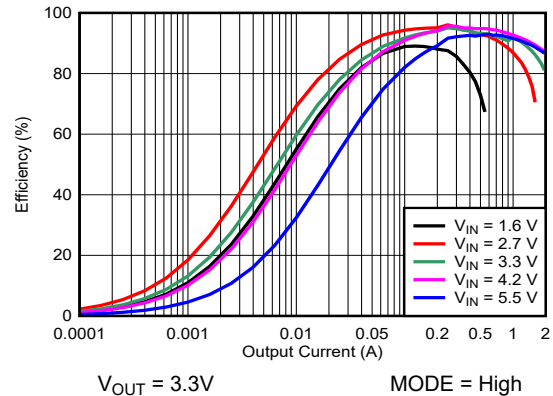

Figure 8-3. Efficiency vs Output Current (FPWM)

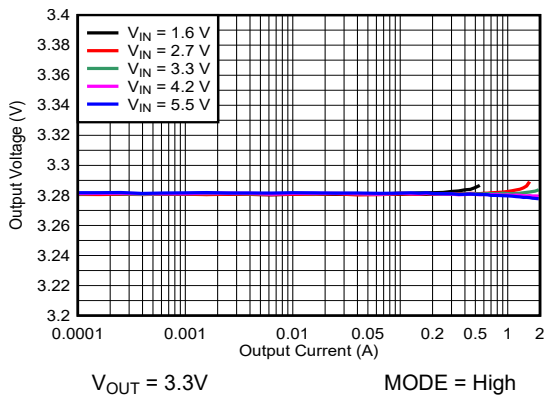

Figure 8-4. Load Regulation (FPWM)

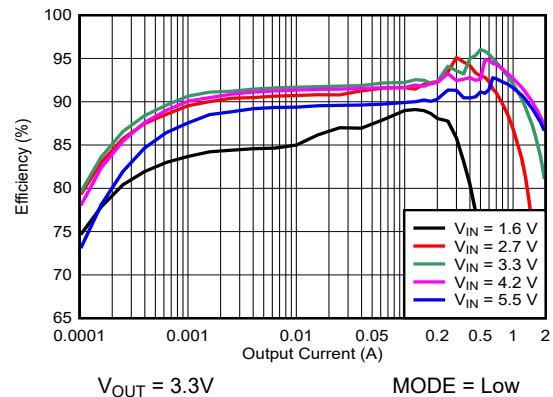

Figure 8-5. Efficiency vs Input Voltage (PFM)

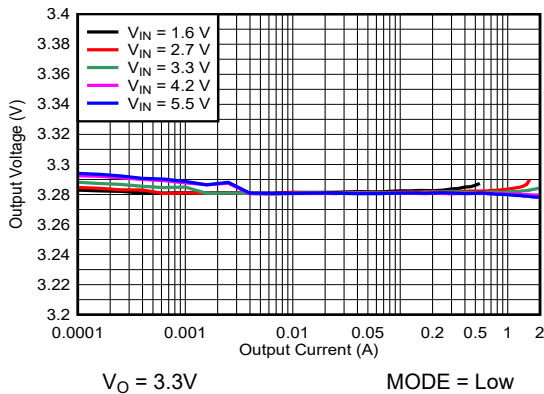

Figure 8-6. Load Regulation (PFM)

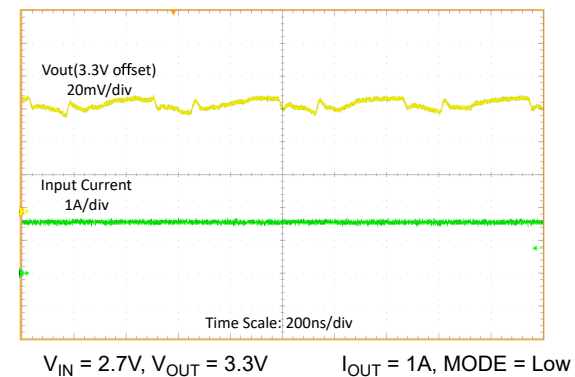
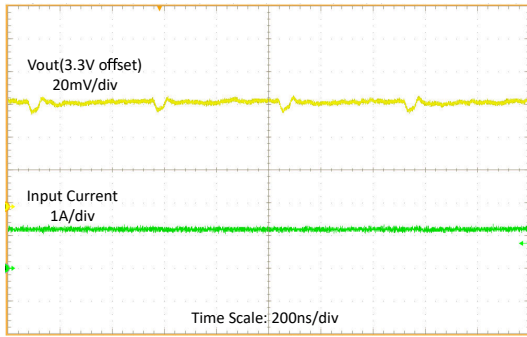
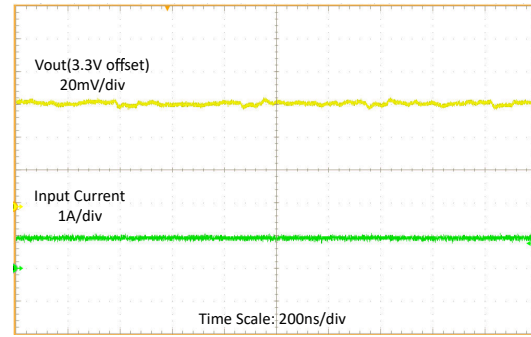

Figure 8-7. Steady State Waveforms, Boost Operation with 1A Load



$V_{IN} = 3.3V, V_{OUT} = 3.3V \quad I_{OUT} = 1A, \text{MODE} = \text{Low}$

Figure 8-8. Steady State Waveforms, Buck-Boost with 1A Load



$V_{IN} = 4.3V, V_{OUT} = 3.3V \quad I_{OUT} = 1A, \text{MODE} = \text{Low}$

Figure 8-9. Steady State Waveforms, Buck Operation with 1A Load

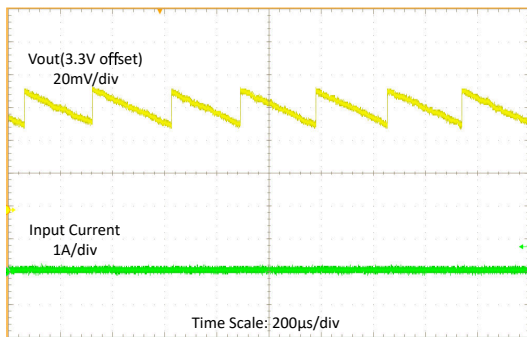

$V_{IN} = 3.6V, V_{OUT} = 3.3V \quad I_{OUT} = 1mA, \text{MODE} = \text{Low}$

Figure 8-10. Steady State Waveforms, with 1mA Load

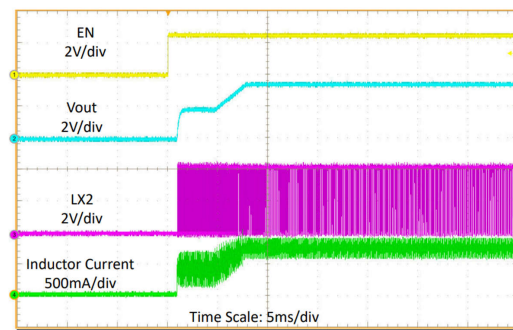

$V_{IN} = 3.6V, V_{OUT} = 3.3V \quad R_{load} = 4\Omega, \text{MODE} = \text{Low}$

Figure 8-11. Start-Up by EN

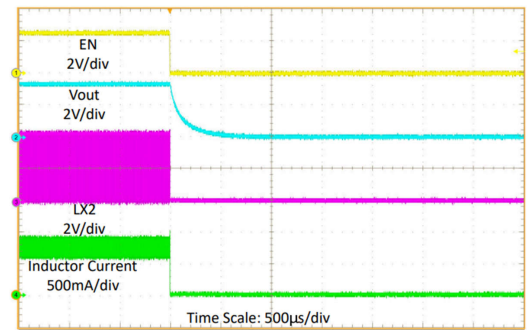

$V_{IN} = 3.6V, V_{OUT} = 3.3V \quad R_{load} = 4\Omega, \text{MODE} = \text{Low}$

Figure 8-12. Shutdown by EN

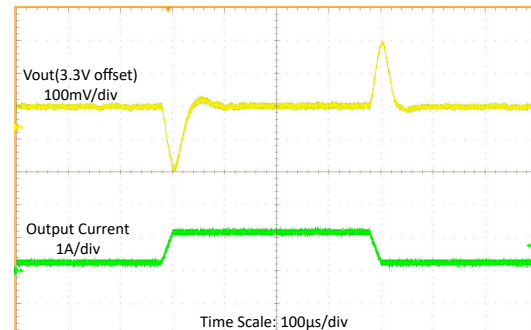

$V_{IN} = 2.7V, V_{OUT} = 3.3V \quad I_{OUT} = 100mA \text{ to } 1A \text{ with } 20\mu s \text{ slew rate}$

Figure 8-13. Load Transient at 2.7V Input Voltage

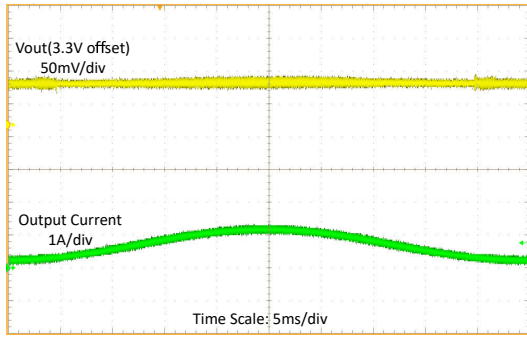

$V_{IN} = 2.7V$, $V_{OUT} = 3.3V$ $I_{OUT} = 100mA$ to 1A sweep

Figure 8-14. Load Sweep at 2.7V Input Voltage

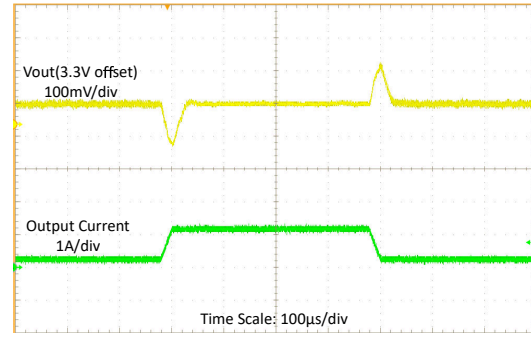

$V_{IN} = 3.6V$, $V_{OUT} = 3.3V$ $I_{OUT} = 100mA$ to 1A with 20µs slew rate

Figure 8-15. Load Transient at 3.6V Input Voltage

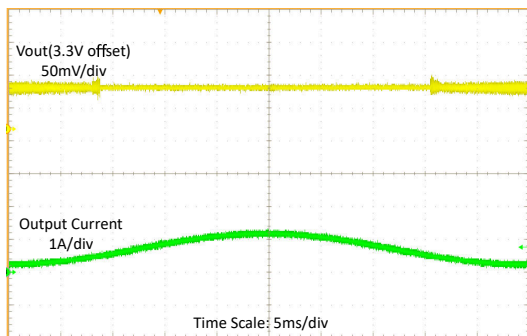

$V_{IN} = 3.6V$, $V_{OUT} = 3.3V$ $I_{OUT} = 100mA$ to 1A sweep

Figure 8-16. Load Sweep at 3.6V Input Voltage

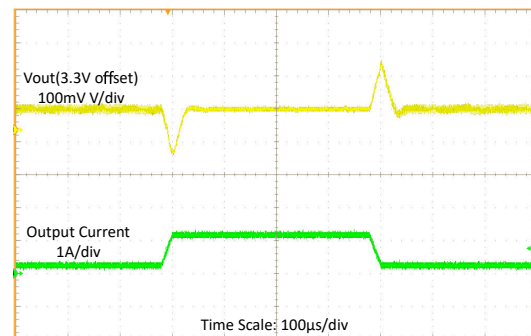

$V_{IN} = 4.3V$, $V_{OUT} = 3.3V$ $I_{OUT} = 100mA$ to 1A with 20µs slew rate

Figure 8-17. Load Transient at 4.3V Input Voltage

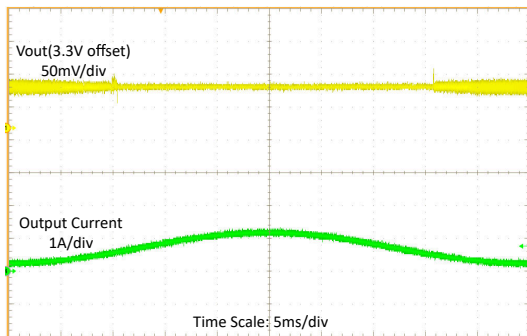

$V_{IN} = 4.3V$, $V_{OUT} = 3.3V$ $I_{OUT} = 100mA$ to 1A sweep

Figure 8-18. Load Sweep at 4.3V Input Voltage

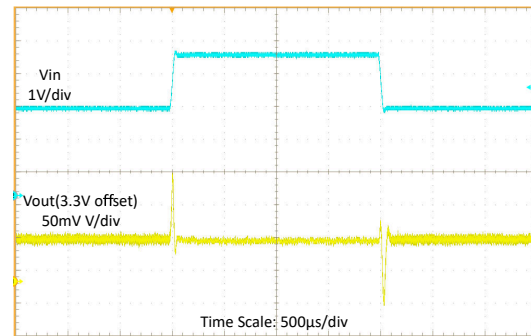

$V_{IN} = 2.7V$ to 4.3V with 20µs slew rate, $V_{OUT} = 3.3V$ $I_{OUT} = 1A$

Figure 8-19. Line Transient at 1A Load Current

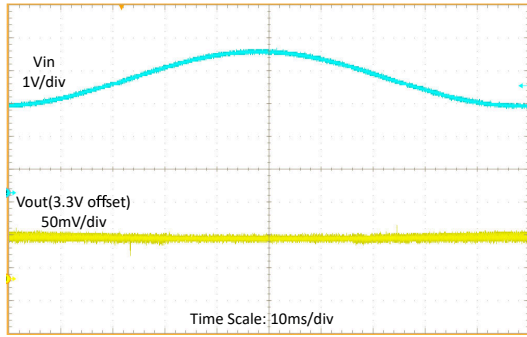

$V_{IN} = 2.7V$ to $4.3V$ sweep, $I_{OUT} = 1A$
 $V_{OUT} = 3.3V$

Figure 8-20. Line Sweep at 1A Load Current

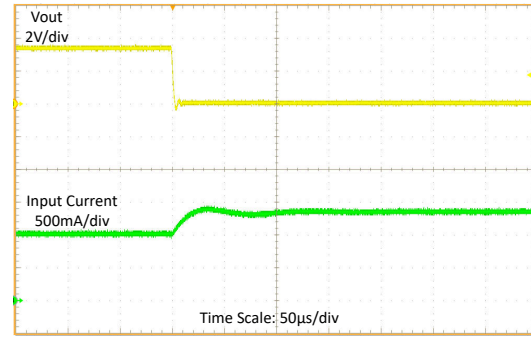

$V_{IN} = 3.6V$, $V_{OUT} = 3.3V$ $I_{OUT} = 1A$, FPWM

Figure 8-21. Output Short Protection (Entry)

Table 8-5. Components for Application Characteristic Curves for $V_{OUT} = 3.3V$

REFERENCE	DESCRIPTION ⁽²⁾	PART NUMBER	MANUFACTURER ⁽¹⁾
U1	High Power Density 1.5A Buck-Boost module	TPSM83100	Texas Instruments
C1	22µF, 0603, Ceramic Capacitor, ±20%, 6.3V	GRM187R61A226ME15	Murata
C2	47µF, 0805, Ceramic Capacitor, ±20%, 6.3V	GRM219R60J476ME44	Murata
R1	511kΩ, 0603 Resistor, 1%, 100mW	Standard	Standard
R2	91kΩ, 0603 Resistor, 1%, 100mW	Standard	Standard

(1) See the [Section 9.1.1](#).

(2) For other output voltages, refer to *Resistor Selection for Typical Output Voltages* for resistor values.

8.3 Power Supply Recommendations

The TPSM83100 and TPSM83101, TPSM83101L have no special requirements for the input power supply. The input power supply output current must be rated according to the supply voltage, output voltage, and output current.

8.4 Layout

8.4.1 Layout Guidelines

The PCB layout is an important step to maintain the high performance of the TPSM83100 device.

- Place input and output capacitors as close as possible to the module. Traces need to be kept short. Route wide and direct traces to the input and output capacitors results in low trace resistance and low parasitic inductance.

8.4.2 Layout Example

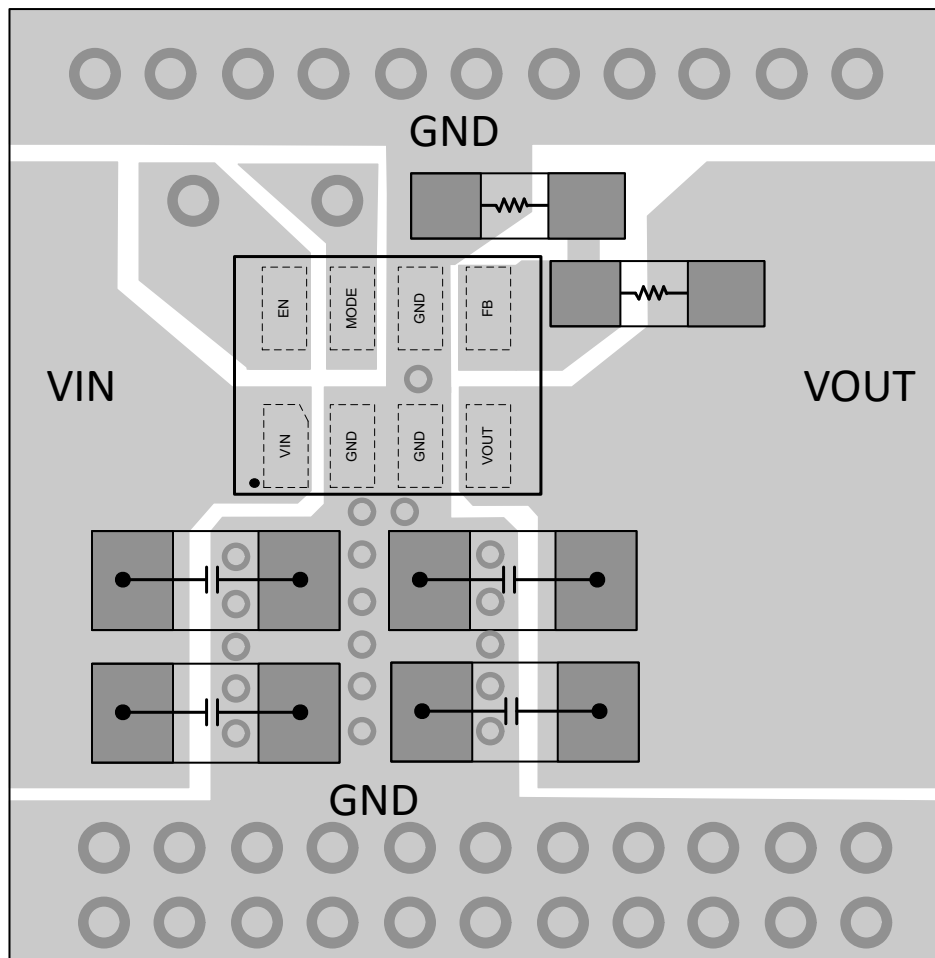

Figure 8-22. Layout Example

9 Device and Documentation Support

9.1 Device Support

9.1.1 Third-Party Products Disclaimer

TI'S PUBLICATION OF INFORMATION REGARDING THIRD-PARTY PRODUCTS OR SERVICES DOES NOT CONSTITUTE AN ENDORSEMENT REGARDING THE SUITABILITY OF SUCH PRODUCTS OR SERVICES OR A WARRANTY, REPRESENTATION OR ENDORSEMENT OF SUCH PRODUCTS OR SERVICES, EITHER ALONE OR IN COMBINATION WITH ANY TI PRODUCT OR SERVICE.

9.1.2 Development Support

9.1.2.1 Custom Design With WEBENCH® Tools

The TPSM83100, TPSM83101, and TPSM83101L reuse the WEBENCH® Power Designer of the TPS631010 ([click here](#)) and TPS631011 ([click here](#)).

1. Start by entering your V_{IN} , V_{OUT} and I_{OUT} requirements.
2. Optimize your design for key parameters like efficiency, footprint or cost using the optimizer dial and compare this design with other possible solutions from Texas Instruments.
3. WEBENCH Power Designer provides you with a customized schematic along with a list of materials with real time pricing and component availability.

The WEBENCH Power Designer provides you with a customized schematic along with a list of materials with real time pricing and component availability.

In most cases, these actions are available:

- Run electrical simulations to see important waveforms and circuit performance,
- Run thermal simulations to understand the thermal performance of your board,
- Export your customized schematic and layout into popular CAD formats,
- Print PDF reports for the design, and share your design with colleagues.

Get more information about WEBENCH tools at www.ti.com/WEBENCH.

9.2 Receiving Notification of Documentation Updates

To receive notification of documentation updates, navigate to the device product folder on ti.com. Click on *Notifications* to register and receive a weekly digest of any product information that has changed. For change details, review the revision history included in any revised document.

9.3 Support Resources

[TI E2E™ support forums](#) are an engineer's go-to source for fast, verified answers and design help — straight from the experts. Search existing answers or ask your own question to get the quick design help you need.

Linked content is provided "AS IS" by the respective contributors. They do not constitute TI specifications and do not necessarily reflect TI's views; see TI's [Terms of Use](#).

9.4 Trademarks

MicroSiP™ and TI E2E™ are trademarks of Texas Instruments.

WEBENCH® is a registered trademark of Texas Instruments.

All trademarks are the property of their respective owners.

9.5 Electrostatic Discharge Caution



This integrated circuit can be damaged by ESD. Texas Instruments recommends that all integrated circuits be handled with appropriate precautions. Failure to observe proper handling and installation procedures can cause damage.

ESD damage can range from subtle performance degradation to complete device failure. Precision integrated circuits may be more susceptible to damage because very small parametric changes could cause the device not to meet its published specifications.

9.6 Glossary

[TI Glossary](#) This glossary lists and explains terms, acronyms, and definitions.

10 Revision History

NOTE: Page numbers for previous revisions may differ from page numbers in the current version.

Changes from Revision B (January 2025) to Revision C (March 2026)	Page
• Added TPSM83101L throughout the datasheet.....	1
• Add WEBENCH link to the <i>Features</i>	1
• Add the column FAST_RAMP to the <i>Device Comparison Table</i>	3
• Updated the CDM testing standards in the <i>ESD Ratings</i> table.....	4
• Added <i>Custom Design With WEBENCH® Tools</i> section.....	10

Changes from Revision A (June 2023) to Revision B (January 2025)	Page
• Removed preview note from TPSM83101.....	3

Changes from Revision * (March 2023) to Revision A (June 2023)	Page
• Changed document status from Advance Information to Production Data.....	1

11 Mechanical, Packaging, and Orderable Information

The following pages include mechanical, packaging, and orderable information. This information is the most current data available for the designated devices. This data is subject to change without notice and revision of this document. For browser-based versions of this data sheet, refer to the left-hand navigation.

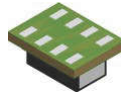

SIU0008A

PACKAGE OUTLINE
MicroSiP™ - 1.2 mm max height

MICRO SYSTEM IN PACKAGE

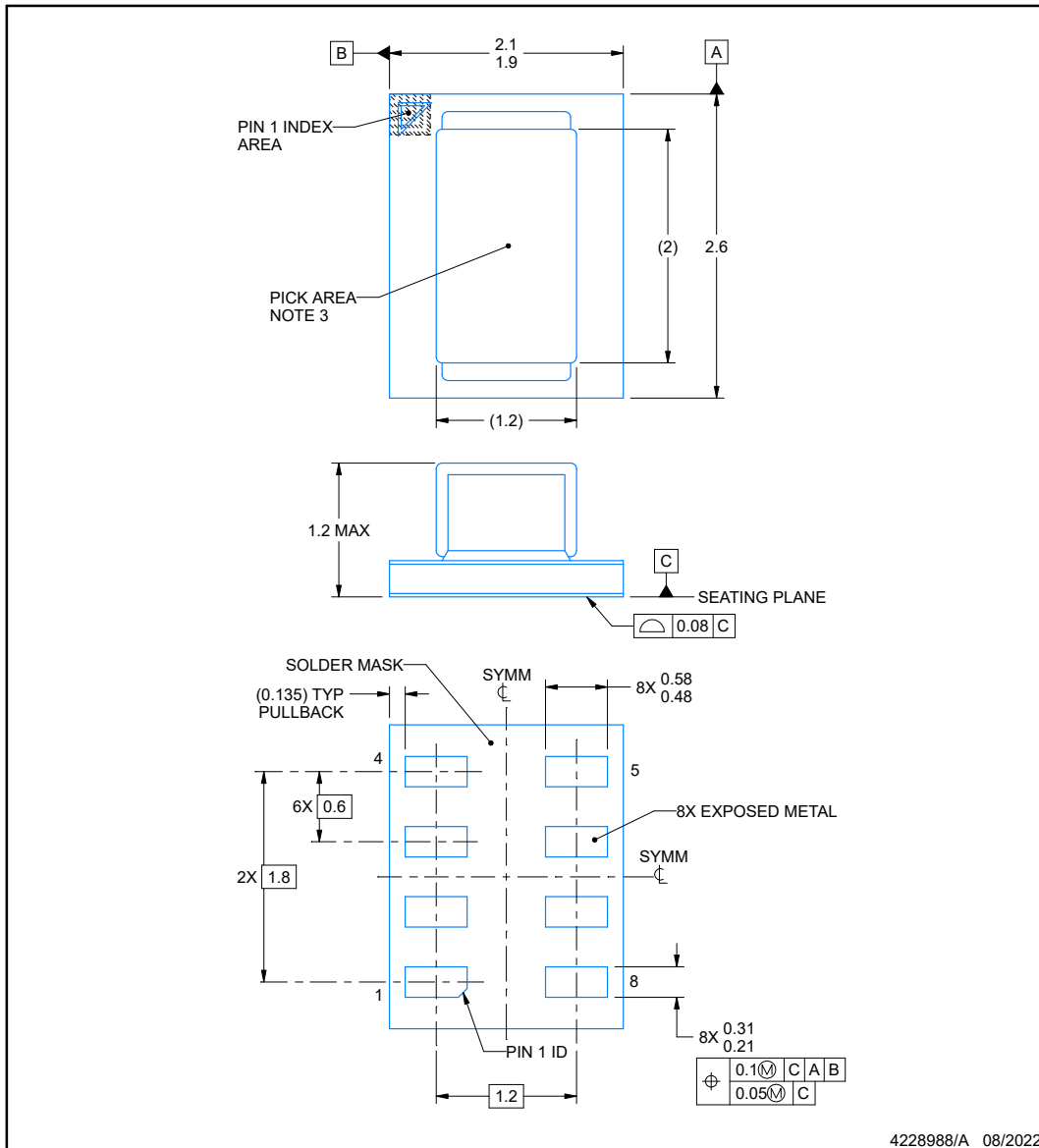

NOTES:

MicroSiP is a trademark of Texas Instruments

1. All linear dimensions are in millimeters. Any dimensions in parenthesis are for reference only. Dimensioning and tolerancing per ASME Y14.5M.
2. This drawing is subject to change without notice.
3. Pick and place nozzle \varnothing 0.33 mm or smaller recommended.

EXAMPLE BOARD LAYOUT

SIU0008A

MicroSiP™ - 1.2 mm max height

MICRO SYSTEM IN PACKAGE

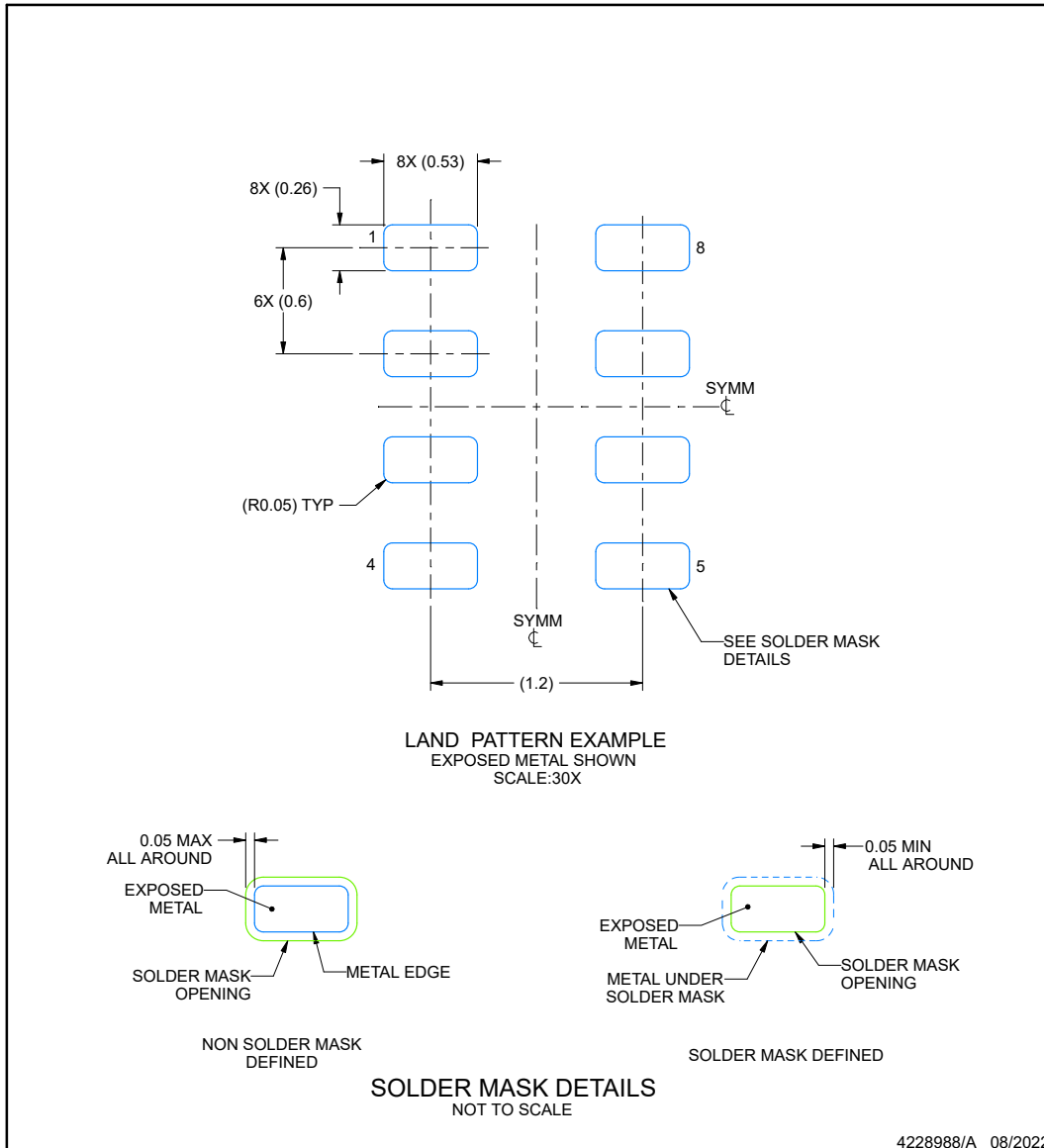

NOTES: (continued)

4. For more information, see Texas Instruments literature number SLUA271 (www.ti.com/lit/slua271).

EXAMPLE STENCIL DESIGN

SIU0008A

MicroSiP™ - 1.2 mm max height

MICRO SYSTEM IN PACKAGE

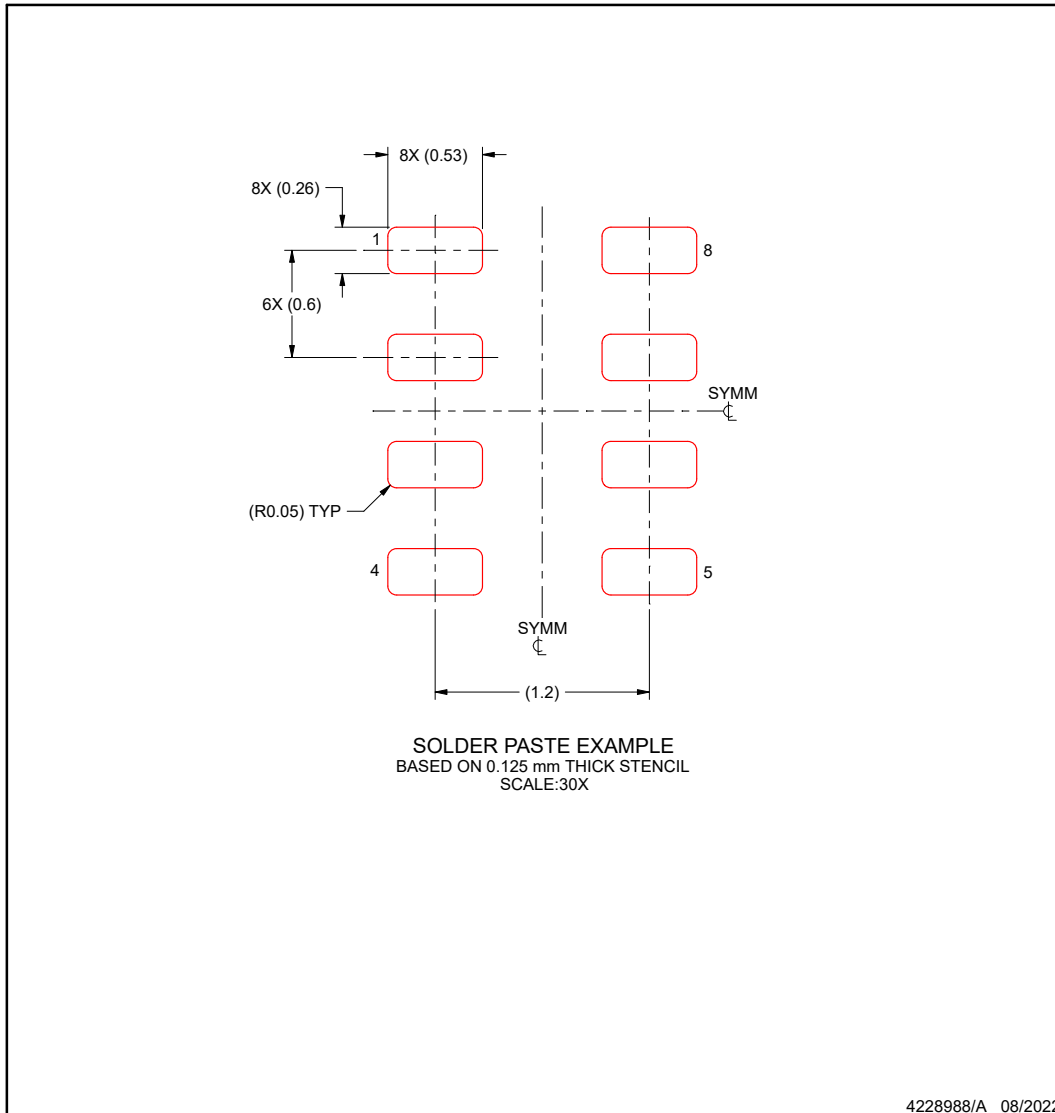

NOTES: (continued)

5. Laser cutting apertures with trapezoidal walls and rounded corners may offer better paste release. IPC-7525 may have alternate design recommendations.

PACKAGING INFORMATION

Orderable part number	Status (1)	Material type (2)	Package Pins	Package qty Carrier	RoHS (3)	Lead finish/ Ball material (4)	MSL rating/ Peak reflow (5)	Op temp (°C)	Part marking (6)
TPSM83100SIUR	Active	Production	uSiP (SIU) 8	3000 LARGE T&R	Yes	NIAU	Level-2-260C-1 YEAR	-40 to 125	31NL TPSM8310X
TPSM83100SIUR.A	Active	Production	uSiP (SIU) 8	3000 LARGE T&R	Yes	NIAU	Level-2-260C-1 YEAR	-40 to 125	31NL TPSM8310X
TPSM83101SIUR	Active	Production	uSiP (SIU) 8	3000 LARGE T&R	Yes	NIAU	Level-2-260C-1 YEAR	-40 to 125	3EIL HYBM83101
TPSM83101SIUR.A	Active	Production	uSiP (SIU) 8	3000 LARGE T&R	Yes	NIAU	Level-2-260C-1 YEAR	-40 to 125	3EIL HYBM83101

(1) **Status:** For more details on status, see our [product life cycle](#).

(2) **Material type:** When designated, preproduction parts are prototypes/experimental devices, and are not yet approved or released for full production. Testing and final process, including without limitation quality assurance, reliability performance testing, and/or process qualification, may not yet be complete, and this item is subject to further changes or possible discontinuation. If available for ordering, purchases will be subject to an additional waiver at checkout, and are intended for early internal evaluation purposes only. These items are sold without warranties of any kind.

(3) **RoHS values:** Yes, No, RoHS Exempt. See the [TI RoHS Statement](#) for additional information and value definition.

(4) **Lead finish/Ball material:** Parts may have multiple material finish options. Finish options are separated by a vertical ruled line. Lead finish/Ball material values may wrap to two lines if the finish value exceeds the maximum column width.

(5) **MSL rating/Peak reflow:** The moisture sensitivity level ratings and peak solder (reflow) temperatures. In the event that a part has multiple moisture sensitivity ratings, only the lowest level per JEDEC standards is shown. Refer to the shipping label for the actual reflow temperature that will be used to mount the part to the printed circuit board.

(6) **Part marking:** There may be an additional marking, which relates to the logo, the lot trace code information, or the environmental category of the part.

Multiple part markings will be inside parentheses. Only one part marking contained in parentheses and separated by a "-" will appear on a part. If a line is indented then it is a continuation of the previous line and the two combined represent the entire part marking for that device.

Important Information and Disclaimer: The information provided on this page represents TI's knowledge and belief as of the date that it is provided. TI bases its knowledge and belief on information provided by third parties, and makes no representation or warranty as to the accuracy of such information. Efforts are underway to better integrate information from third parties. TI has taken and continues to take reasonable steps to provide representative and accurate information but may not have conducted destructive testing or chemical analysis on incoming materials and chemicals. TI and TI suppliers consider certain information to be proprietary, and thus CAS numbers and other limited information may not be available for release.

In no event shall TI's liability arising out of such information exceed the total purchase price of the TI part(s) at issue in this document sold by TI to Customer on an annual basis.

TAPE AND REEL INFORMATION

QUADRANT ASSIGNMENTS FOR PIN 1 ORIENTATION IN TAPE

*All dimensions are nominal

Device	Package Type	Package Drawing	Pins	SPQ	Reel Diameter (mm)	Reel Width W1 (mm)	A0 (mm)	B0 (mm)	K0 (mm)	P1 (mm)	W (mm)	Pin1 Quadrant
TPSM83100SIUR	uSiP	SIU	8	3000	330.0	12.4	2.3	2.9	1.35	8.0	12.0	Q1
TPSM83101SIUR	uSiP	SIU	8	3000	330.0	12.4	2.3	2.9	1.35	8.0	12.0	Q1

TAPE AND REEL BOX DIMENSIONS

*All dimensions are nominal

Device	Package Type	Package Drawing	Pins	SPQ	Length (mm)	Width (mm)	Height (mm)
TPSM83100SIUR	uSiP	SIU	8	3000	383.0	353.0	58.0
TPSM83101SIUR	uSiP	SIU	8	3000	383.0	353.0	58.0

IMPORTANT NOTICE AND DISCLAIMER

TI PROVIDES TECHNICAL AND RELIABILITY DATA (INCLUDING DATASHEETS), DESIGN RESOURCES (INCLUDING REFERENCE DESIGNS), APPLICATION OR OTHER DESIGN ADVICE, WEB TOOLS, SAFETY INFORMATION, AND OTHER RESOURCES "AS IS" AND WITH ALL FAULTS, AND DISCLAIMS ALL WARRANTIES, EXPRESS AND IMPLIED, INCLUDING WITHOUT LIMITATION ANY IMPLIED WARRANTIES OF MERCHANTABILITY, FITNESS FOR A PARTICULAR PURPOSE OR NON-INFRINGEMENT OF THIRD PARTY INTELLECTUAL PROPERTY RIGHTS.

These resources are intended for skilled developers designing with TI products. You are solely responsible for (1) selecting the appropriate TI products for your application, (2) designing, validating and testing your application, and (3) ensuring your application meets applicable standards, and any other safety, security, regulatory or other requirements.

These resources are subject to change without notice. TI grants you permission to use these resources only for development of an application that uses the TI products described in the resource. Other reproduction and display of these resources is prohibited. No license is granted to any other TI intellectual property right or to any third party intellectual property right. TI disclaims responsibility for, and you fully indemnify TI and its representatives against any claims, damages, costs, losses, and liabilities arising out of your use of these resources.

TI's products are provided subject to [TI's Terms of Sale](#), [TI's General Quality Guidelines](#), or other applicable terms available either on ti.com or provided in conjunction with such TI products. TI's provision of these resources does not expand or otherwise alter TI's applicable warranties or warranty disclaimers for TI products. Unless TI explicitly designates a product as custom or customer-specified, TI products are standard, catalog, general purpose devices.

TI objects to and rejects any additional or different terms you may propose.

Copyright © 2026, Texas Instruments Incorporated

Last updated 10/2025