

TI's Latest Signal Isolators with Integrated Power Achieves Lowest Radiated Emissions



Varun Kumar

ISOW6441 - TI's Latest Signal Isolator with Integrated Power

As modern electronics increasingly integrate switching power stages, electromagnetic compatibility (EMC) performance has become a critical differentiator for digital isolators with integrated DC/DC converters. The [ISOW6441](#) from Texas Instruments is TI's latest-generation, catalog-rated, 4-channel reinforced digital isolator with integrated DC/DC power. ISOW6441 is engineered from the ground up to deliver industry-leading radiated emissions performance — specifically designed to meet and exceed the stringent requirements of CISPR 32 Class B — the internationally recognized multimedia equipment EMC standard.

For digital isolators with integrated switching DC/DC converters, compliance with CISPR 32 Class B is particularly challenging due to:

- High-frequency switching transients (in the tens to hundreds of MHz range)
- Common-mode and differential-mode current loops formed across the isolation barrier.
- Long PCB traces and cables acting as antennas.

TI's latest design ISOW6441 addresses all the above challenges effectively while no other competitor device comes close to the performance of ISOW6441 in terms of clean emissions . [Table 1](#) shows the comparative data with pin compatible competition devices in the industry and show that ISOW6441 radiated emissions have >10dB margin from the limit lines and comfortably meet CISPR32 Class-B with no sharp peaks at any frequency across the spectrum, while both the competition devices fail quite aggressively by breaching the limit lines on the exact same setup as shown in [Figure 9](#).

For more detailed test results of ISOW6441, see [Passing CISPR 32 Class-B Radiated Emissions With Ease Using ISOW6441](#).

Table 1. Summary of ISOW6441 vs Competition Devices for CISPR32 Class-B Radiated Emission Compliance

	V _{DD} (V)	V _{ISO} (V)	V _{ISO} load (mA)	Frequency Range	PASS/FAIL	Emissions Spectrum
ISOW6441	5	5	110	30MHz-1GHz	PASS (>10dB Margin)	Figure 1
ISOW6441	3.3	3.3	60	30MHz-1GHz	PASS (>10dB Margin)	Figure 2
Competitor Device A	5	5	100	30MHz-1GHz	FAIL	Figure 3
Competitor Device A	3.3	3.3	60	30MHz-1GHz	FAIL	Figure 4
Competitor Device B	5	5	100	30MHz-1GHz	FAIL	Figure 5
Competitor Device B	3.3	3.3	60	30MHz-1GHz	FAIL	Figure 6

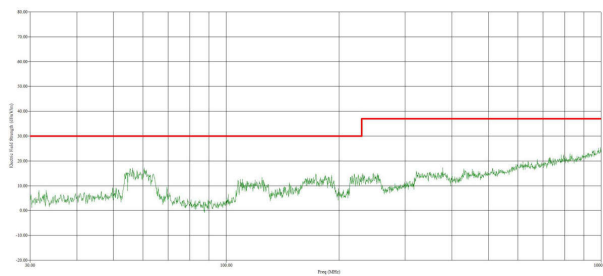

Figure 1. ISOW6441 - CISPR32 Class-B Radiated Emissions Results with 5V Input, 5V Output, 110mA Load (Max Load)

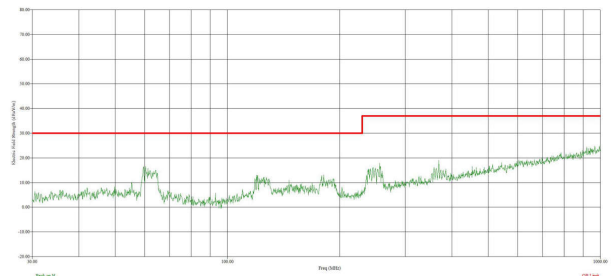

Figure 2. ISOW6441 - CISPR32 Class-B Radiated Emissions Results with 3.3V Input, 3.3V Output, 60mA Load (Max Load)

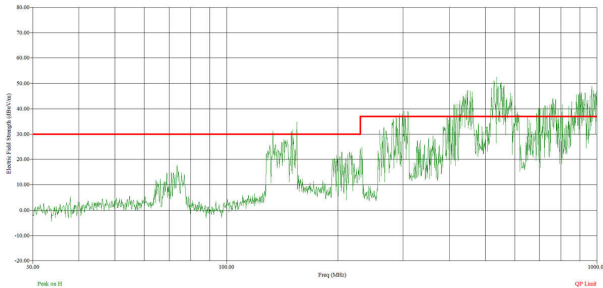

Figure 3. Competitor Device A - CISPR32 Class-B Radiated Emissions Results with 5V Input, 5V Output, 100mA Load (Max Load)

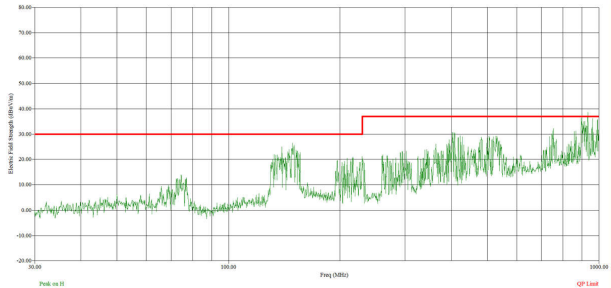

Figure 4. Competitor Device A - CISPR32 Class-B Radiated Emissions Results with 3.3V Input, 3.3V Output, 60mA Load (Max Load)

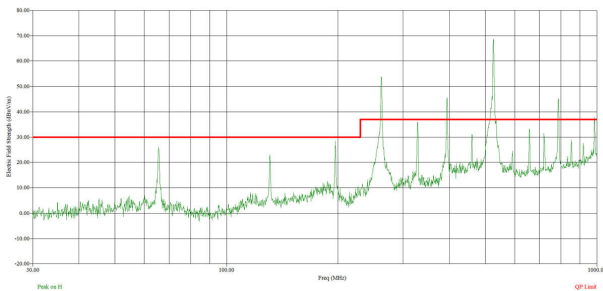

Figure 5. Competitor Device B - CISPR32 Class-B Radiated Emissions Results with 5V Input, 5V Output, 100mA Load (Max Load)

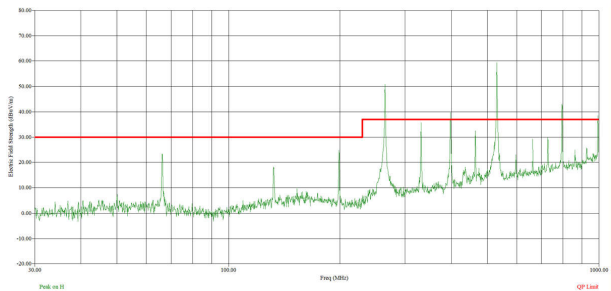

Figure 6. Competitor Device B - CISPR32 Class-B Radiated Emissions Results with 3.3V Input, 3.3V Output, 60mA Load (Max Load)

What are the Major Sources of Radiated Emissions in Isolated DC/DC Converters?

Electromagnetic radiations can emit from an isolated switching converter on a given PCB in the form of either common-mode current loop or differential-mode current loop as shown in [Figure 7](#).

1. Common-Mode Current Loops

Fast transients from the DC/DC converter couple through parasitic capacitances between the isolated grounds on the PCB. Because the two sides are galvanically isolated, the induced current forms a large return loop through air and board-level parasitic capacitances, effectively creating a dipole antenna between the two isolated halves of the system.

2. Differential-Mode Current Loops

High voltage ripple on either the input supply (VDD) or the isolated output supply (VISO) traces creates differential-mode current loops on each side of the isolation barrier. These loops radiate in proportion to the loop area and the rate of current change.

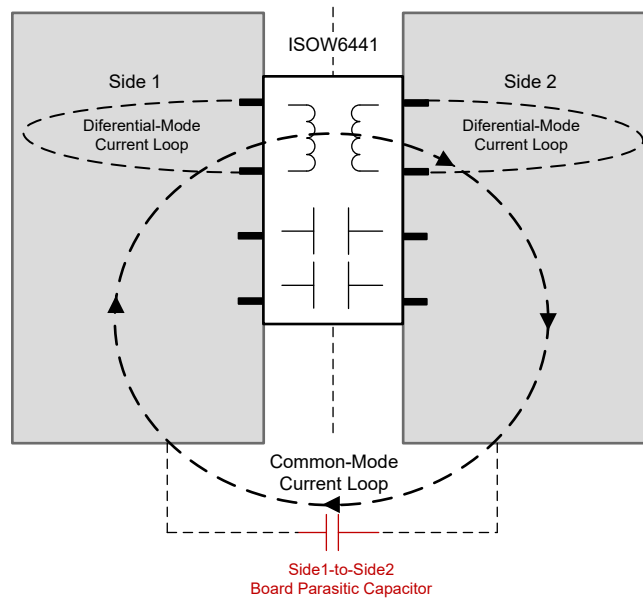

Figure 7. Common-Mode and Differential-Mode Current Loops Formation on PCB

The [ISOW6441](#), TI's latest signal isolator with integrated power, switches at approximately 60MHz which is a frequency specifically chosen to keep the integrated transformer small while maintaining high power efficiency. This switching frequency and the subsequent harmonics fall directly within the CISPR 32 measurement band, making emissions management critical..

How ISOW6441 Achieves Best Radiated Emission Performance

TI has implemented multiple hardware and architectural innovations to deliver best-in-class emissions performance:

1. Patented Symmetric Design Architecture

The ISOW6441 uses a patented symmetric design architecture which minimizes the net electromagnetic moment from switching currents, thereby suppressing common-mode radiation at the source. This is a fundamental design differentiation from competition devices and directly contributes to achieving the best cost-to-performance ratio available in the market.

2. Spread Spectrum Clocking (SSC)

To avoid energy concentration at discrete harmonic frequencies, the ISOW6441 employs spread spectrum clocking. This technique distributes switching energy over a range of frequencies, reducing peak emissions at any single frequency point — a key enabler for clearing CISPR 32 Class B limits with substantial margin.

3. Minimal External Component Requirements

Unlike many competing devices that require complex, multi-layer PCBs or extensive external filtering networks to pass emissions standards, the ISOW6441 is designed to meet CISPR 32 Class B with >10dB margin using:

- A cost-effective 2-layer PCB
- A simple PCB layout.
- Minimal external components.

This simplifies system design, reduces BOM cost, and lowers design complexity which helps in achieving the best cost-to-performance ratio in the market.

[Figure 8](#) shows an example 2-Layer PCB layout. For more details refer the EVM - [ISOW6441DWEEVM](#).

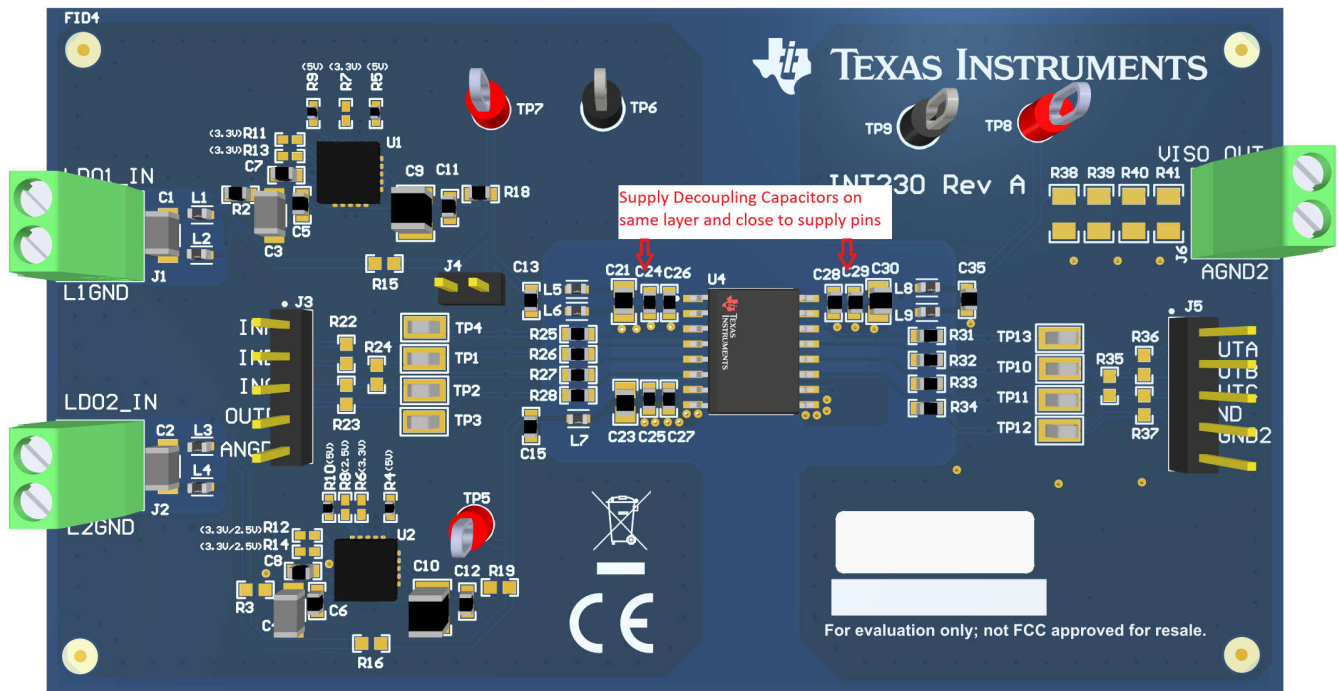

Figure 8. Example Layout using 2-Layer PCB

Radiated Emissions Test Setup for ISOW6441 and Competition Devices

ISOW6441 and the pin-to-pin compatible competition devices were tested for CISPR32 Class-B radiated emissions on the exact same setup using batteries with very short wires to eliminate any external amplifying effects on overall emissions for competition devices and ISOW6441. Figure 9 shows the evaluation module ISOW6441DWEEVM powered using a 9V alkaline battery with very short connecting wires.

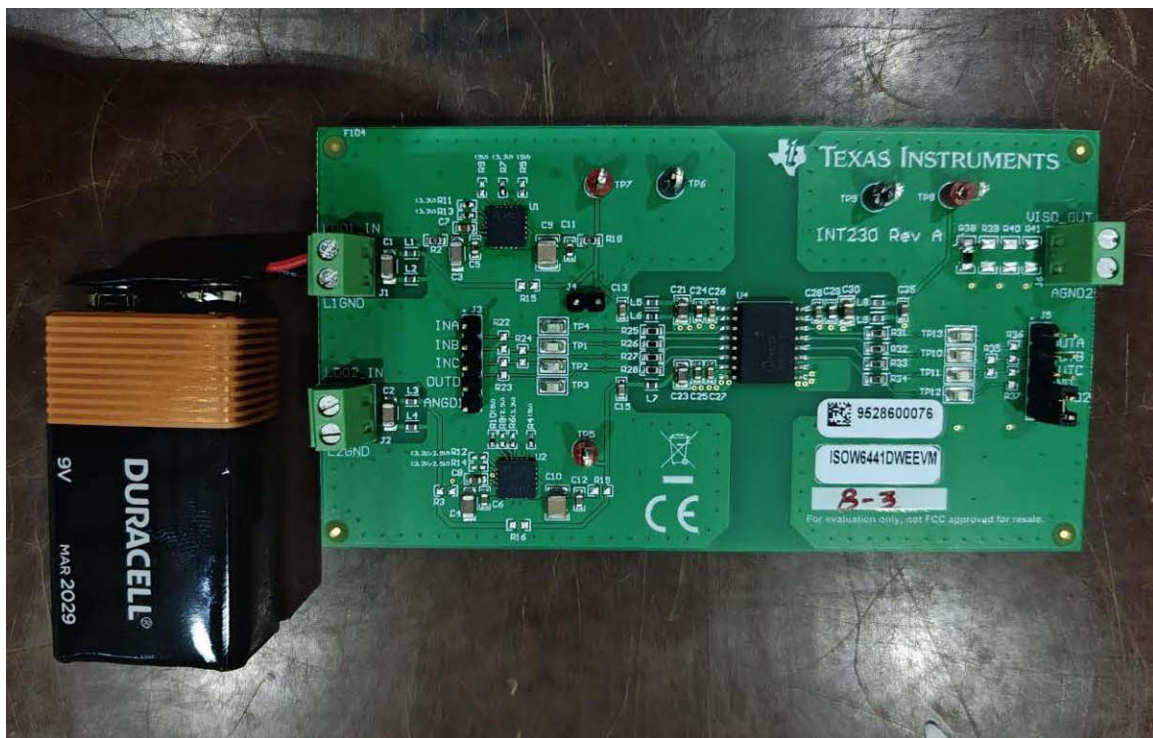

Figure 9. ISOW6441DWEEVM Emissions Test Setup Using a Battery

According to the CISPR 32 standard, the radiated emissions limits are specified as quasi-peak limits, although the peak-detector scan is typically used to get a quick result for comparative study. The device ISOW6441 uses spread spectrum clocking to change the switching frequency across a small band of frequencies instead of concentrating all the power at one single frequency. Techniques such as this show significantly better results when subjected to quasi-peak scans.

The comparative results shown in this document is measured using peak-detector scan to compare the frequencies for the worst-case measurements and also to save the overall measurement time. Seeing the results in this document as per peak scan, user can proceed directly for the quasi-peak scan at the select worst-case frequencies of interest during evaluation phase of system design to estimate the true margin from the CISPR 32 quasi-peak limit line.

ISOW6441 CISPR32 Radiated Emissions Data Against Competition

For comparison with current in-market devices, which are pin-to-pin compatible with TI's latest ISOW6441 isolator with integrated power, two competition devices were tested on the ISOW6441DWEEVM along with ISOW6441 with max supported load in two particular configurations:

- VDD = 5V and VISOOUT = 5V, Max supported ILOAD of 110mA(ISOW6441) and 100mA(Competition)
- VDD = 3.3V and VISOOUT = 3.3V, Max supported ILOAD of 60mA(ISOW6441 and Competition)

Only the worst-case results which are primarily in the range of 30MHz-1GHz, for ISOW6441 as well as Competition devices, are shared below. For more detailed test results of ISOW6441, see [Passing CISPR 32 Class-B Radiated Emissions With Ease Using ISOW6441](#)

Table 1 shows the comparative data with pin compatible competition devices in the industry and show that ISOW6441 radiated emissions have >10dB margin from the limit lines and comfortably meet CISPR32 Class-B with no sharp peaks at any frequency across the spectrum, while both the competition devices fail quite aggressively by breaching the limit lines on the exact same setup as shown in [Figure 9](#).

Conclusion

The ISOW6441 sets a new benchmark for radiated emission performance among digital isolators with integrated DC/DC power. Through a combination of patented symmetric architecture, spread spectrum clocking, and minimal external components, ISOW6441 achieves CISPR 32 Class B compliance with greater than 10dB margin across all voltage configurations and maximum load using only a simple, cost-effective 2-layer board.

For system designers targeting low-EMI, high-reliability isolated designs (particularly in industrial, communications, and consumer multimedia applications) the ISOW6441 delivers the best cost-to-performance ratio in the market today.

References

1. Texas Instruments, [Passing CISPR 32 Class-B Radiated Emissions With Ease Using ISOW6441](#), application note.
2. Texas Instruments, [Passing CISPR 25 Class-5 Automotive Radiated Emissions Using ISOW6441](#), application note.
3. Texas Instruments, [ISOW644x EVM Datasheet for Layout Guidance](#), evaluation module.
4. Texas Instruments, [ISOW644x Robust-EMC, Reinforced, Quad-Channel Digital Isolator With Integrated DCDC Converter](#), datasheet.
5. Texas Instruments, [Enhance Design Performance Using Integrated Power and Digital Isolation Design](#), application brief.

Trademarks

All trademarks are the property of their respective owners.

IMPORTANT NOTICE AND DISCLAIMER

TI PROVIDES TECHNICAL AND RELIABILITY DATA (INCLUDING DATASHEETS), DESIGN RESOURCES (INCLUDING REFERENCE DESIGNS), APPLICATION OR OTHER DESIGN ADVICE, WEB TOOLS, SAFETY INFORMATION, AND OTHER RESOURCES "AS IS" AND WITH ALL FAULTS, AND DISCLAIMS ALL WARRANTIES, EXPRESS AND IMPLIED, INCLUDING WITHOUT LIMITATION ANY IMPLIED WARRANTIES OF MERCHANTABILITY, FITNESS FOR A PARTICULAR PURPOSE OR NON-INFRINGEMENT OF THIRD PARTY INTELLECTUAL PROPERTY RIGHTS.

These resources are intended for skilled developers designing with TI products. You are solely responsible for (1) selecting the appropriate TI products for your application, (2) designing, validating and testing your application, and (3) ensuring your application meets applicable standards, and any other safety, security, regulatory or other requirements.

These resources are subject to change without notice. TI grants you permission to use these resources only for development of an application that uses the TI products described in the resource. Other reproduction and display of these resources is prohibited. No license is granted to any other TI intellectual property right or to any third party intellectual property right. TI disclaims responsibility for, and you fully indemnify TI and its representatives against any claims, damages, costs, losses, and liabilities arising out of your use of these resources.

TI's products are provided subject to [TI's Terms of Sale](#), [TI's General Quality Guidelines](#), or other applicable terms available either on ti.com or provided in conjunction with such TI products. TI's provision of these resources does not expand or otherwise alter TI's applicable warranties or warranty disclaimers for TI products. Unless TI explicitly designates a product as custom or customer-specified, TI products are standard, catalog, general purpose devices.

TI objects to and rejects any additional or different terms you may propose.

Copyright © 2026, Texas Instruments Incorporated

Last updated 10/2025