

Using the TPS92010EVM-631

User's Guide



Literature Number: SLUU430C
July 2010–Revised May 2011

A 230-VAC TRIAC Dimmable 6-W LED Driver

1 Introduction

The TPS92010EVM-631 is a TRIAC dimmable LED driver. It can provide 0.325-A constant current to four or five high-brightness LED's. The EVM includes a five-LED load. It is powered from the mains which is rated at 185 V_{RMS} to 265 V_{RMS} . The output current can be modified for constant levels from 0.2 A to 0.7 A.

2 Description

This EVM uses the TPS92010 high-efficiency offline LED lighting driver controller. The power topology is a quasi resonant mode flyback. This makes for a cost competitive solution. This TPS92010 EVM implements a constant current, high-efficiency, low-ripple AC-DC LED lighting driver

Current sensing is done directly via a resistor and op-amp. This in turn drives an opto-coupler which sets the PWM pulses via the TPS92010 to control the output current at a constant level. The design also incorporates a circuit to ensure compatibility with a large number of commonly available TRIAC based dimmers. This circuit monitors the line voltage for TRIAC operation. Then the TRIAC is operating the line voltage is chopped. This information is used by the circuit to reduce the constant output current level thus dimming the LED's. It also applies a current path at the input to ensure the TRIAC triggers correctly.

2.1 Typical Applications

- Household Light Bulb Replacement

2.2 Features

- TRIAC Compatible Dimming
- Low Cost Line Powered LED Driver Solution
- Includes Five HB-LED's as a Sample Load
- Allows Easy Use of Users Own LED Load
- Test Points for LED Voltage and Current
- Accurate Current Sensing to Maintain Constant Current to LED's
- Modifiable Output Current from 0.2 A to 0.7 A, 0.325 A is Default

3 Electrical Performance Specifications

Table 1. Electrical Performance Specifications

PARAMETER	TEST CONDITIONS	MIN	TYP	MAX	UNITS
Input Characteristics					
Voltage range ⁽¹⁾		185		265	V_{RMS}
Maximum input current			0.53		A_{RMS}
Output Characteristics					
Output voltage, V_{OUT}		14		17	V_{DC}
Output load current, I_{OUT}	Input voltage = 200 VAC to 265 VAC	0.31	0.325	0.34	A_{DC}
Systems Characteristics					
Efficiency			85%		

⁽¹⁾ Input voltages below 200 VAC may result in reduced output current.

4 Schematic

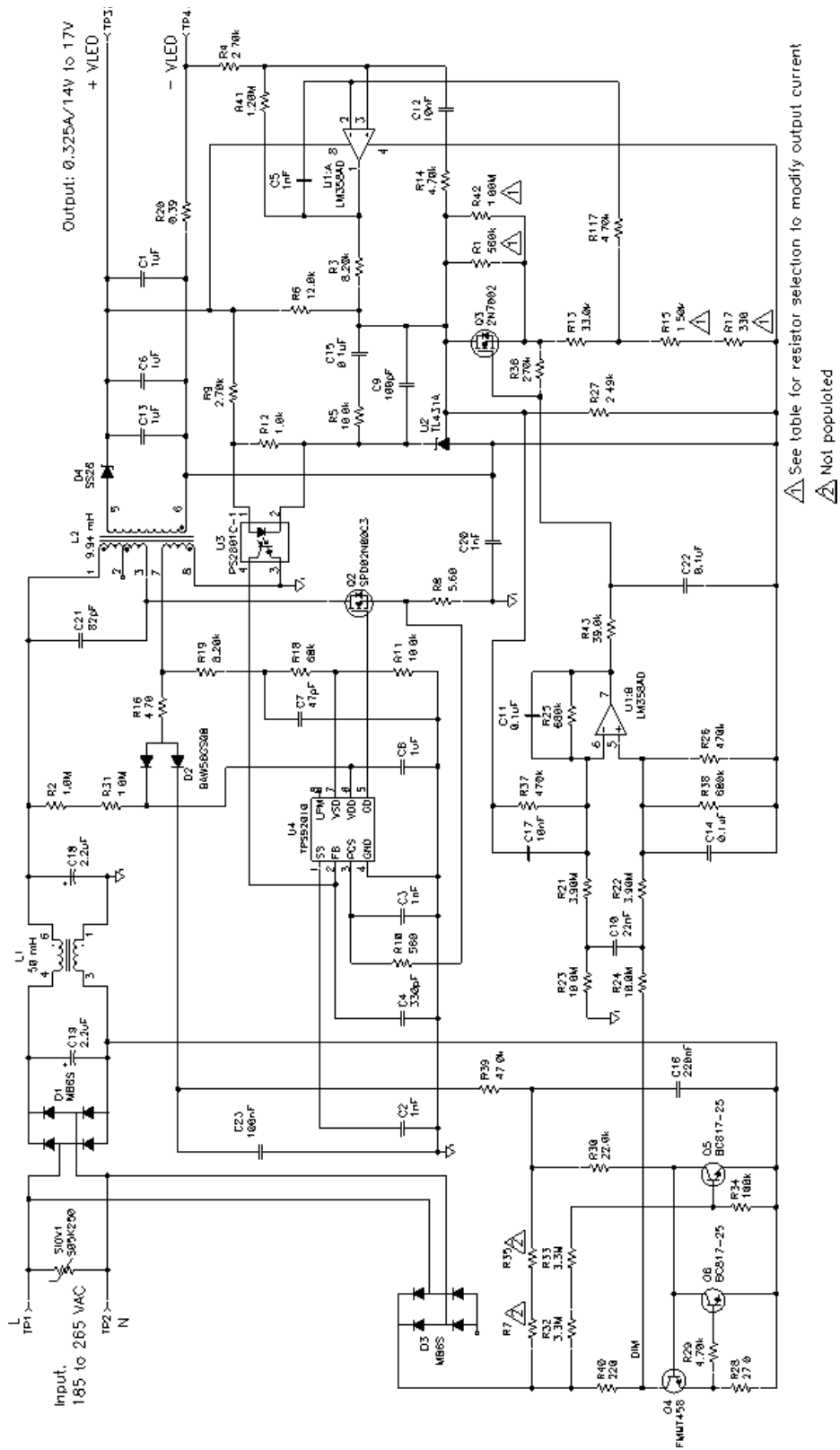

Figure 1. PSU Schematic

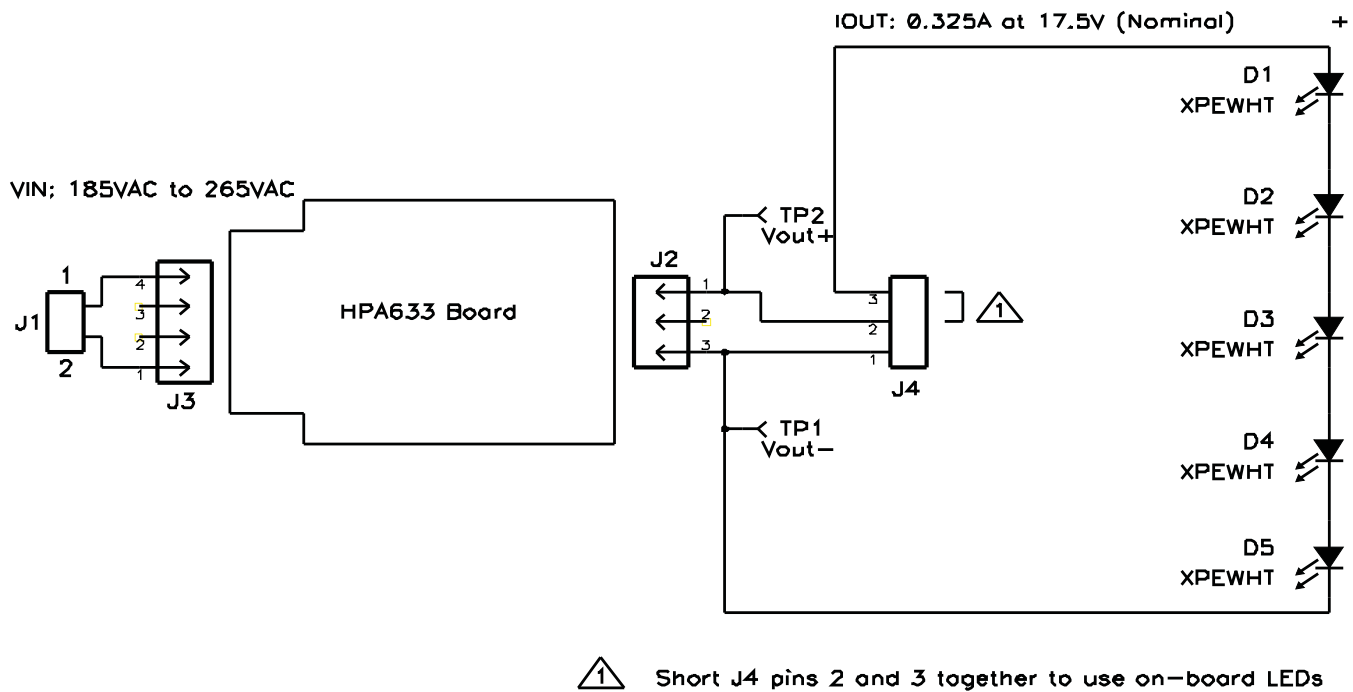

Figure 2. LED Board Schematic

5 Test Setup

5.1 Test Equipment

Voltage Source: 185- V_{RMS} to 265- V_{RMS} AC source.

Multimeters: Voltmeter for up to 20 V_{DC} and an ammeter for up to 1 A

Output Load: Load provided or LED load that sinks 0.325 A_{DC} and has a voltage drop between 14 V_{DC} to 17 V_{DC}

Recommended Wire Gauge: 18 AWG

5.2 Configuring the Output Current

The TPS92010EVM-631 can be configured for different output current levels. Soldering of 0402 parts is required to do this. [Table 2](#) below shows the resistor values necessary for various current levels. [Figure 3](#) shows the location of these resistors on the top side of the PSU board.

Table 2. Resistor Values to Modify Output Current

MAX OUTPUT CURRENT (mA)	MIN OUTPUT CURRENT (mA)	R15 (Ω)	R17 (Ω)	R1 (kΩ)	R42 (kΩ)
200	10	1000	150	330	1000
225	10	1200	86	390	1000
250	10	1200	220	470	1000
275	10	1000	560	680	680
300	10	1500	220	680	680
325 ⁽¹⁾	10	1500	330	560	1000
350	10	1000	1000	820	1000
400	10	1800	470	1000	1000
450	10	2200	390	1500	1000
500	12	2700	220	1500	1000
600	12	3300	150	1500	1500
700	13	3900	270	2200	1500

⁽¹⁾ 325 mA is the default setting when the EVM is shipped.

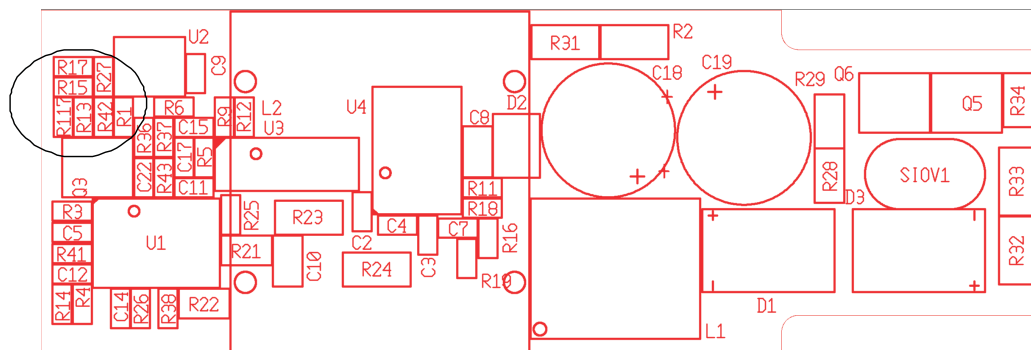

Figure 3. Resistor Locations to Modify Output Current

5.3 Recommended Test Setup

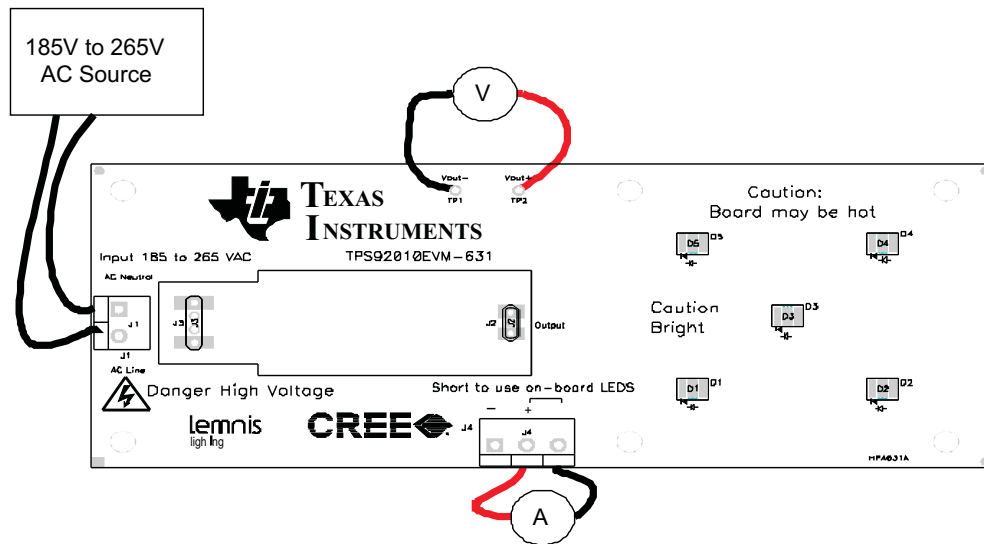

Figure 4. Recommended Test Set Up Using Internal Load

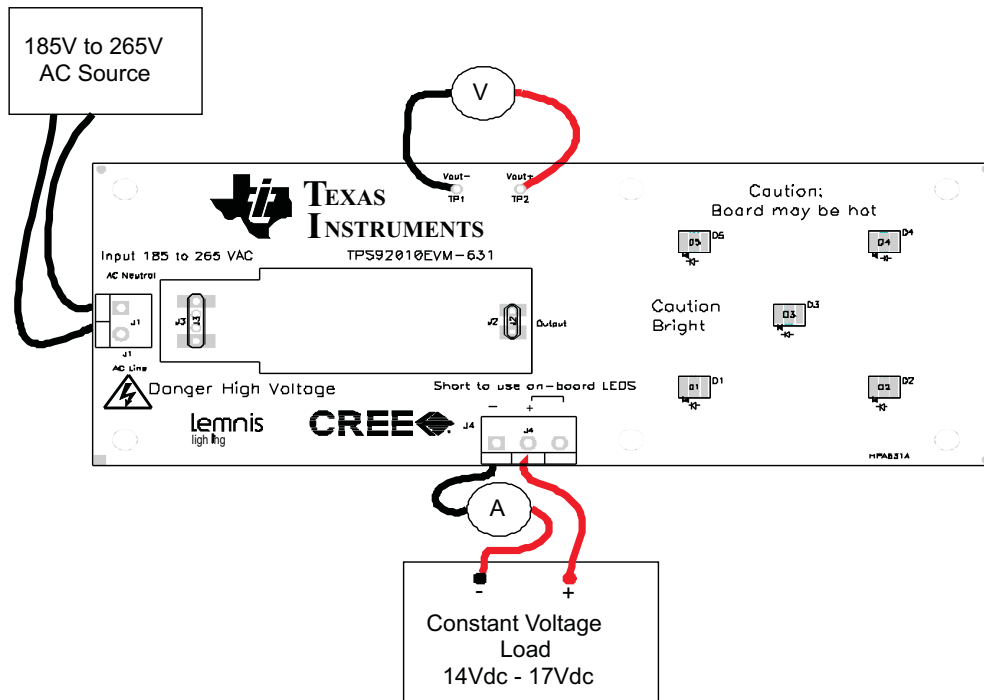

Figure 5. Recommended Test Set Up Using External Load

6 Test Procedure

CAUTION

CAUTION: High voltages exist on this EVM. Please handle with care. Do not touch EVM when powered.

This EVM allows the user to use one of two different set ups.

1. **Internal Load:** The EVM provides five on-board LED's. To use these a short or ammeter must be connected between pins 2 and 3 of J4, see [Figure 4](#) above
2. **External Load:** If the user wants to validate the EVM with their own load pins 1 and 2 of J4 should be used. Any short between pins 2 and 3 should be removed to avoid damaging the EVM. See [Figure 5](#) above.

WARNING

Do not operate the EVM without a load, see points 1 and 2 above.

6.1 Line Regulation and Efficiency Measurement Procedure

1. Connect EVM per [Figure 4](#) or [Figure 5](#) above.
2. Set AC source to 185 V_{RMS} .
3. Turn on AC source.
4. Record output voltage reading from V and output current reading from A.
5. Increase output voltage by 5 V_{RMS} .
6. Repeat steps 4 and 5 until you reach 265 V_{RMS} .
7. Shutdown equipment per section 6.3.

6.2 Verifying Dimming Function

1. Set up the EVM per [Figure 4](#) or [Figure 5](#).
2. Add TRIAC dimmer to the input per [Figure 6](#).
3. Set AC source to 230 V_{RMS}.
4. Set TRIAC to maximum output.
5. Measure output current.
6. Slowly increase TRIAC dimming to minimum output.
7. Observe output current reduces.

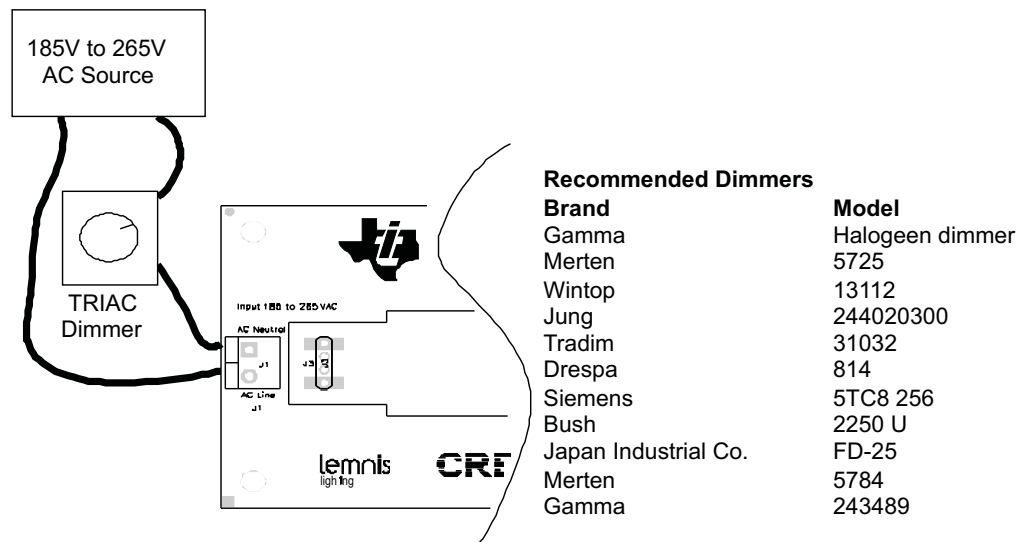

Figure 6. Test Up Using TRIAC Dimmer

6.3 Equipment Shutdown

1. Turn off AC source.
2. Wait several minutes before handling the EVM.

7 Performance Data and Typical Characteristic Curves

Figure 7 through Figure 10 present typical performance curves for TPS92010EVM-631.

7.1 Efficiency

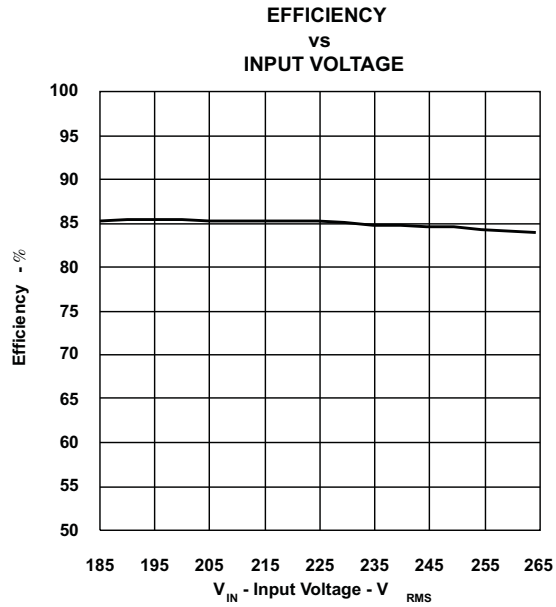

Figure 7. Efficiency

7.2 Line Regulation

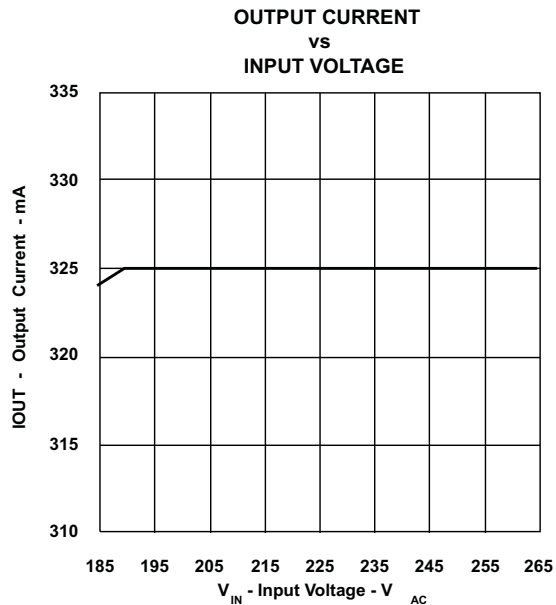

Figure 8. Line Regulation

7.3 Dimmer Performance

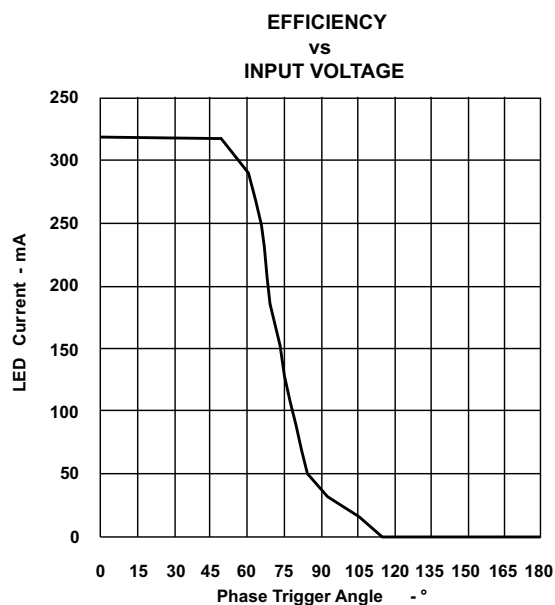

Figure 9. Output Current Versus Dimmer Phase Angle

7.4 Output Current Ripple

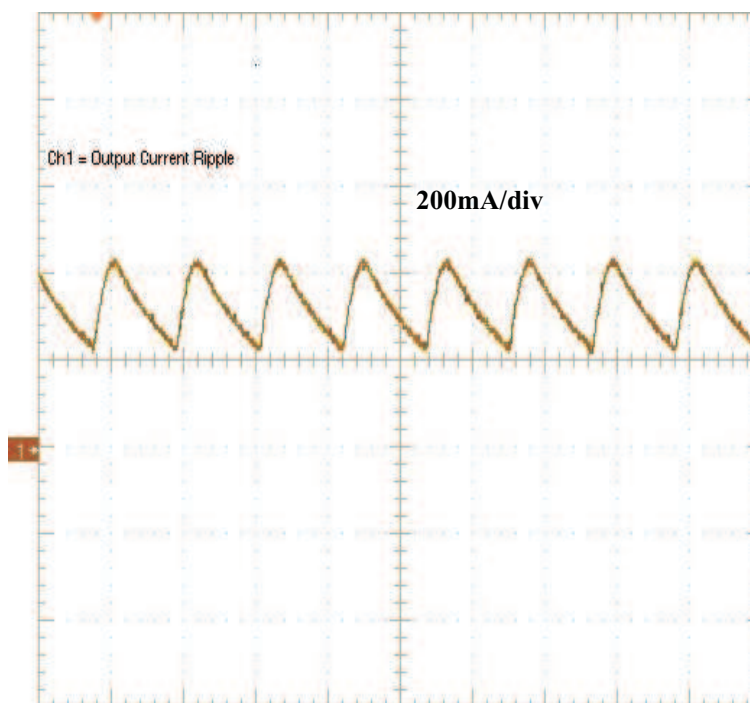

Figure 10. Output Current Ripple with Dimmer at 0% Dim, (10 μ s/div.)

8 EVM Assembly Drawing and PCB layout

The following figures (Figure 11 through Figure 14) show the design of the TPS92010EVM-631 printed circuit board.

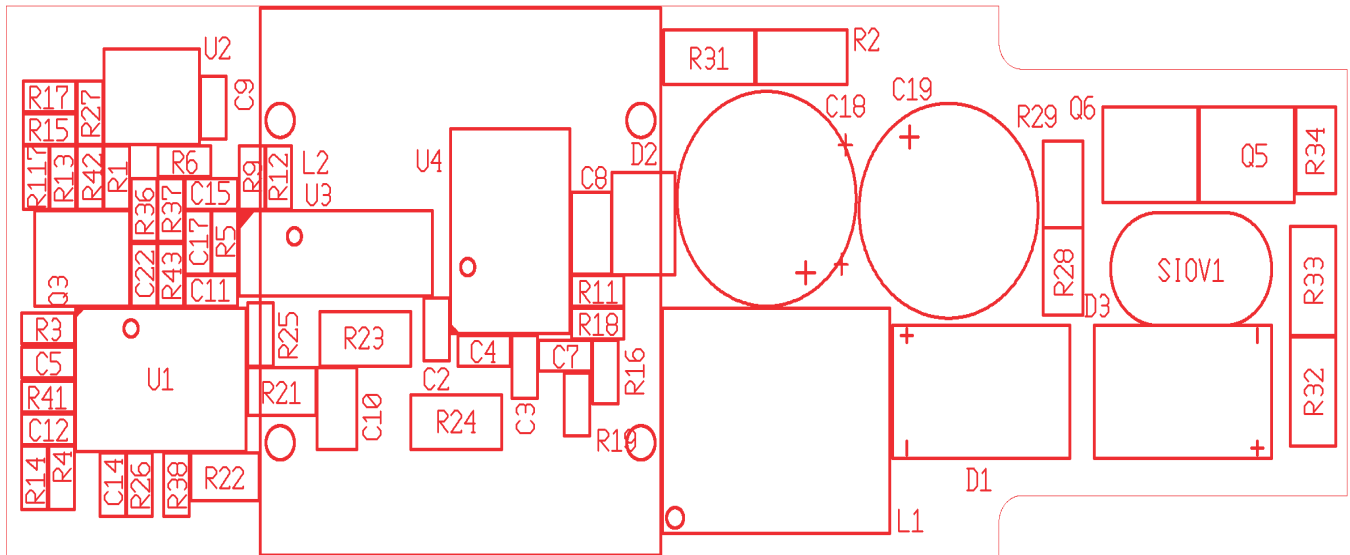

Figure 11. PSU Top Layer Assembly Drawing (top view)

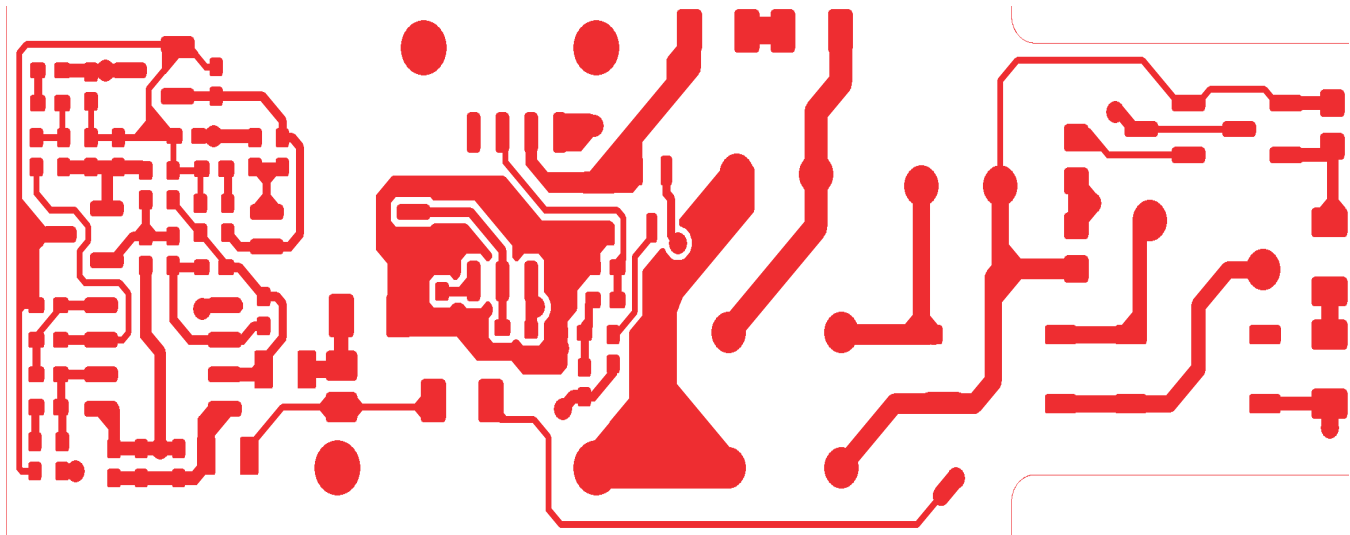

Figure 12. PSU Top Copper (top view)

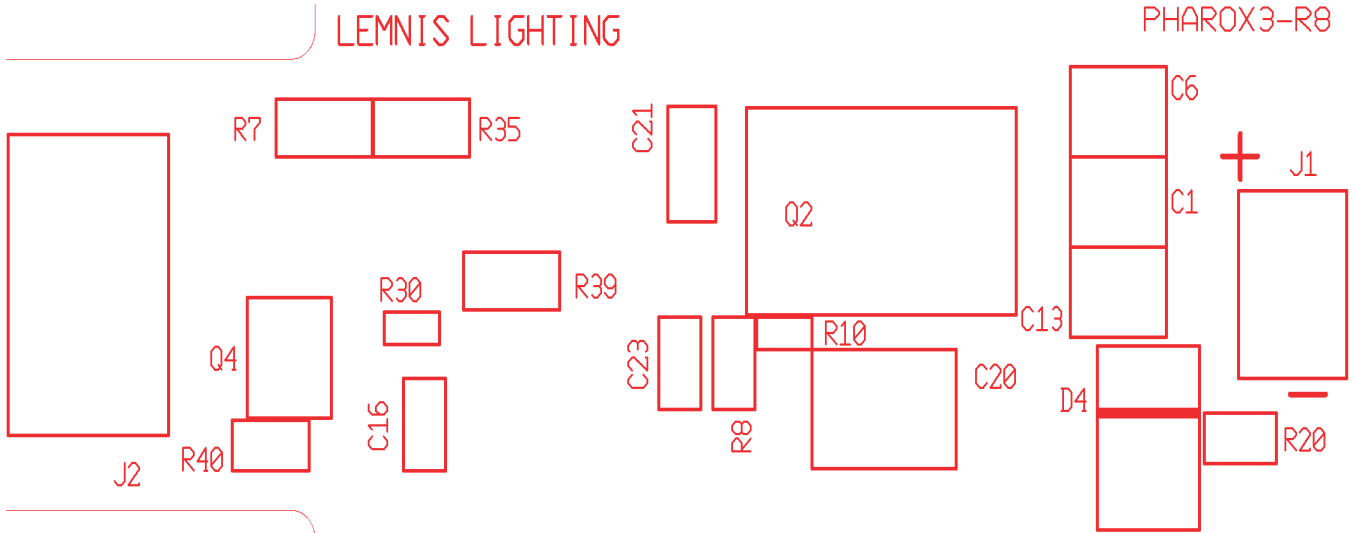

Figure 13. PSU Bottom Assembly Drawing (bottom view)

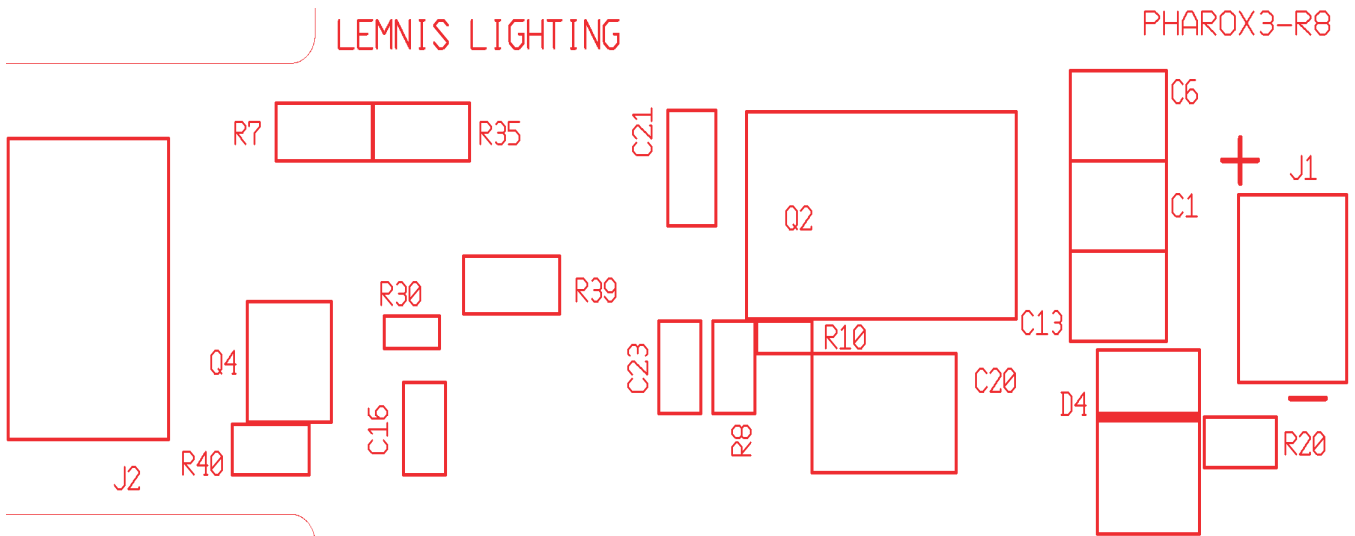

Figure 14. Bottom Copper (bottom view)

9 List of Materials

The EVM components list according to the schematic shown in [Figure 1](#)

Table 3. The EVM Components List

QTY	REFDES	DESCRIPTION	MFR	PART NUMBER
3	C1, C6, C13	Capacitor, ceramic, 1 μ F, 180 V, X7R, 10%, 1210	Std	Std
1	C10	Capacitor, ceramic, 22 nF, 180 V, X7R, 10%, 0805	Std	Std
3	C11, C14, C15	Capacitor, ceramic, 0.1 μ F, 16 V, X5R, 10%, 0402	Std	Std
2	C12, C17	Capacitor, ceramic, 10 nF, 50 V, X7R, 10%, 0402	Std	Std
1	C16	Capacitor, ceramic, 220 nF, 16 V, X7R, 10%, 0603	Std	Std
2	C18, C19	Capacitor, aluminum, 2.2 μ F, \pm 20%, 400 V, 8 mm x 11.5 mm	Nichicon	UCS2G2R2MPDAZH
3	C2, C3, C5	Capacitor, ceramic, 1 nF, 50 V, X7R, 10%, 0402	Std	Std
1	C20	Capacitor, ceramic, 1 nF, X1Y2, 5 kV, X7R, 10%, 1808	Std	Std
1	C21	Capacitor, ceramic, 82 pF, 1000 V, COG, 5%, 1206	Std	Std
1	C22	Capacitor, ceramic, 0.1 μ F, 180 V, X5R, 10%, 0402	Std	Std
1	C23	Capacitor, ceramic, 100 nF, 50 V, X7R, 10%, 0603	Std	Std
1	C4	Capacitor, ceramic, 330 pF, 50 V, X7R, 10%, 0402	Std	Std
1	C7	Capacitor, ceramic, 47 pF, 50 V, COG, 5%, 0402	Std	Std
1	C8	Capacitor, ceramic, 1 μ F, 25 V, X7R, 10%, 0805	Std	Std
1	C9	Capacitor, ceramic, 100 pF, 50 V, COG, 5%, 0402	Std	Std
2	D1, D3	Diode, bridge rectifier, 0.5 A, x00 V	Fairchild	MB6S
1	D2	Diode, dual , 250 mA, 70 V	Vishay-Liteon	BAW56GS08
1	D4	Diode, Schottky, 2 A, 60 V	STD	STD
1	L1	Inductor, common choke, \pm 10%	Würth	750310784
1	L2	Xfmr, flyback	Würth	750310334
1	Q2	MOSFET, N-channel, 800 V, 2.0 A, 2.7 Ω	Infineon	SPD02N80C3
1	Q3	MOSFET, N-channel, 60 V, 115 mA, 1.2 Ω	Diodes	2N7002
1	Q4	Trans, NPN	Diodes	FMMT458TA
2	Q5, Q6	Trans, NPN	Std	BC817-25

Table 3. The EVM Components List (continued)

QTY	REFDES	DESCRIPTION	MFR	PART NUMBER
1	R1	Resistor, chip, 560 k Ω , 1/16 W, 1%, 0402	Std	Std
1	R10	Resistor, chip, 560, 1/16 W, 1%, 0402	Std	Std
1	R12	Resistor, chip, 1.0 k Ω , 1/16 W, 5%, 0402	Std	Std
1	R13	Resistor, chip, 33.0 k Ω , 1/16 W, 1%, 0402	Std	Std
2	R14, R117	Resistor, chip, 4.70 k Ω , 1/16 W, 1%, 0402	Std	Std
1	R15	Resistor, chip, 1.50 k Ω , 1/16 W, 1%, 0402	Std	Std
1	R16	Resistor, chip, 4.7 Ω , 1/16 W, 5%, 0402	Std	Std
1	R17	Resistor, chip, 330 Ω , 1/16 W, 1%, 0402	Std	Std
1	R18	Resistor, chip, 68 k Ω , 1/16 W, 5%, 0402	Std	Std
2	R2, R31	Resistor, chip, 1.0 M Ω , 1/4 W, 5%, 1206	Std	Std
1	R20	Resistor, chip, 0.39 Ω , 1/10 W, 1%, 0805	Std	Std
2	R21, R22	Resistor, chip, 3.90 M Ω , 1/10 W, 1%, 0805	Std	Std
2	R23, R24	Resistor, chip, 10.0 M Ω , 1/4 W, 1%, 1206	Std	Std
2	R25, R38	Resistor, chip, 680 k Ω , 1/16 W, 1%, 0402	Std	Std
2	R26, R37	Resistor, chip, 470 k Ω , 1/16 W, 1%, 0402	Std	Std
1	R27	Resistor, chip, 2.49 k Ω , 1/16 W, 1%, 0402	Std	Std
1	R28	Resistor, chip, 27 Ω , 1/16 W, 5%, 0603	Std	Std
1	R29	Resistor, chip, 4.70 k Ω , 1/16 W, 1%, 0603	Std	Std
2	R3, R19	Resistor, chip, 8.20 k Ω , 1/16 W, 1%, 0402	Std	Std
1	R30	Resistor, chip, 22.0 k Ω , 1/16 W, 1%, 0402	Std	Std
2	R32, R33	Resistor, chip, 3.3 M Ω , 1/4 W, 5%, 1206	Std	Std
1	R34	Resistor, chip, 100 k Ω , 1/16 W, 1%, 0603	Std	Std
0	R7, R35	Resistor, chip, 1/4 W, 5%, 1206	Std	Std
1	R36	Resistor, chip, 270 k Ω , 1/16 W, 1%, 0402	Std	Std
1	R39	Resistor, chip, 47.0 k Ω , 1/4 W, 1%, 1206	Std	Std
2	R4, R9	Resistor, chip, 2.70 k Ω , 1/16 W, 1%, 0402	Std	Std
1	R40	Resistor, chip, 220 Ω , 1/16 W, 5%, 0603	Std	Std
1	R41	Resistor, chip, 1.20 M Ω , 1/16 W, 1%, 0402	Std	Std
1	R42	Resistor, chip, 1.50 M Ω , 1/16 W, 1%, 0402	Std	Std
1	R43	Resistor, chip, 39.0 k Ω , 1/16 W, 1%, 0402	Std	Std
2	R5, R11	Resistor, chip, 10.0 k Ω , 1/16 W, 1%, 0402	Std	Std
1	R6	Resistor, chip, 12.0 k Ω , 1/16 W, 1%, 0402	Std	Std
1	R8	Resistor, chip, 5.6 Ω , 1/16 W, 5%, 0603	Std	Std
1	SIOV1	Varistor, disk, 250 V, 1 W, T _A at 85°C	Epcos	SIOV-S05K250
1	U1	Dual Operational Amplifiers	TI	LM358AD
1	U2	Diode, Adjustable Shunt Regulator, 2.49 V to 36 V, 20 mA,	TI	TL431A
1	U3	High Isolation Voltage Photocoupler	CEL	PS2801C-1-A
1	U4	8-Pin, High-Efficiency, Offline LED Lighting Controller	TI	TPS92010
1	--	PCB, 60 mm x 20.6 mm x 1.62 mm	Any	HPA594
LED Load Board (HPA631)				
5	D1, D2, D3, D4, D5	HBLED, 0.7 A, 3.9 V	Cree	XPEWHT-L1-0000-00BE7

Evaluation Board/Kit Important Notice

Texas Instruments (TI) provides the enclosed product(s) under the following conditions:

This evaluation board/kit is intended for use for **ENGINEERING DEVELOPMENT, DEMONSTRATION, OR EVALUATION PURPOSES ONLY** and is not considered by TI to be a finished end-product fit for general consumer use. Persons handling the product(s) must have electronics training and observe good engineering practice standards. As such, the goods being provided are not intended to be complete in terms of required design-, marketing-, and/or manufacturing-related protective considerations, including product safety and environmental measures typically found in end products that incorporate such semiconductor components or circuit boards. This evaluation board/kit does not fall within the scope of the European Union directives regarding electromagnetic compatibility, restricted substances (RoHS), recycling (WEEE), FCC, CE or UL, and therefore may not meet the technical requirements of these directives or other related directives.

Should this evaluation board/kit not meet the specifications indicated in the User's Guide, the board/kit may be returned within 30 days from the date of delivery for a full refund. **THE FOREGOING WARRANTY IS THE EXCLUSIVE WARRANTY MADE BY SELLER TO BUYER AND IS IN LIEU OF ALL OTHER WARRANTIES, EXPRESSED, IMPLIED, OR STATUTORY, INCLUDING ANY WARRANTY OF MERCHANTABILITY OR FITNESS FOR ANY PARTICULAR PURPOSE.**

The user assumes all responsibility and liability for proper and safe handling of the goods. Further, the user indemnifies TI from all claims arising from the handling or use of the goods. Due to the open construction of the product, it is the user's responsibility to take any and all appropriate precautions with regard to electrostatic discharge.

EXCEPT TO THE EXTENT OF THE INDEMNITY SET FORTH ABOVE, NEITHER PARTY SHALL BE LIABLE TO THE OTHER FOR ANY INDIRECT, SPECIAL, INCIDENTAL, OR CONSEQUENTIAL DAMAGES.

TI currently deals with a variety of customers for products, and therefore our arrangement with the user **is not exclusive.**

TI assumes **no liability for applications assistance, customer product design, software performance, or infringement of patents or services described herein.**

Please read the User's Guide and, specifically, the Warnings and Restrictions notice in the User's Guide prior to handling the product. This notice contains important safety information about temperatures and voltages. For additional information on TI's environmental and/or safety programs, please contact the TI application engineer or visit www.ti.com/esh.

No license is granted under any patent right or other intellectual property right of TI covering or relating to any machine, process, or combination in which such TI products or services might be or are used.

FCC Warning

This evaluation board/kit is intended for use for **ENGINEERING DEVELOPMENT, DEMONSTRATION, OR EVALUATION PURPOSES ONLY** and is not considered by TI to be a finished end-product fit for general consumer use. It generates, uses, and can radiate radio frequency energy and has not been tested for compliance with the limits of computing devices pursuant to part 15 of FCC rules, which are designed to provide reasonable protection against radio frequency interference. Operation of this equipment in other environments may cause interference with radio communications, in which case the user at his own expense will be required to take whatever measures may be required to correct this interference.

EVM Warnings and Restrictions

It is important to operate this EVM within the input voltage range of 185 V to 265 V and the output voltage range of .

Exceeding the specified input range may cause unexpected operation and/or irreversible damage to the EVM. If there are questions concerning the input range, please contact a TI field representative prior to connecting the input power.

Applying loads outside of the specified output range may result in unintended operation and/or possible permanent damage to the EVM. Please consult the EVM User's Guide prior to connecting any load to the EVM output. If there is uncertainty as to the load specification, please contact a TI field representative.

During normal operation, some circuit components may have case temperatures greater than 60° C. The EVM is designed to operate properly with certain components above 60° C as long as the input and output ranges are maintained. These components include but are not limited to linear regulators, switching transistors, pass transistors, and current sense resistors. These types of devices can be identified using the EVM schematic located in the EVM User's Guide. When placing measurement probes near these devices during operation, please be aware that these devices may be very warm to the touch.

Mailing Address: Texas Instruments, Post Office Box 655303, Dallas, Texas 75265
Copyright © 2011, Texas Instruments Incorporated

IMPORTANT NOTICE

Texas Instruments Incorporated and its subsidiaries (TI) reserve the right to make corrections, modifications, enhancements, improvements, and other changes to its products and services at any time and to discontinue any product or service without notice. Customers should obtain the latest relevant information before placing orders and should verify that such information is current and complete. All products are sold subject to TI's terms and conditions of sale supplied at the time of order acknowledgment.

TI warrants performance of its hardware products to the specifications applicable at the time of sale in accordance with TI's standard warranty. Testing and other quality control techniques are used to the extent TI deems necessary to support this warranty. Except where mandated by government requirements, testing of all parameters of each product is not necessarily performed.

TI assumes no liability for applications assistance or customer product design. Customers are responsible for their products and applications using TI components. To minimize the risks associated with customer products and applications, customers should provide adequate design and operating safeguards.

TI does not warrant or represent that any license, either express or implied, is granted under any TI patent right, copyright, mask work right, or other TI intellectual property right relating to any combination, machine, or process in which TI products or services are used. Information published by TI regarding third-party products or services does not constitute a license from TI to use such products or services or a warranty or endorsement thereof. Use of such information may require a license from a third party under the patents or other intellectual property of the third party, or a license from TI under the patents or other intellectual property of TI.

Reproduction of TI information in TI data books or data sheets is permissible only if reproduction is without alteration and is accompanied by all associated warranties, conditions, limitations, and notices. Reproduction of this information with alteration is an unfair and deceptive business practice. TI is not responsible or liable for such altered documentation. Information of third parties may be subject to additional restrictions.

Resale of TI products or services with statements different from or beyond the parameters stated by TI for that product or service voids all express and any implied warranties for the associated TI product or service and is an unfair and deceptive business practice. TI is not responsible or liable for any such statements.

TI products are not authorized for use in safety-critical applications (such as life support) where a failure of the TI product would reasonably be expected to cause severe personal injury or death, unless officers of the parties have executed an agreement specifically governing such use. Buyers represent that they have all necessary expertise in the safety and regulatory ramifications of their applications, and acknowledge and agree that they are solely responsible for all legal, regulatory and safety-related requirements concerning their products and any use of TI products in such safety-critical applications, notwithstanding any applications-related information or support that may be provided by TI. Further, Buyers must fully indemnify TI and its representatives against any damages arising out of the use of TI products in such safety-critical applications.

TI products are neither designed nor intended for use in military/aerospace applications or environments unless the TI products are specifically designated by TI as military-grade or "enhanced plastic." Only products designated by TI as military-grade meet military specifications. Buyers acknowledge and agree that any such use of TI products which TI has not designated as military-grade is solely at the Buyer's risk, and that they are solely responsible for compliance with all legal and regulatory requirements in connection with such use.

TI products are neither designed nor intended for use in automotive applications or environments unless the specific TI products are designated by TI as compliant with ISO/TS 16949 requirements. Buyers acknowledge and agree that, if they use any non-designated products in automotive applications, TI will not be responsible for any failure to meet such requirements.

Following are URLs where you can obtain information on other Texas Instruments products and application solutions:

Products

Audio	www.ti.com/audio
Amplifiers	amplifier.ti.com
Data Converters	dataconverter.ti.com
DLP® Products	www.dlp.com
DSP	dsp.ti.com
Clocks and Timers	www.ti.com/clocks
Interface	interface.ti.com
Logic	logic.ti.com
Power Mgmt	power.ti.com
Microcontrollers	microcontroller.ti.com
RFID	www.ti-rfid.com
RF/IF and ZigBee® Solutions	www.ti.com/lprf

Applications

Communications and Telecom	www.ti.com/communications
Computers and Peripherals	www.ti.com/computers
Consumer Electronics	www.ti.com/consumer-apps
Energy and Lighting	www.ti.com/energy
Industrial	www.ti.com/industrial
Medical	www.ti.com/medical
Security	www.ti.com/security
Space, Avionics and Defense	www.ti.com/space-avionics-defense
Transportation and Automotive	www.ti.com/automotive
Video and Imaging	www.ti.com/video
Wireless	www.ti.com/wireless-apps

TI E2E Community Home Page

e2e.ti.com

Mailing Address: Texas Instruments, Post Office Box 655303, Dallas, Texas 75265
Copyright © 2011, Texas Instruments Incorporated